



Department of Defense  
Implementation Plan  
for  
Advanced Distributed Learning

May 19, 2000

Office of the Deputy Under Secretary of Defense (Readiness)  
Director for Readiness and Training  
4000 Defense Pentagon, Room 1C757  
Washington, DC 20301-4000

# Report Documentation Page

*Form Approved*  
*OMB No. 0704-0188*

Public reporting burden for the collection of information is estimated to average 1 hour per response, including the time for reviewing instructions, searching existing data sources, gathering and maintaining the data needed, and completing and reviewing the collection of information. Send comments regarding this burden estimate or any other aspect of this collection of information, including suggestions for reducing this burden, to Washington Headquarters Services, Directorate for Information Operations and Reports, 1215 Jefferson Davis Highway, Suite 1204, Arlington VA 22202-4302. Respondents should be aware that notwithstanding any other provision of law, no person shall be subject to a penalty for failing to comply with a collection of information if it does not display a currently valid OMB control number.

1. REPORT DATE <b>19 MAY 2000</b>	2. REPORT TYPE	3. DATES COVERED <b>00-00-2000 to 00-00-2000</b>			
4. TITLE AND SUBTITLE <b>Department of Defense Implementation Plan for Advanced Distributed Learning</b>		5a. CONTRACT NUMBER			
		5b. GRANT NUMBER			
		5c. PROGRAM ELEMENT NUMBER			
6. AUTHOR(S)		5d. PROJECT NUMBER			
		5e. TASK NUMBER			
		5f. WORK UNIT NUMBER			
7. PERFORMING ORGANIZATION NAME(S) AND ADDRESS(ES) <b>Office of the Deputy Under Secretary of Defense (Readiness), Director for Readiness and Training, 4000 Defense Pentagon, Room 1C757, Washington, DC, 20301-4000</b>		8. PERFORMING ORGANIZATION REPORT NUMBER			
9. SPONSORING/MONITORING AGENCY NAME(S) AND ADDRESS(ES)		10. SPONSOR/MONITOR'S ACRONYM(S)			
		11. SPONSOR/MONITOR'S REPORT NUMBER(S)			
12. DISTRIBUTION/AVAILABILITY STATEMENT <b>Approved for public release; distribution unlimited</b>					
13. SUPPLEMENTARY NOTES					
14. ABSTRACT					
15. SUBJECT TERMS					
16. SECURITY CLASSIFICATION OF:			17. LIMITATION OF ABSTRACT <b>Same as Report (SAR)</b>	18. NUMBER OF PAGES <b>111</b>	19a. NAME OF RESPONSIBLE PERSON
a. REPORT <b>unclassified</b>	b. ABSTRACT <b>unclassified</b>	c. THIS PAGE <b>unclassified</b>			

## *Perspectives from Key Department of Defense Leaders*

“America's military services have a long tradition and a well-deserved reputation of world-class training. For example, having highly trained service members was key to our overwhelming success in Operation Desert Storm. We recognize that, as in the past, training will be the key to our success in future military operations. That is why training remains a high priority for the U.S. Armed Forces. It is the key to their readiness. It is the reason why our servicemen and servicewomen are the most capable in the world today. As good as we are at training, however, we are always vigilant in seeking opportunities to become better. The Department of Defense's vision is to ensure that Department of Defense personnel have access to the highest quality education and training that can be tailored to their needs and delivered cost effectively, anytime and anywhere.”

**William S. Cohen, Secretary of Defense**

Department of Defense Training Technology Vision,  
provided to the Vice President of the United States,  
January 7, 1999

“We have a department-wide strategy, Advanced Distributed Learning (ADL), which calls for the full exploitation of technologies to support quality education and training in disciplines of national priority. Key to this strategy is widespread collaboration with other federal agencies, academia, and the private sector. As a result of extensive cooperative efforts across the public and private sectors, on January 31, 2000, my staff released an initial set of ADL specifications and guidelines. They will provide the foundation for leveraging learning technologies to prepare a skilled workforce for the future. Outstanding opportunities exist for the public and private sectors to work together to enhance dramatically the quality of American education, the competitiveness of its workforce, and the readiness of our military forces.”

**Rudy de Leon, Deputy Secretary of Defense**

Letter to the Honorable John B. Larson,  
House of Representatives,  
April 18, 2000

“Joint doctrine is the engine of change and is the foundation of all military operations. We are transforming the joint doctrine development program to ensure that we get doctrine into the warfighters' hands in a timely manner. Technology will play a leading role in transforming joint doctrine. The Internet and CD-ROM based distributed learning methodology employed to enhance doctrine awareness promises quality doctrine education to every member of the U.S. military. Information and hands-on training formerly available only to those people able to participate in resident education now will be available to all participants.”

**General Henry H. Shelton, Chairman Joint Chiefs of Staff**

Statement before the 106<sup>th</sup> Congress, Committee on Armed Services,  
United States Senate,  
February 8, 2000

Department of Defense  
Implementation Plan  
for  
Advanced Distributed Learning

Office of the Deputy Under Secretary of Defense (Readiness)  
Director for Readiness and Training  
4000 Defense Pentagon, Room 1C757  
Washington, DC 20301-4000



# Table of Contents

	<u>Page</u>
Executive Summary	ES-1
1.0 Introduction	1
2.0 Implementing Responsibilities and Roles	1
2.1 Office of the Secretary of Defense	1
2.2 Department of Defense Components	1
2.3 Education and Training Steering Committee	2
2.3.1 Total Force Advanced Distributed Learning Action Team	3
2.3.2 Joint Services Collaborative Action Team	3
2.4 Joint Staff	3
2.5 U.S. Joint Forces Command	4
2.6 Military Services	5
2.6.1 Army	5
2.6.2 Navy	6
2.6.3 USMC	7
2.6.4 USAF	8
2.7 National Guard Bureau	9
2.8 The Coast Guard	10
3.0 Implementing Common Specifications	11
3.1 Sharable Courseware Object Reference Model (SCORM) Background	11
3.2 Technical Working Group (TWG)	12
3.3 Sharable Courseware Object Reference Model Status	13
3.4 Setting and Implementing Courseware Standards	14
3.5 ADL Co-Laboratory	14
3.5.1 Coordinate and Perform Research and Development	16
3.5.2 Serve as a Test Bed	17
3.5.3 Provide Learning Technology Demonstrations	18
3.5.4 Provide a Database for Federal Training and Resource Center	18
3.5.5 Provide a Resource Center and Help Desk Function	19
3.6 Examples of Recent Joint ADL Prototypes	19
3.6.1 Joint Doctrine Training Model	19
3.6.2 Joint Electronic Library	19
3.6.3 Joint Doctrine Electronic Information System	19
3.6.4 Doctrine Networked Education and Training	20
3.6.5 Crisis Action Planning Tutored On-line Resource	20
3.6.6 Joint Force Employment Interactive CD-ROM Wargame	21
3.6.7 Joint Doctrine Operations Laboratory	21
3.6.8 Joint Virtual Learning Environment	21
3.6.9 Future Joint Training System	22
3.7 Regional Centers Global Distributed Learning Data Services Network	22
3.8 Joint ADL Network Architecture	23
4.0 Implementing Advanced Distributed Learning	24

4.1 Task One – Identifying Requirements and Resources	24
4.1.1 Readiness	24
4.1.2 Program Review	25
4.1.3 Data Assessments	25
4.1.3.1 Army	26
4.1.3.2 Navy	29
4.1.3.3 USMC	30
4.1.3.4 USAF	31
4.1.3.5 National Guard Bureau	32
4.2 Task Two – Setting Goals and Milestones	34
4.2.1 Defense Courses for Conversion	34
4.2.2 Joint Staff	35
4.2.3 Joint Forces Command	39
4.2.4 Army	40
4.2.5 Navy	41
4.2.6 USMC	42
4.2.7 USAF	43
4.2.8 National Guard Bureau	44
4.3 Task Three - Monitoring and Measuring Progress	45
4.4 Task Four - Establishing a Science and Technology Base	46
5.0 Implementation Issues and Potential Barriers	53
5.1 Education and Training Institutions	53
5.2 Collaboration Incentives	53
5.3 Resources	53
5.4 Faculties	53
5.5 Policies	53
5.6 Access	53
5.7 Information Security	53
5.8 Interoperable Learning Management System	53
5.9 Legislative	54
6.0 Future Implementation Activities and Goals	54
Appendices:	
1 Program Investment	57
2 Component Course Conversion Projection	59
3 Sharable Courseware Object Reference Model (SCORM)	72
4 Joint Advanced Distributed Learning Network Architecture	80
5 Joint Professional Military Education	87
6 Glossary	91

## List of Figures

Figure 1. Advance Distributed Learning Management Process	2
Figure 2. Evolution of Web-based Learning Technologies	13
Figure 3. ADL Co-Lab Concept of Operations	16
Figure 4. Joint Virtual Learning Environment (JVLE) Implementation Scenarios	22
Figure 5. Joint ADL Network Model	24
Figure 6. The National Guard's "GuardNet XXI Network"	34
Figure 7. Current Goals for Course Conversion	35
Figure 8. DUSD (S&T) Focus on Cognitive Readiness	46
Figure 9. "ADL in 2012" Key Research Areas	48





# Department of Defense Implementation Plan for Advanced Distributed Learning

## Executive Summary

**Vision.** The Advanced Distributed Learning (ADL) Initiative is providing a federal framework for using distributed learning to provide high-quality education and training, that can be tailored to individual needs and delivered cost-effectively, anytime and anywhere.

**Background.** The Department of Defense (DoD) has developed its ADL Strategic Plan that describes how it expects to use information, computing, and communications technologies to modernize military education, training, and performance support. Importantly, the ADL Initiative's underpinnings and applications are germane not only to the Department of Defense, but to other government organizations, academia, and the private sector, as well. The ADL Initiative, therefore, is a cooperative effort between the public and private sectors to develop and share common standards, reusable learning tools, and content.

The department's education and training programs must prepare the total force to meet national security challenges and opportunities. Training technologies, those available today as well as those on the horizon, provide an opportunity to help us achieve that goal. We must be able to train our forces effectively and rapidly, whether they are at home stations, en route, or in the theater of operations. The tools under development through the ADL Initiative will add another level of learning capability and the opportunity to strengthen our already impressive inventory of learning technologies, techniques, and procedures.

The ADL Initiative, under which this Department of Defense Implementation Plan for Advanced Distributed Learning has been developed, is a complex and dynamic undertaking. It is designed to meet the goals of the department, the Congress, and the Office of Science and Technology Policy (OSTP), as well as the requirements of the warfighter and the DoD learner. This Implementation Plan is a living roadmap that will change over time.

**Top-Level Direction.** This Implementation Plan describes Department of Defense's approach to carrying out the "*Department of Defense Strategic Plan for Advanced Distributed Learning*" (a report submitted to the 106<sup>th</sup> Congress on April 30, 1999), and includes information about specific ADL prototypes, program milestones, and associated resources. The Strategic Plan provided initial answers to direction from Congress, the Secretary and Deputy Secretary of Defense, the Under Secretary of Defense for Personnel and Readiness, the Office of Science and Technology Policy (OSTP), and the National Partnership for Reinvention of Government. Those directions, in sum, were to develop a Department of Defense strategy for Advanced Distributed Learning (defined as education,

training and performance support) and assist the remainder of the U.S. Government in planning for the use of advanced distributed learning technologies, tools and methodologies.

This Plan is in consonance with Executive Order 13111, *Using Technology to Improve Training Opportunities for Federal Government Employees* (January 12, 1999), and with the vision statements of the Secretary of Defense and the Chairman of the Joint Chiefs of Staff. It draws on assemblies of experts on education and training within the department, who have met in multiple fora. Counsel has been sought and taken from both public and private sectors -- academia, industry, and other government organizations. This Implementation Plan is based on resource expectations and may have to be modified to meet actual funding provided.

**Definitions and Terms.** This Implementation Plan uses the following definitions and terms:

- **Learning** is defined as the acquisition of knowledge, skills, behaviors, and attitudes (through the integration of education, training, and performance support in a comprehensive, mutually supportive system).
- **Distributed Learning** (*encompassing programs also referred to as distance learning*) is defined as structured learning that takes place without requiring the physical presence of an instructor. Distributed learning is synchronous and/or asynchronous learning mediated with technology and may use one or more of the following media: audio/videotapes, CD-ROMs, audio/videoteletraining, correspondence courses, interactive television, and video conferencing.
- **Advanced Distributed Learning** is an evolution of distributed learning (distance learning) that emphasizes collaboration on standards-based versions of reusable objects, networks, and learning management systems, yet may include some legacy methods and media.

**Major Implementing Actions and Significant Accomplishments.** There have been a number of significant department-wide implementing actions since the department published its Strategic Plan for Advanced Distributed Learning in April 1999. The Under Secretary of Defense for Personnel and Readiness (USD(P&R)) has led a collaborative effort with the Services, Joint Staff, and other Department of Defense components to produce ADL policy, plans, and procedures for developing and implementing advanced distributed learning technologies across the department. The following specific actions have occurred over the last twelve months:

- **Established the Education and Training Steering Committee.** As part of the effort to provide direction and oversight by senior leaders, the department established the Education and Training Steering Committee to provide management policy oversight as well as a process to collaborate, to avoid redundancies, and to establish and monitor goals, objectives and guidelines.

- **Conducted Comprehensive Reviews of Distance Learning Programs.** The department has conducted multiple reviews, as directed by the Deputy Secretary of Defense, the Under Secretary of Defense for Personnel and Readiness, and the Under Secretary of Defense (Comptroller), of existing distance learning programs, plans, resources and supporting data. Data developed as a result of these reviews are contained within this Implementation Plan. These reviews highlighted the need for direct and continuous oversight and guidance by senior leaders as the ADL program matures.
- **Reserve Component Distributed Learning.** The Assistant Secretary of Defense for Reserve Affairs (ASD/RA) chartered a Reserve Component Distributed Learning Program Integrated Process Team (IPT) to assess legal and departmental policy impediments to implementing advanced distributed learning practices for the reserve components. The IPT, comprised of ASD/RA and Active and Reserve Component personnel, has concluded its nine-month study and has proposed the publication of department-wide policies that would provide critical implementing guidelines for the reserve components' distributed learning programs. The policies would delineate how reservists could complete collective and individual training and/or educational requirements via advanced distributed learning methodologies. They would also "identify" what learning is "required" for Reserve Component personnel who complete training or education approved for delivery via advanced distributed learning technologies.
- **Co-Developed Common Internationally-Recognized Specifications.** On January 31, 2000, the Department of Defense released the Sharable Courseware Object Reference Model (SCORM) for public testing, evaluation, and comment. The release of the SCORM marked the culmination of extensive cooperative efforts across the public and private sectors. This common specification for instructional software will promote interoperability and reuse across the department, the federal government, academia, the private sector, and beyond. The SCORM is a *sine qua non* -- a key technical enabler for advanced distributed learning.
- **Established the ADL Co-Laboratory.** The department established the ADL Co-Laboratory in Alexandria, Virginia in 1999 to foster partnerships, resource sharing, and large-scale collaboration. Its functions include promoting the collaborative research, development, and assessment of the common tools, standards, content, and guidelines for the ADL Initiative. Its most critical function is to develop, evaluate, and promote ADL standards, as directed by the President and Secretary of Defense. As the focal point for the SCORM specification, the ADL Co-Lab will provide a forum and technical support for developing and assessing prototype tools and content that adhere to the evolving specification.
- **Expanded the ADL Co-Laboratory Structure.** Two ADL Co-Lab nodes have been established, in Orlando, FL and Madison, WI. The Joint Co-Lab node in Orlando was established to promote collaborative and rapid development of ADL prototypes and ADL system acquisitions, principally among the department's training systems

development components. In January 2000, an “independent” ADL Co-Lab was established, in partnership with the University of Wisconsin System and the Wisconsin Technical College System, to promote collaborative development, demonstration, and evaluation of next-generation learning technologies that enable distributed learning, principally among academic institutions. All three Co-Labs work together to share research, subject-matter expertise, common tools, and course content through a virtual ADL Co-Lab network.

- **Issued Challenge to Collaboratively Develop Prototypes.** On March 28, 2000, USD (P&R) announced to the Department of Defense components the release of the Sharable Courseware Object Reference Model (SCORM) and challenged the department’s education and training developers “to work collaboratively, across the department, academia, and the private sector, to develop ADL prototypes and content that conform to the new SCORM specification.”
- **Provided Incentives for Collaborative Development of ADL Prototypes.** In January 2000, the Joint Co-Lab issued a “focus call” for ADL prototype proposals. Twenty-nine proposals were received from education and training developers across the department. Incentive funds were awarded in April 2000 to the nineteen proposals that placed the greatest emphasis upon collaboration and adherence to the new SCORM specification. ADL prototype developers will demonstrate the interoperability and reuse of their ADL course modules at a number of “plugfest” or interoperability demonstrations to be hosted by the ADL Co-Labs throughout the year.
- **Issued Defense Planning Guidance.** In the FY 2002-2007 Defense Planning Guidance, the Secretary of Defense directed the Department of Defense components to: develop and maintain strategic training plans that guide Department of Defense training programs and demonstrate how they take full advantage of learning technologies to provide training anytime and anywhere; identify in their Program Objective Memoranda, in specific distributed learning Program Elements, all distributed learning programs and resources, including research and development; and develop coalition-based global education and training opportunities through the ADL Initiative.
- **Defined an ADL Science and Technology Program.** As part of the department’s “Cognitive Readiness” Science and Technology Focus Area, the Deputy Under Secretary of Defense for Science and Technology reviewed and studied the department’s key research to accelerate the development of the Department of Defense’s ADL capability and to develop a research agenda to produce that capability by the year 2012. This analysis identified four key research areas that address the full spectrum of educational design activities, including requirements analysis and course development, as well as delivery and assessment. The four areas are intelligent computer-aided instruction, authoring tools, distributed simulations, and dynamic learning management.
- **Provided a Report to the Presidential Task Force on Federal Training Technology.** In response to Executive Order 13111, the Department of Defense led a collaborative effort with other federal agencies and the private sector to develop common

specifications and standards for technology-based learning that could be used to support federal and national education and training needs. The department provided a final report, entitled “Establishing a Federal Framework For Distributed Learning,” to the President’s Task Force on Federal Training Technology in March 2000. In addition to making the SCORM specification available to other federal agencies, this report encouraged the federal agencies to participate in collaborative development efforts through the ADL Co-Laboratory in Alexandria, Virginia.

**Future Activities and Goals.** Department of Defense’s current focus is to work through its Education and Training Steering Committee to set scheduling goals for the next two years for converting courses, as identified by the components, in accordance with the ADL SCORM. In parallel we will continue to seek the support of key leaders throughout the department to assist in adopting and mandating key and challenging transformational actions as we create the future learning environment -- one that is learner-centric and where knowledge is available anywhere, anytime. An essential element of this process will be the continuing development of specific ADL learning prototypes to demonstrate the efficiency and effectiveness of advanced distributed learning in achieving the Secretary’s vision. The department will be making planned improvements to the SCORM, facilitating its adoption by the appropriate international standards-granting organizations as a standard, and assisting its incorporation into commercial products. The ADL Co-Laboratories will play an essential role, by helping others incorporate ADL compliance into the design of course content and by assessing the costs and benefits of ADL-compliant prototypes.

### **Key Goals and Milestones**

#### **Spring to Winter 2000**

- Conduct a series of “plugfest” events to test, validate, and refine the SCORM
- Complete development of SCORM compliance-testing software
- Encourage collaborative development across the Department of Defense, academia, and the private sector through active involvement in the ADL Co-Labs
- Encourage voluntary compliance with the SCORM in course development
- Encourage vendors to incorporate SCORM V1.0 into their next product cycle
- Release Version 2.0 in early Fall 2000
- Work with standards groups for SCORM adoption
- Staff a plan for joint DL architecture
- Complete the development of SCORM ADL rapid-prototypes

#### **Winter 2001**

- Assess whether there should be an acquisition policy decision for mandatory compliance with SCORM

#### **Winter 2008**

- All existing courses slated for conversion are SCORM-compliant

#### **Winter 2010**

- Joint Vision 2010 goal of achieving “information superiority” is enabled through an ADL capability of providing the right information and knowledge anywhere, anytime

**The Big Picture - ADL in Context.** The ADL Initiative is the Department of Defense’s principal vehicle for developing a broad range of plans and programs that use advanced communications and learning technologies to modernize how we will educate and train U.S. armed forces.

As mentioned at the outset, ADL’s primary goal is to implement the Secretary of Defense’s training vision -- to provide access to the highest quality education and training that can be tailored to individual needs and delivered cost-effectively, anytime and anywhere. The underpinnings of ADL are germane to other government organizations, academia, and the private sector as well. As such, the department has designed the ADL Initiative to be a collaborative effort between the public and private sectors to develop the common standards, tools, and learning content that are critical to the future learning environment.

Advanced technologies are changing how people live their lives and do business -- not just how they learn. Moreover, the pace of technological change is expected to remain extremely rapid for the foreseeable future. This presents a challenge to the department as it strives to apply learning technologies cost-effectively. While we have made enormous progress in a short period of time, we are committed to accelerating that progress.

If we are to rely heavily on networked communications, we must ensure security and protect personal privacy. If learning objects are to be shared, reused, and marketed, we must protect intellectual property rights. If we are to take full advantage of such technologies, we must fundamentally change how we do business; and this means we must change organizational structures, reengineer budget processes, and provide incentives to enable and motivate change.

The department recognizes that the power to learn (through education, training, and performance support) is critical to making U.S. service members and armed forces ready to carry out their missions. This “Department of Defense Implementation Plan for Advanced Distributed Learning” reflects the department’s commitment to building the learning environment of the future.

# Department of Defense Implementation Plan for Advanced Distributed Learning

## 1.0 Introduction

The purpose of the Department of Defense Implementation Plan for Advanced Distributed Learning is to apply the Department of Defense Strategy for ADL to meet the needs of the U.S. Armed Forces for the next millennium and to address the specific directions and focus provided by various mission-need statements. The capabilities needed in our Armed Forces of the future are most clearly defined in the Secretary of Defense's *Training Technology Vision*, the Chairman of the Joint Chief's *Joint Vision 2010 (JV 2010)*, and *Joint Professional Military Education 2010 (JPME 2010)*. The goals of these vision statements are further explained and underscored by Executive Order 13111 and congressional tasking. They have provided the *why*; this Plan provides the *how much, when and how*.

## 2.0 Implementing Responsibilities and Roles

2.1 **Office of the Secretary of Defense.** The Deputy Under Secretary of Defense for Readiness is responsible to the Secretary of Defense for department policy involving military education and training. The Director of Readiness and Training is responsible for and shall manage oversight of the Department of Defense components' (organizations and commands subordinate to the Secretary of Defense) implementation of this Plan and the Strategic Plan that together make up the department's strategy for training readiness in the JV 2010 environment. The Deputy Under Secretary for Readiness is responsible for establishing and chairing a Department of Defense Education and Training Steering Committee (ETSC), hereafter referred to as the Committee, composed of one general or flag-officer each, from the Joint Staff, the Joint Professional Military Education System, United States Joint Forces Command, each military service, the United States Marine Corps, United States Coast Guard, each reserve component, selected Defense Agencies and selected members from the staff of the Secretary of Defense. The purpose of the Committee is to provide executive policy and programmatic oversight and guidance for the department's implementation of ADL and the creation of an anywhere, anytime learning environment.

2.2 **Department of Defense Components.** The Department of Defense components and the military services are responsible for identifying and documenting requirements and resources needed to implement ADL initiatives within their respective service, Joint, or Agency organizations, for implementing their ADL Programs, and for working with other agencies to identify opportunities to share products and lessons learned, and leverage resources. The military services are responsible for appointing a general or flag rank officer to sit on the Education and Training Steering Committee (ETSC) to represent his/her education and/or training component of that service in all matters that come before the Committee. The Director of the Joint Staff is responsible for appointing a Joint Staff general or flag-rank officer



to sit on the Committee to represent the Chairman of the Joint Chiefs of Staff (CJCS) and is responsible for appointing a general or flag-rank officer from the Joint Professional Military Education System to represent the Joint Professional Military Education (JPME) community. The Commander-in-Chief, United States Joint Forces Command is responsible for appointing a general or flag-rank officer to sit on the Committee as a representative of the joint community in accordance with the Unified Command Plan.

2.3 **Education and Training Steering Committee (ETSC).** The Committee will advise and assist the Secretary of Defense on all aspects of Advanced Distributed Learning with the goal of ensuring that Department of Defense personnel have access to cost-effective, high-quality education and training, tailored to needs, whenever and wherever required. The Committee is expected to meet quarterly to collaboratively integrate the efforts of the organizations and headquarters supporting service or Joint, individual and collective training and education (service, Joint or Agency-specific institutional training or professional education). The first meeting of the Committee occurred February 23, 2000. This initial meeting provided an opportunity to hear and to integrate the representative views and perspectives of the Interservice Training Review Organization (ITRO), the military services' senior service training officials, and the Military Education Coordination Conference (MECC), the body responsible to the Chairman of the Joint Chiefs of Staff for Joint Professional Military Education.

## ADL Management Process

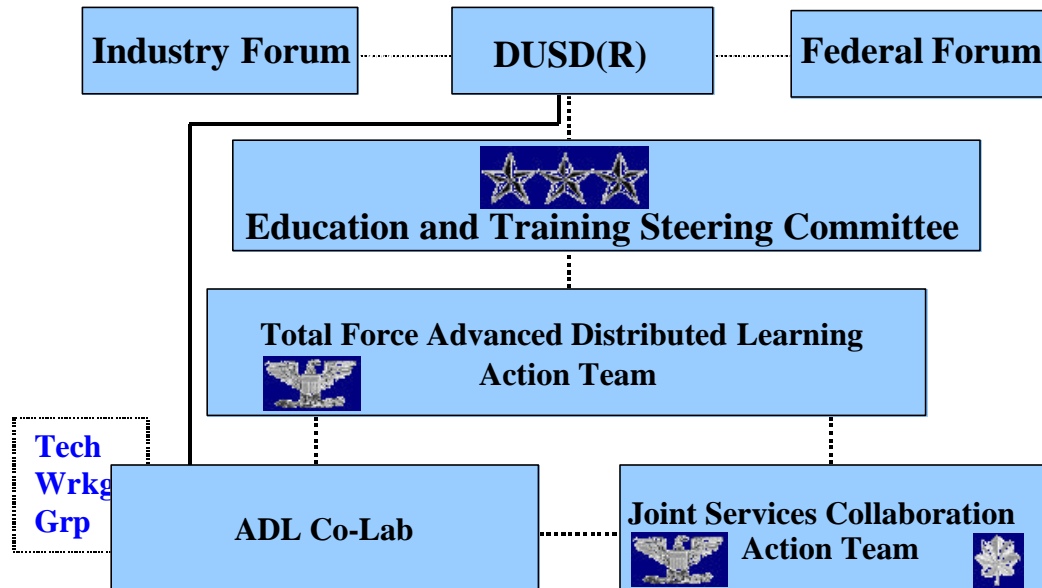

**Figure 1.** Advanced Distributed Learning Management Process

2.3.1 **Total Force Advanced Distributed Learning Action Team.** The Committee will use the standing Total Force Advanced Distributed Learning Action Team

(TFADLAT) as its working group to advise and assist the Committee on the institutionalization of the Advanced Distributed Learning Initiative. A DUSD(R) representative chairs the TFADLAT, which has membership from each service, each reserve component, the Joint Staff, OSD, U.S. Joint Forces Command, and Defense Agencies. The TFADLAT advises and assists the Secretary of Defense, Joint Staff, Services, and Defense Agencies on all aspects of advanced distributed learning. The TFADLAT:

- Serves as the Department of Defense focal point for advanced distributed learning practices and procedures;
- Provides oversight of advanced distributed learning content and courseware development and implementation;
- Provides a forum for discussion and resolution of practical issues in advanced distributed learning;
- Drafts, reviews, researches, evaluates, coordinates, and recommends policies for the Education and Training Steering Committee;
- Recommends funding and Research and Development priorities; and,
- Promotes collaboration.

**2.3.2 Joint Services Collaboration Action Team.** The Committee will use the newly proposed Joint Services Collaborative Action Team (JSCAT) to identify courses or content that can be developed collaboratively and shared across the Department of Defense learning community to avoid duplication and reduce costs. JSCAT membership will consist of one representative from each military service and other Department of Defense components that are developing ADL courseware and content. The JSCAT will appoint a representative to the TFADLAT to advise them on an agreed-upon list of courses that are planned and programmed for conversion by the Department of Defense components. The JSCAT will also provide this report to the Interservice Training Review Organization (ITRO) and the Military Education Coordination Conference (MECC). Reports will cover conversions for the current and following fiscal years and a snapshot of conversions planned for the outyears of the program objective memorandums.

**2.4 Joint Staff.** The Joint Staff oversees the Joint Professional Military Education (JPME) System. Policy for JPME and interfaces to the Professional Military Education (PME) Systems of the Military Departments are contained in Chairman of the Joint Chiefs of Staff Instruction CJCSI 1800.01, the Officer Professional Military Education Policy. The Joint Staff also oversees the Joint Training System via CJCSI 3500-01A, Joint Training System Policy for the Armed Forces of the United States. The Joint Staff oversees the Joint Command, Control, Communications, Computers, and Intelligence (C4I) Education and Training System, including special programs at the Naval Postgraduate School, the Armed Forces Staff College, and the National Defense University. The Joint Staff will coordinate and integrate ADL Initiatives with U.S. Joint Forces Command and the National Defense University.

2.5 **U.S. Joint Forces Command.** Under Unified Command Plan 99 (UCP-99), the Commander-in-Chief United States Joint Forces Command is designated Lead Agent for Joint Force Training. His responsibilities include managing the Commander-in-Chiefs' (CINCs') portion of the CJCS exercise program and conducting joint and interoperability training of assigned forces to operate as joint/combined forces. USJFCOM is additionally charged with leading the development and operation of systems and architectures that directly support distributed joint training requirements of other CINCs, JTFs and Defense Agencies. USJFCOM is also designated as Joint Force Integrator. The latter responsibilities include integrating the services and Defense Agencies to enhance interoperability and joint and combined capabilities by recommending changes in doctrine, organization, training and readiness, materiel, leader development, and personnel. USJFCOM will also support development and integration of fully interoperable systems and capabilities, including C4ISR for warfighting; act as Department of Defense executive agent for Joint Warfighting Experimentation; and support joint doctrine through development, assessment, and distribution of joint tactics, techniques, and procedures. U.S. Joint Forces Command has developed the Joint Distributed Learning Center (JDLC) and is using advanced distributed learning technologies and methodologies to supplement existing Joint Training Exercise and Deployable Training Team programs. This accomplishes the joint training mission assigned in the Unified Command Plan and articulated in the Joint Staff's Joint Training Master Plan. The JDLC is a virtual web site that contains the training content and references used in JTF training. The mission of the JDLC is to be a single, comprehensive source of web-based joint training opportunities for JTF and CINC battle staffs in preparation for exercises or real-world operations in accordance with the CINCs' Joint Mission Essential Task List. A fully developed JDLC will enable Joint warfighters to have web-based "reach-back" to the Joint Warfighting Center (JWFC) for desired information--anytime, anywhere, in a "push" or "pull" environment. Currently, the JDLC is deployed on the NIPRNET and SIPRNET and is under continuous development.

U.S. Joint Forces Command will develop content for web-based delivery, accessible to warfighters anytime, anywhere. This content will consist of specific expert subject matter content relevant to Joint Task Force and CINC battle staffs, lessons learned and other pertinent information currently resident in the JWFC. Content will be developed "by operators, for operators" to ensure ease of use and value added to the joint warfighter. Content format will vary from HTML documents to media-rich, interactive courseware incorporating auto-tutor and user profiling technologies. All content development will be certified by active duty military observer-trainers and will be in compliance with CJCSM 3500.03 Joint Training Manual, Appendix D, "Joint Course Development and Management Process." Where appropriate, JDLC content will be submitted for official joint courseware approval via the Joint Staff.

The U.S. Joint Forces Command Joint Warfighting Center's Joint Doctrine Division chairs the Joint Training Curriculum Working Group (JTCWG). This working group has representatives from the combatant commands, services, Joint Staff J-7 (JETD/MED) and National Defense University; other representatives from joint training organizations attend on an as-required basis. The JTCWG coordinates and

prioritizes joint course development requirements and accreditation reviews. Joint courses developed under this process form a joint training courseware base that can be used for joint training whether conducted by resident instructors in academic settings, in the field by combatant command or service instructors, or by instructors from joint training support agencies or organizations.

**2.6 Military Services.** The Military Services carry out training per their Title 10 responsibility. In support of the Department of Defense ADL Implementation Plan the Military Departments are responsible for the following:

**2.6.1 Army.** On 7 August 1999, the Under Secretary of Defense for Personnel and Readiness (DUSD(R)) and the OSD Comptroller tasked the services to provide data identifying programs, schedules, and resources supportive of the Advanced Distributed Learning (ADL) initiative. As a part of this effort the Army has examined its program in detail and provided OSD with objectives, requirements and resources for inclusion in the ADL Implementation Plan. Collectively with the ADL Program, and in collaboration with the services, the Army will work to improve training, enhance force readiness, and support Army transformation by exploiting current and emerging distance learning technologies to develop and deliver quality training and education materials to military personnel anytime, anywhere.

This information was submitted for incorporation in the ADL Implementation Plan in November 1999 and was derived from ongoing implementation actions of The Army Distance Learning Program (TADLP) with ADL content. The Army will improve training, enhance force readiness, and support Army transformation by exploiting current and emerging distance learning technologies to develop and deliver quality training and education materials to all Army personnel anytime, anywhere.

The Army Application. The Army Distance Learning Program, in collaboration with the National Guard Bureau's (NGB) Distributive Training Technology Project (DTTP) and the U.S. Army Reserve's (USAR) Reserve Education and Learning Program (REAL), provides a model for the ADL initiative. These programs deliver standardized individual, collective, and self-development training and educational opportunities to soldiers and civilians anywhere at anytime using multiple means and technologies. Army distance learning blends Active and Reserve Components' training requirements that have the greatest impact on readiness. The long-term goal to train soldiers anywhere at anytime is being achieved through a distance learning (DL) infrastructure of training facilities, communications networks, and DL-enabled courseware that meets the ADL standard for a Sharable Courseware Object Reference Model (SCORM). In implementing its Program, the Army seeks to maintain a balance in effort and expenditure of funds between infrastructure development and courseware preparation.

Responsibilities. The Headquarters Department of the Army (HQDA), Deputy Chief of Staff for Operations and Plans is responsible for resourcing and establishing Army training policy for implementing Army Distance Learning.

The Commanding General, U.S. Army Training and Doctrine Command (CG, TRADOC) is the Army's executive agent for TADLP. Program administration and supervision is provided by a TRADOC Program Integration Office (TPIO) specifically-designated by the CG, TRADOC.

Under the provisions of DoD R5000, the Army DL program was designated as an Acquisition Category I (ACAT I) Program, and the Headquarters, Department of the Army (HQDA) Director of Information Systems for Command, Control, Communications, and Computers (DISC4) was appointed the Milestone Decision Authority (MDA). The TRADOC Product Integration Office (TPIO) TADLP works directly with and provides guidance to an acquisition and fielding Program Manager (PM) designated by the Assistant Secretary of the Army (Research, Development, and Acquisition) as the Army Acquisition Executive.

The Army National Guard (ARNG) and USAR are integral participants in the implementation of distance learning. The Chief, NGB is the executive agent for DTTP. The Chief, Army Reserve is the executive agent for the REAL program.

2.6.2 **Navy.** Changes in mission and operations, as well as advances in weapon systems technology, have significantly increased the performance demands on human operators in today's Navy. To support these challenges, the Navy's education and training programs must change to ensure Navy professionals keep pace with emerging technologies and are prepared to successfully meet critical network-centric information warfare mission requirements.

ADL is a key piece in reengineering naval education and training to facilitate the Navy's Strategic Training mission "*to transfer more knowledge to more sailors in less time and at less cost.*" This mission will allow the Navy to deliver quality education and training—to the right people, anytime, anywhere—as part of a career-long training continuum supporting Navy operational readiness and personal excellence. The Navy's ADL Program is called Navy Learning Network (NLN). The implementation of NLN will be an investment in operational readiness.

The Navy Learning Network mission is three-dimensional: (1) to provide learning environments across time and space, (2) to manage learners and learning to ensure readiness across career continuums, and (3) to provide decision support through data warehousing and decision support tools. The NLN addresses economic considerations as well as learning effectiveness. The system must be economically pragmatic. This will mean leveraging existing architecture facilities where possible, at least in the near term, while preparing to take advantage of the emerging infrastructure and facilities available in the future. This will also mean capitalizing on cost sharing wherever possible. Cost sharing will be achieved, not only through arrangements with other Department of Defense components, but with organizations such as higher education institutions, and business and industry groups.

The Navy College Program is one example of how Navy is already leveraging industry as an initial step to our ADL initiative. This program offers sailors one-stop shopping to determine recommended college credit for Navy training courses and work experience, and to obtain academic counseling and advice to select and enroll in a college program of their choice either ashore or deployed. It allows them to identify career-related education degree programs and focuses on helping sailors to voluntarily obtain a college degree while in the Navy, when they are ready and at their own pace.

The NLN is designed to support reusability and repurposing of learning content using several distributed learning technologies and methods. NLN will be a vehicle to deliver learning products, by interfacing with a multitude of decision support systems, libraries, course catalogs and on-line discussion capabilities. NLN will be a single, integrated Navy architecture to manage inputs, job definitions, profiles, career paths, training and education requirements and opportunities, scheduling, student data management, tracking, and recording. The quality of instruction made available to learners is key to evaluating the success of the NLN. Efforts must focus on proper instructional design methodologies to ensure the system measures the student's progress in meeting learning objectives. The NLN will leverage the efforts of the Department of Defense ADL Initiative.

Investments in this technology will shorten schoolhouse-based pipelines, accommodate changing demographics, make proficiency training readily available Navy-wide, and save temporary duty costs. This means we will get Sailors to the Fleet faster, keep them there longer, and more effectively maintain their levels of skill proficiency.

**2.6.3 USMC.** The United States Marine Corps is aggressively pursuing ADL via the Marine Corps Distance Learning Program (MCDLP). The MCDLP is a fully funded, Total Force program supporting both the active Marine Corps and the Marine Corps Reserve. The MCDLP recently completed a three-year pilot phase and received Milestone III acquisition approval. The program is scheduled for Initial Operational Capability in the 4<sup>th</sup> quarter FY 01. Full Operation Capability (FOC) is scheduled for FY 05. The MCDLP is managed by the Distance Learning Center (DLC) within the Training and Education Division of the Marine Corps Combat Development Command, Quantico, VA.

The Corps' ADL courseware is delivered via a virtual network known as MarineNet. MarineNet consists of a series of base intranets connected to the Marine Corps Institute via the Marine Corps Enterprise Network. At present, MarineNet reaches five bases; but, by final operational capability (FOC), it will offer content to all USMC bases and stations, reserve centers, Marine Detachments, remote learners (via the World Wide Web), and eventually, deployed Marines (via Deployable Learning Resource Centers).

The Marine Corps is dedicated to providing Joint Force Commanders with highly trained and manned units. To ensure this, MarineNet will be interoperable with other services and Department of Defense ADL systems. This interoperability is initially

limited but will increase over time as technical standards mature. The MCDLP is dedicated to adopting open standards and industry best business practices.

With approximately thirteen percent of Marines in the pipeline at any one time, the Marine Corps is committed to shortening the training pipeline while still providing high-quality training. Reduced training time translates into returning Marines to their operational commanders quicker, thus raising USMC readiness. The Marine Corps ADL program will be a key ingredient in this process and is designed to support the modernization of Marine Corps training and education.

**2.6.4 Air Force.** The Air Force conducted a comprehensive review of Air Education and Training Command (AETC) courses, established the Air Force Institute for Advanced Distributed Learning, and assigned responsibilities for developing and implementing ADL. The AF ADL Program is standards-based, and uses government, industry, and academia best practices where standards have not been developed. The following paragraphs describe component ADL roles and responsibilities in the implementation of ADL.

Active Air Force. The Air Force Director of Personnel (HQ USAF/DP), in concert with Air Education and Training Command's (AETC) Director of Education (HQ AETC/ED), establish policy and vision for AF ADL.

- HQ AETC is the lead command for AF ADL, and HQ AETC/ED is the executive agent for Air Force ADL. HQ AETC/ED is responsible for planning, programming, budgeting, and implementing ADL AF-wide (for systems that cut across MAJCOMs), and for planning, programming, budgeting, and implementing ADL at the Air University. The AETC Director of Operations (HQ AETC/DO) is responsible for planning, programming, budgeting, and implementing ADL for technical and flying training in AETC. The AETC Director of Personnel (AETC/DP) is responsible for planning, programming, and manning AETC Education Centers in support of ADL.
- HQ AETC/EDD is: (1) HQ AETC/ED's executive staff for ADL, and (2) Commander, Air Force Institute for Advanced Distributed Learning (AFIADL).
- AFIADL has three key responsibilities in accordance with AFI 36-2201. It:
  - (1) is the focal point for implementation of AF ADL policy and emerging ADL technology;
  - (2) is the executive agent for the AF Extension Course Program; and
  - (3) has operational control of the Air Technology Network (AFIADL/DB).
- The HQ AF Training Division (HQ USAF/DPDT), in concert with the HQ AETC/EDD, executes AF ADL policy, represents the USAF at service/OSD and Joint ADL meetings, and defends budget requests and funding levels. MAJCOMs

are responsible for assigning a MAJCOM ADL POC for implementing ADL policy and developing MAJCOM ADL plans.

Air Force Reserve (AFR). HQ, USAF/REPP together with HQ AFRC/DPT is responsible for the implementation of ADL. Together they:

- (1) represent the Air Force Reserve Command at service/OSD and Joint ADL meetings,
- (2) submit/defend budget requests and funding levels, and
- (3) establish ADL policy and procedures as needed to support Air Force Reserve Command (AFRC) unique mission requirements.

Air National Guard (ANG). The ANG receives education and training from AETC to satisfy its federal mission responsibilities in accordance with Air Force standards and requirements. ANG personnel must also receive education and training to satisfy state mission requirements. The ANG ADL Program, through Warrior Network, links to all other service, Joint and Department of Defense agency ADL programs. ANG/DPT provides MAJCOM-level support of the AETC training program as well as state mission training requirements.

**2.7 National Guard Bureau.** The National Guard is joined together with counterparts in the active Army and Air Force to train our soldiers and air warriors in our federal missions. We are collaborating broadly and deeply to maximize the readiness of the total force. We also continue to develop and coordinate Guard-specific training resources, information systems, and communications technology resources of the NGB, the Army National Guard (ARNG), and the Air National Guard (ANG) to meet learning (and command, control, computer, and communications) requirements for the Guard's federal and state missions, and for congressionally-mandated responsibilities.

The Guard is an active supporter of the Department of Defense ADL initiative and will expand its collaboration with the Department of Defense ADL community. The Guard, as a pioneer in enterprise-wide DL, has also developed a capability to share lessons learned in developing and implementing strategies in the areas of technology systems; learning support systems to include courseware development; leadership and culture to include championship and guidance; and business processes to include e-business, knowledge management, and e-commerce solutions. The Guard will also expand its partnership with the ADL team as a sponsor of the "ADL Co-Lab" by facilitating ADL prototypes, leveraging GuardNet XXI, and the installation of a Distributive Training Technology Program (DTTP) classroom at the ADL Co-Lab.

The National Guard is also engaging commanders and stakeholders in developing goals, objectives, and strategies for the implementation of DL at all levels of the Guard's federal and state organizational structure. The message of DL's demonstrated and potential return on investment is also transmitted by the state Adjutants General and at conferences of the Guard's functional communities.

The combination of strategic championship by the NGB, ARNG, and ANG leadership; establishment and enhancement of GuardNet XXI, Warrior Net, and the DTTP;



empowerment of the National Guard Bureau Army Training Division DL Branch (NGB-ART-D) and the Air National Guard Personnel Force Development Division (ANG DPD); rapid prototyping by the National Guard's Professional Education Center (PEC) and the Training and Education Center (TEC), and other Guard regional and functional training resources; and the pioneering application of DL by state Guard organizations and by shared usage partners has resulted in a growing return on investment and implementation of congressional intent.

The NGB Program Executive Office for Information Services (PEO IS), the NGB DTTP, the ARNG Training Division (NGB-ART), the ANG Personnel Force Development Division (DPD), the ARNG Professional Education Center (PEC), the ANG Training and Education Center (TEC), and the Military Interactive Multimedia Instruction Center (MIMIC) are supporting ADL by creating models and frameworks for collaboration in many DL areas. As a multi-component force, these Guard elements are proving concepts that can serve as benchmarks for technology, business processes, learning support collaborations, courseware development/conversion, and for the department.

**2.8 Coast Guard.** The genesis of the Coast Guard's Advanced Distributed Learning Plan (CGADLP) is the Chief of Staff's FY 2000 Determinations, which directed the development of a comprehensive plan taking full advantage of new technologies and new human performance improvement methodologies, and integrating Coast Guard training.

The CGADLP is based on Department of Defense initiatives and is designed to establish a "learner centric" system employing emerging network-based technologies and to be revalidated and updated as new technology becomes available. It will deliver efficient and effective high-quality tools, instruction, assistance, and performance support to Coast Guard personnel anytime, anywhere. The CGADLP will also help alleviate Operational Commanders readiness concerns over the loss of personnel to away from home station training and alternatively, to loss of mission time through the unit's acceptance of the training burden. These concerns demand that the Coast Guard re-engineer the education and training system taking advantage of information-age technology.

The Coast Guard identified several proven technologies which fit within funding, automation and personnel constraints that will continue to evolve over time.

They are:

1. Electronic Performance Support Systems and Technical Manuals,
2. Interactive Courseware/Computer Based Training (ICW/IBT),
3. Interactive Video Tele-Training (IVT), and
4. Web Based Delivery.

The Coast Guard will employ technologies to improve workforce performance and continue developing its capability to deliver synchronous web-based training. Commercial tools currently under test and development by the Performance Technology

Center enable instructors from resident environments to quickly review their lesson plans, materials and media for delivery via the web. Live, web-based modules use a multi-media approach and costs are minimal. The curriculum is close to the classroom environment in scope and duration and can be stored for later use in an asynchronous environment. Long-range goals are to fully implement CGADLP supporting a full-range of operational learning needs and increasing readiness. Assessments of ADL prototypes will be aligned to collaborate with Department of Defense ADL initiatives to enhance effectiveness, efficiency and eliminate duplication.

### **3.0 Implementing Common Specifications**

“People often take the view that standardization is the enemy of creativity. But I think that standards help make creativity possible -- by allowing for the establishment of an infrastructure, which then leads to enormous entrepreneurialism, creativity, and competitiveness.”

Vinton Cerf  
Senior Vice President for Internet Architecture  
MCI WorldCom, Inc.

### **3.1 The Sharable Courseware Object Reference Model (SCORM) Background**

The Department of Defense, in response to mandates from the President in Executive Order 13111, worked collaboratively with other government agencies, academia and private industry to develop a common specification for instructional software. This specification ensures interoperability and reuse across federal agencies. In response to direction from the Secretary and Deputy Secretary of Defense to develop a strategy and plans for implementing learning technologies on a broad scale across the department, the Under Secretary of Defense for Personnel and Readiness released the department’s common specification for ADL on January 31, 2000.

The Under Secretary of Defense for Personnel and Readiness stated that this specification provides the foundation for how the Department of Defense and others will use learning and communications technologies to build and operate in the learning environments of the future.

Many commercial vendors, like Microsoft, IBM, click2learn, Macromedia, and others, including international standards bodies such as the Instructional Management System Global Learning Consortium (IMS), the Aviation Industry CBT Committee (AICC), and the Institute of Electrical and Electronics Engineers (IEEE), have provided positive statements supporting the specification’s release, as have academic partners from the University of Wisconsin System, the Wisconsin Technical System, and Carnegie Mellon University.

In response to the tasking contained in Executive Order 13111, the department provided a final report, entitled “Establishing a Federal Framework for Distributed Learning” to the Presidential Task Force on Federal Training Technology in March 2000. In addition to

making the SCORM specification available to other federal agencies, this report encouraged the federal agencies to participate in collaborative development efforts through the newly formed ADL Co- Laboratory in Alexandria, Virginia.

### 3.2 The Technical Working Group (TWG)

The primary agent in addressing the critical area of standards generation has been the ADL Technical Working Group (TWG). This collaborative group is comprised of members of the Department of Defense with representatives from industry, academia, other federal agencies and all the major standards-granting organizations. The TWG's work has been focused on the creation of the Sharable Courseware Object Reference Model—SCORM. Sharable courseware objects have been defined as those portions of a course which are packaged with sufficient information to be reusable, accessible, interoperable and durable. When combined with the reference model, the result is a map which defines the interrelationship of course components, data models, and protocols such that courseware "objects" are sharable across systems that conform to the same model. The ADL SCORM initiative is intended to work as a catalyst among industry and user communities to accelerate the development of needed specifications that meet Department of Defense/federal requirements for interoperability, reuse, accessibility, and durability of web-based learning technologies.

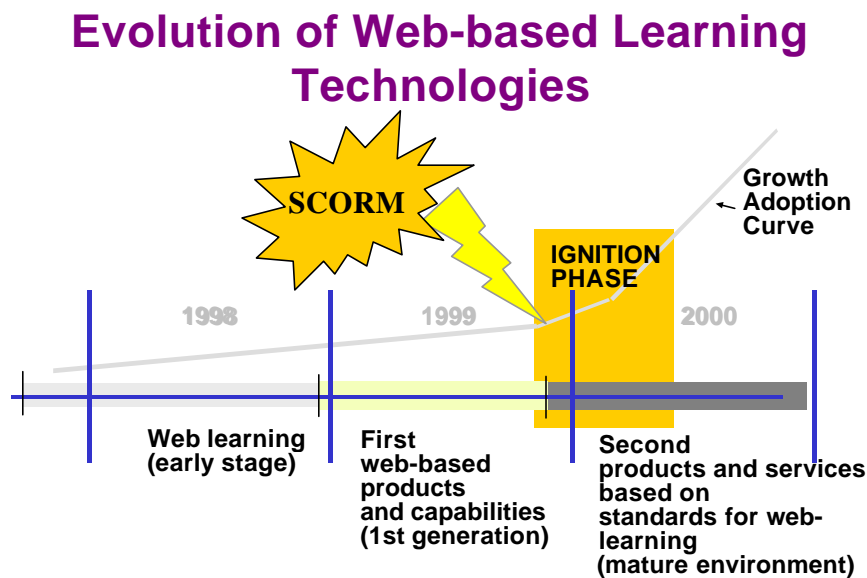

**Figure 2.** Evolution of Web-based Learning Technologies

ADL has collaborated with members of the Instructional Management System (IMS), Aviation Industry CBT Committee (AICC), and Institute of Electrical and Electronic Engineers (IEEE) on various parts of the SCORM, and has determined that significant components of the ADL SCORM can—and should—be synchronized with the work of these groups. While the ADL SCORM defines a very specific so-called "content model," it appears that work from other standards groups can be integrated into this model and

adapted or extended to meet ADL requirements. The goal of the first version of the ADL SCORM is focused on web-based learning content and is intended to enable the following:

- The ability for a web-based Learning Management System (LMS) to launch content authored using tools from different vendors and to exchange data with that content.
- The ability for web-based LMS products from different vendors to launch the same executable contents and exchange data with that content during execution.
- The ability for multiple web-based LMS products/environments to access a common repository of executable content and to launch such content.
- The ability to move an entire course from one LMS to another (course interchange).

### **3.3 Sharable Courseware Object Reference Model Status**

The release of this document completes the initial drafting and review of early-stage web-based learning specifications. The ADL Initiative, in parallel with the testing phase, which is expected to take four-to-six months (May-July 2000), plans to release example implementations, addenda to this document, and at the end of the phase, a suite of conformance-test software. These products will permit content and tool developers to verify that their work products conform to the SCORM specification and are reusable, interoperable, accessible, and durable.

*See Appendix 3 for additional detail. The full documentation and its associated software development kit are available for review or download at <http://www.adlnet.org>*

### **3.4 Setting and Implementing Courseware Standards**

In order to keep courseware conversion, development, and sustainment costs in line with budgets, Department of Defense components must develop courseware modules that can be used and reused department-wide. It is imperative that courseware and content authoring tools adhere to a standard that makes all courseware reusable by various delivery systems. Department of Defense has participated in joint negotiations with academia, industry, other government agencies and with the standards-granting bodies to arrive at common specifications for recognizing and accessing courses, lessons, modules and other files housing useful building blocks of instruction. The ADL “standards” effort built consensus among users, developers and industry. It served as a catalyst to bring together key players and forge alliances in strategic technical areas. The participants have agreed to a set of initial specifications, called the SCORM Version 1.0 that is incorporated in this Plan. The joint community and the military departments have voluntarily agreed to use and test the SCORM in development of content. Following its release the specification work has entered a trial and implementation phase. Over the next six months the SCORM will become more robust, and Version 2.0 will be released. It is expected that commercial-off-the-shelf (COTS) products and services will be available in the later part of this year.

If this schedule holds firm then the Department of Defense components should comply fully in December 2001 when the specification is adopted as a standard.

The initial SCORM specification is provided at Appendix 3. A standard for Learning Management Systems is in work as an extension of the basic SCORM. It also builds on the results of international standards groups' deliberations.

### **3.5 ADL Co-Laboratory**

The Department of Defense established the ADL Co-Laboratory in 1999 at the Institute for Defense Analysis (IDA) to foster the collaborative research, development, and assessment of the common tools, standards, content, and guidelines for the Advanced Distributed Learning Initiative. Executive Order 13111, tasked the Department of Defense to take the lead in working with other federal agencies and the private sector to develop common specifications and standards for technology-based learning that could be used to support federal and national education and training needs. The Department of Defense was also tasked to provide guidance to other federal agencies on the best use of these specifications and standards. As the focal point for the new SCORM specification, the ADL Co-Lab will provide a forum and technical support for developing and assessing prototype tools and content (see Figure 3) that adhere to the new evolving specification.

The Department of Labor has joined the ADL Co-Lab as a "contributing sponsor" and is integrating the Federal Learning eXchange (FLX) and the Federal Learning Technology Resource Center (FLTRC) into Co-Lab operations. The FLX will provide a "yellow pages" listing of training and education for federal employees and will foster communications between public and private-sector organizations to identify and meet common needs. The FLTRC will address the need to support federal agencies using training technology and to facilitate the development of on-line training courses. These capabilities, combined with the ongoing ADL development efforts, will link job openings with the on-line learning resources, giving workers greater access, flexibility, and control of their career development.

ADL Co-Lab nodes have been established in Orlando, FL, and Madison, WI. The Joint Orlando Co-Lab node was established to promote collaborative development of ADL prototypes and ADL systems acquisitions, principally among Department of Defense components. In January 2000, an independent academic Co-Lab was established in partnership with the University of Wisconsin and the Wisconsin Technical College System to promote collaborative development, demonstration, and evaluation of next-generation learning technologies that enable distributed learning, principally among academic institutions. All three Co-Laboratories work together to share research, subject-matter expertise, common tools and course content through a virtual ADL Co-Lab network.

In January 2000, the Joint Co-Lab issued a "focus call" for ADL prototype proposals. A significant number of proposals were received from education and training developers across the Department of Defense. Incentive funds were awarded for those proposals in April 2000 that placed the greatest emphasis upon collaboration and adherence to the new

SCORM specification. ADL prototype developers will demonstrate the interoperability and reuse of their ADL course modules at a number of “plugfests” or interoperability demonstrations to be hosted by the ADL Co-Labs throughout the year.

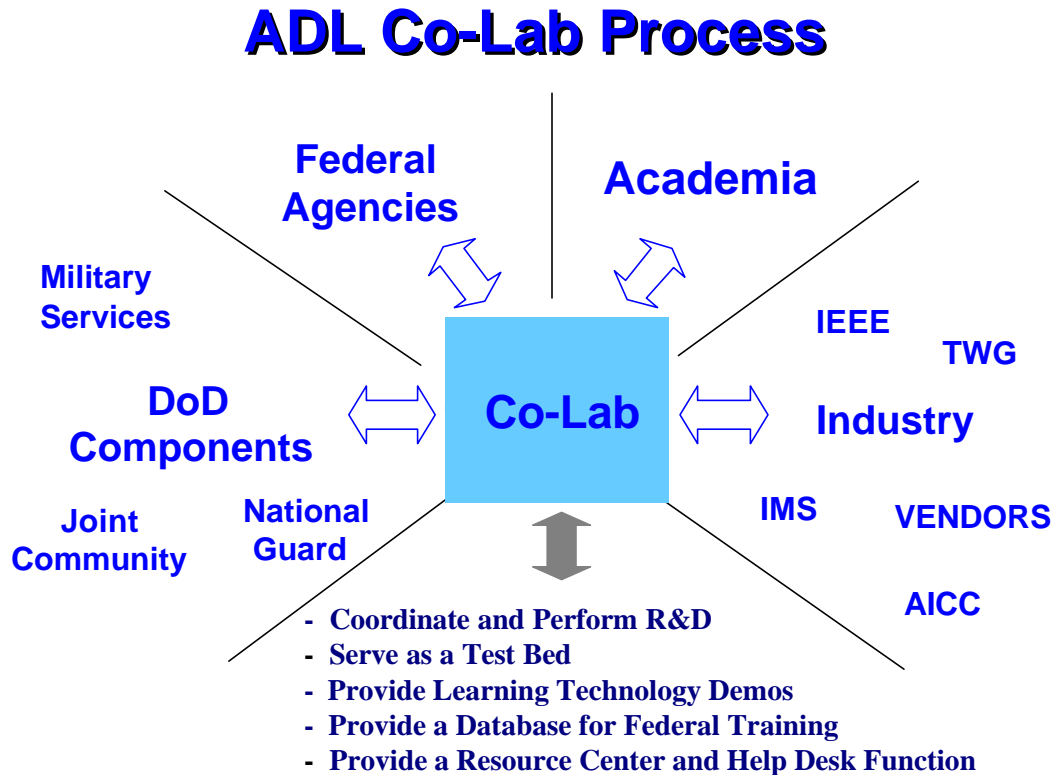

**Figure 3.** ADL Co-Lab Concept of Operations

**3.5.1 Coordinate and Perform Research and Development.** Many studies performed over the last 40 years have demonstrated the potential and promise of technology for improving instruction. In both education and training, technology has been shown to significantly increase achievement and effectiveness while lowering costs. For example, some uses of learning technology have demonstrated a one-standard-deviation (one-sigma) improvement in student performance – that’s the equivalent of a full letter grade improvement. Some leading researchers believe that a two-sigma shift in student performance is within reach. The potential to quickly increase the “average” student’s capabilities and performance to the 98th percentile level (a two-sigma shift) would provide enormous benefits to society and to national competitiveness. But the speed of technological change, coupled with the proliferation of proprietary systems, has made it very difficult to successfully implement learning technologies on a large-scale or to leverage the resources and investments of others. The development of common specifications and standards for interoperability, accessibility, and reuse (i.e., the SCORM) establishes the foundation for a common distributed learning environment that can sustain the needs of a nation of life-long learners.

Having shown that instructional technology works, we must now learn how it works. Many of the federal agencies are pursuing research and development on the instructional uses of technology. However, more will be accomplished if their efforts can be integrated and coordinated - the whole is greater than the sum of the separate contributions. The ADL Co-Lab will serve as a virtual and common resource to coordinate and leverage the learning technology research and development across the Department of Defense and the federal agencies, and in some cases, in cooperation with academia and the private sector.

The ADL Co-Lab will help determine how learning technologies can be designed to bring about specific, targeted instructional outcomes reliably, within as wide a range of instructional settings as possible. Other research areas include determining the most effective methods to:

- Tailor pace, content, sequence, and style of instruction to the needs of individual learners -- taking advantage of their strengths and concentrating on areas where they need help;
- Integrate technology within our existing instructional institutions and determine what changes are needed for these institutions to maximize return on investments in technology;
- Develop new instructional techniques, such as intelligent tutoring, tutorial simulations, and networked simulation, that take full advantage of the capabilities technology brings to instruction;
- Assess the costs and effectiveness of instructional programs; and
- Measure and verify the capabilities and performance of learners.

**3.5.2 Serve as a Test Bed.** The Co-Lab also will provide an open environment for testing and evaluating learning technologies and content associated with distributed learning. It will foster the development, dissemination, and maintenance of guidelines to support Department of Defense and other federal agencies. These guidelines will include use of instructional development tools, design and development strategies, and evaluation techniques. As such, the ADL Co-Lab will facilitate resource sharing across the federal agencies and the private sectors.

The testing and evaluation performed by the Co-Lab will be based on a family of common specifications and standards, such as the SCORM. These specifications and standards will be coordinated and integrated across the various standards bodies, as well as between the public and the private sector. The ADL Co-Lab will test and evaluate projects in order to determine whether they meet user requirements for reusability, accessibility, durability, interoperability, and cost-effectiveness. Candidate projects for the ADL Co-Lab are those that:

- Demonstrate the ability to move web-based courses from one learning environment (learning management system) to another;

- Demonstrate the reuse of learning content "objects" across different platforms and learning environments;
- Provide searchable learning content across different learning environments or media repositories;
- Provide adaptable learning tools and content that can be tailored to the needs of the individual learner on the fly; and
- Support intelligent systems and intelligent tutoring capabilities

**3.5.3 Provide Learning Technology Demonstrations.** The ADL Co-Lab is soliciting federal, academia, and private-sector participation in a series of “plugfest” events, to be conducted quarterly throughout the remainder of the year, to demonstrate the interoperability and reuse capability of ADL prototypes and to refine and update the SCORM. Invitations and criteria for participation will be posted on the Advanced Distributed Learning Network (<http://www.adlnet.org>). The Co-Lab will serve as a hands-on showcase for ADL demonstrations and products. It will also function as a clearinghouse for distributed learning technologies, prototypes, and projects. Virtual demonstrations and “web-casts” over the Internet will allow for the widest possible dissemination.

The ADL Co-Lab will provide a repository of distributed learning resources. This repository will include learning content "objects," simulations, and interoperable learning management systems. The repository will be hosted on a distributed system of resource servers, interconnected through the World-Wide Web.

**3.5.4 Provide a Database for Federal Training and Resource Center.** As a major sponsor and participant in the ADL Co-Lab, the Department of Labor will oversee the development and implementation of the Federal Learning eXchange (FLX). FLX will provide an on-line repository of federal training resources and a marketplace to foster collaborative development of training among federal agencies. Included in the listing will be courses developed and offered, to federal employees and selected segments of the public, by federal departments and agencies. Courses that are available to selected segments of the public will be shared with FLX's parent database, America's Learning eXchange (ALX). ALX is the national “yellow pages” of training created by the Department of Labor.

FLX will provide a secure web environment that will enable departments and agencies to collaborate and seek partnerships in the development and use of learning technology, communicate needs, and share resources and services. The FLX marketplace will also provide departments and agencies with access to software providers who offer trial and pilot test opportunities for their products. This will allow ready, free access to information for federal organizations about learning software and software tools.



The FLX will leverage the tools, specifications, and learning content developed under the ADL Initiative and ensure these materials are made available throughout the federal sector.

**3.5.5 Provide a Resource Center and Help Desk Function.** The support personnel and information resources of the Federal Learning Technology Resource Center (FLTRC) will be hosted at the ADL Co-Laboratory. The FLTRC will deliver its services through an interactive web site, live demonstrations and other on-site services. The Center's web site will support on-line moderated and open discussion groups, technology list-serve portals, relevant procurement information for users and providers, and information and tracking services for standards development and implementation.

Other FLTRC web services will include a site for departments and agencies to showcase learning technology efforts, news service, interactive events for the federal technology learning community, a contact list of federal technology leaders, volunteer mentors, a directory of presentations on federal learning technology, and a listing of exemplary models. The site will also host pro-active user feedback access and a dynamic Frequently Asked Questions (FAQ) service.

### **3.6 Examples of Recent Joint ADL Prototypes**

**3.6.1 Joint Doctrine Training Model.** The Joint Staff developed ADL Initiative Prototypes that provide joint doctrine education and training via the Internet and CD-ROM. The objective is to provide high-quality joint doctrine to the Total Force – *anytime, anywhere*. Military personnel in Bosnia have used one prototype in order to gain an understanding of Joint Task Force operations. Additional modules are currently under development, including a Crisis Action Planning Course that uses web-based intelligent tutor technology to train staffs in Joint Task Force (JTF) Operations.

**3.6.2 Joint Electronic Library.** The Joint Staff has developed a Joint Electronic Library (JEL) which can be accessed through the Internet and will be available on the Joint ADL Network. The JEL contains over 10,000 digital files, including all joint doctrine publications, CJCS Instructions, key service publications, and a host of other reference documents. The JEL web site is among the most popular and often-used joint sites in the Department of Defense, averaging approximately 200,000 accesses per week.

**3.6.3 Joint Doctrine Electronic Information System (JDEIS).** The next evolution of the JEL is the JDEIS, which is currently under development. The JDEIS is envisioned as an organized multimedia interactive information system containing a database of doctrine, which is linked electronically to the Universal Joint Task List, selected CJCS instructions and manuals, lessons learned, historical collections, future concepts, the Department of Defense dictionary, and other related doctrinal materials and references, such as JFCOM's JDLS and NDU's JVLE. It will also include a sizable amount of complementary research, audio, video, and other multimedia material. JDEIS will be rapidly accessible by the entire military community from the Internet and the Joint ADL

Network. The JDEIS is intended to be a joint doctrinal information and awareness tool to provide information to members of all services and to other government agencies. The central core of JDEIS will be the joint doctrine database to which all other system materials will be linked. The JDEIS is intended to have attributes that will improve our ability to organize, locate, and reference joint doctrine. Its overall goal is to provide the members of the joint community rapid, ready access to doctrinal information required for the myriad operational tasks they face.

**3.6.4 Doctrine Networked Education and Training (DOCNET).** The Joint Staff recently put the DOCNET System into initial operation. This on-line service consists of interactive multimedia presentations of key joint doctrine concepts. The content for each module is drawn directly from doctrine without interpretation and is, therefore, an authoritative information source for use by the U.S. Armed Forces. The goal of DOCNET is to “bring joint doctrine to life” by presenting the information in a convenient format, employing varied instructional techniques, and taking advantage of the latest interactive multimedia technologies. The Internet-based system will initially include approximately 32 modules of instruction on joint issues related to joint doctrine.

DOCNET modules are currently accessible worldwide, seven days per week, 24 hours per day (*anytime, anywhere*), and include interactive animation, case studies, video supplements, and examinations. The modules will be compatible with and available on the Joint ADL Network. The modules are accessible from a password-protected section of the Joint Doctrine web site ([www.dtic.mil/doctrine](http://www.dtic.mil/doctrine)). Seven modules are currently available:

- *Operational Art,*
- *Joint Force Employment Considerations,*
- *Military Operations Other Than War,*
- *Joint Task Force from the Commander’s Perspective,*
- *Joint Fire Support,*
- *Planning Joint Operations, and*
- *Unified Action Armed Forces.*

Three additional modules are scheduled for completion by the end of April 2000. The DOCNET system is designed to enhance the joint doctrine learning experience through on-line modules providing doctrine-based information in an interactive and multimedia environment.

**3.6.5 Crisis Action Planning Tutored On-line Resource (CAPTOR).** As part of its efforts to develop distributed learning courseware, the Joint Staff is also supporting OSD-sponsored ADL Initiative research efforts to develop course content that is Internet-based, is interoperable, and employs the latest developments in cognitive science. Specifically, Air Force Research Laboratory (AFRL), in partnership with the Joint Vision and Doctrine Division, is developing a new intelligent computer-managed course of instruction on Crisis Action Planning for use by the Joint Staff as part of the DOCNET program. The project, entitled CAPTOR, will serve as a prototype test-bed

that meets joint warfighting requirements. The course content will be drawn directly from approved joint doctrine and other official publications and, as such, will be authoritative in nature.

- 3.6.6 Joint Force Employment Interactive CD-ROM Wargame.** To enhance learning of joint doctrine with practical experience, the Joint Vision and Doctrine Division is developing a Joint Force Employment Interactive CD-ROM wargame that leverages leading-edge technologies employed by the video gaming industry. This intelligent, interactive, CD ROM-based simulation will enable users to test their knowledge of joint doctrine and actually conduct a “virtual” joint operation employing doctrinal principles learned from DOCNET. This realistic training tool incorporates a number of different basic scenarios that span the entire range of joint military operations. The simulation includes a “tuner” to modify the numbers and types of forces so that an unlimited number of operational conditions can be created. Delivery of this product to CINCs and services will be in April 2000.
- 3.6.7 Joint Doctrine Operations Laboratory (JDOL).** The future generation of the wargame is the JDOL which is an Internet-based, cooperative, interactive, multi-player, opposing-force simulator designed to facilitate operational exercises, experimentation, and rehearsals in myriad environments and situations. Key leaders and their subordinates will be able to access the JDOL using the Joint ADL Network and participate in focused operations regardless of their locations throughout the world. The JDOL will include both a tuner and an editor, enabling users not only to modify the forces and increase the OPTEMPO, but also to change the physical location and terrain of the operation using realistic maps and intelligence input.
- 3.6.8 Joint Virtual Learning Environment (JVLE).** The National Defense University (NDU) and the Joint Staff are exploring prototype development of an education architecture which integrates all joint and Service Professional Military Education (PME) institutions (e.g., National Defense University, Army War College, and Air Command and Staff College, etc.). JVLE extends the power of knowledge from a campus to the operational commander (Figure 4). The JVLE will provide a capability to push information to and pull information from PME sources, push operational simulations to the PME institutions for near-real time student/faculty analysis, meet operational reach-back needs, and support continuous updating of PME instruction.

## JVLE Implementation Scenarios

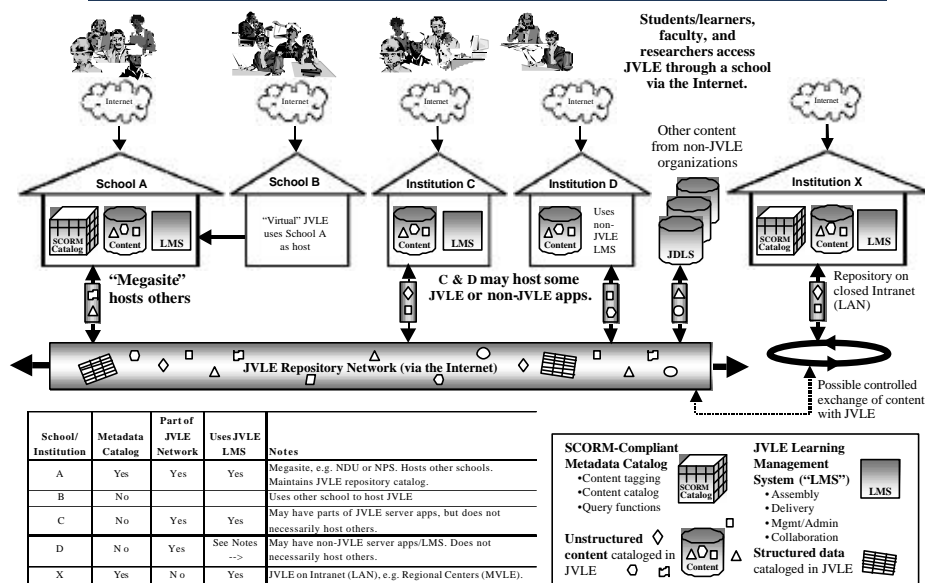

**Figure 4.** Joint Virtual Learning Environment (JVLE) Implementation Scenarios

**3.6.9 Future Joint Training System (FJTS).** The FJTS will be an integrated and synchronized training effort. It will support the National Command Authority (NCA), combatant commanders, combat support agencies and our interagency and multinational partners by harnessing our military power to that of our interagency and multinational partners. It will create a trained and ready combined/joint force that can achieve Full Spectrum Dominance across the range of military operations. The uncertainties of the future requires that training will be more web-based and network-centric than ever before and will lead to a more integrated effort between Department of Defense and non-Department of Defense members of our government and non-federal organizations supporting such varied missions during which the U.S. Armed Forces would be a supporting role. The FJTS will provide state-of-the-art distributed and interactive training for military and interagency organizations via the Joint ADL Network (see 3.8 below). Much of the effort to create this future joint training system will come from the U.S. Joint Forces Command whose Unified Command Plan 99 (UCP 99) designation as lead agent for joint training charges them with standard-bearer duties for joint training.

### 3.7 Regional Centers Global Distributed Learning Data Services Network

The Assistant Secretary of Defense for International Security Policy chartered a Joint Staff-conducted process review with regional combatant commands to examine the possibility of establishing a global distributed learning data services network. The requirements assessment team was comprised of representatives of OUSD (P&R), the Joint Staff, the United States Joint Forces Command, Central Command, European

Command, Pacific Command and the Southern Command. It was successful in furthering the dialogue among principal stakeholders in defining and clarifying implementation issues. In his report to regional CINCs and OSD, the Director of the Joint Staff (DJS) proposed developing a coherent management plan that consolidates currently fragmented authority and clearly identifies respective responsibilities. The DJS has recommended that the policy goals are clearly articulated and programmatic authority is delegated by September 2000. This will take place as part of a long-term development process; one closely aligned with the department's ADL Initiative managed by USD (P&R). The DJS favors establishing a single agency as the resource provider in support of regional CINC-generated demands and for supporting further information sharing between CINCs, with Joint Forces Command acting as the information broker and requirements consolidator.

### **3.8 Joint ADL Network Architecture**

In July 1998, the Joint Staff, based on the successful development of distributed joint doctrine and joint training initiatives, tasked the then-U.S. Atlantic Command to craft a Distributed Joint Training Architecture, now known as the Joint Advanced Distributed Learning Network (JADLN), that could be used anytime, anywhere to pull joint training materials and programs. Concurrently, but independently, the Military Education Coordination Conference (MECC) chartered a working group, the Joint Virtual Learning Environment (JVLE), to find an architecture for enabling Professional Military Education institutions and deployed personnel to query the data resident in the Professional Military Schools' libraries, lectures, exercises, and research files in order to rapidly assemble data deemed necessary to conduct joint training.

As a result of collaboration and detailed coordination, significant progress has been made in both programs. Such progress has allowed preliminary steps to be taken by the Director of the Joint Staff to unite these efforts under the Joint Forces Command, with NDU participation, to explore the creation of a Joint Advanced Distributed Learning Network (JADLN) portal for Department of Defense learning.

# The Joint ADL Network Model

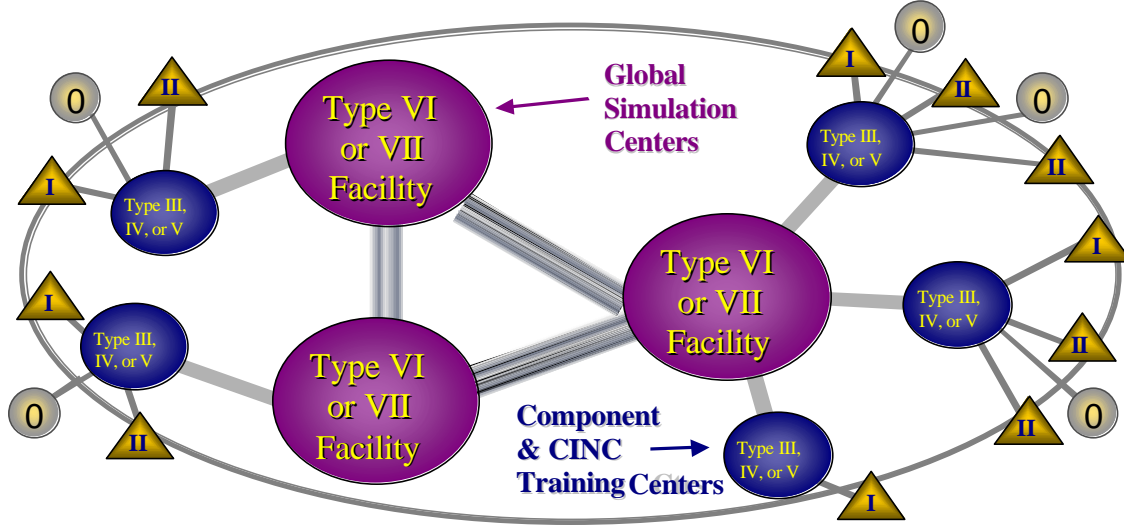

Legend: Training Site Types

<b>0</b> Individual Learner	<b>IV</b> Response Cell
<b>I</b> Interactive Classroom	<b>V</b> Service Training and Simulation Facility
<b>II</b> Operational / Team Training Facility	<b>VI</b> Joint / Service Training / JPME Facility
<b>III</b> Service Training / PME Facility	<b>VII</b> Joint Training and Simulation Facility

Figure 5. Joint ADL Network Model

## 4.0 Implementing Advanced Distributed Learning

### 4.1 Task One - Identifying Requirements and Resources

4.1.1 **Readiness.** Military readiness today is adversely impacted by the OPTEMPO/PERSTEMPO, the broad variety of missions, and the many complex weapons systems in use or being introduced into the armed forces. The Secretary's stated vision of "anywhere, anytime" learning using advanced learning technologies represents a reasonable approach to many of Department of Defense's learning challenges.

*OPTEMPO/Readiness will require that job-related learning and knowledge acquisition become part of a normal duty day. For JPME 2010 to achieve its utmost success, distributed learning cannot be viewed as an "other duties as assigned" activity. It is not enough to make distributed learning material available, it must be given the same priority as that for established readiness indicators, because in the final analysis a ready force is a trained force. Distributed learning must be provided command emphasis and support as an active, on-going requirement. It must be integrated into the tempo of operations (OPTEMPO).*

**4.1.2 Program Review.** In a Program Decision Memorandum, dated August 16, 1999, the Deputy Secretary of Defense directed USD (P&R), in coordination with the Military Departments and the Joint Staff, to review requirements for advanced distributed learning systems, and develop a proposal to implement such systems at minimal cost, while satisfying Joint Vision 2010 and interoperability goals. In connection with this review, the components were tasked to provide OUSD (P&R), by October 15, 1999, detailed reports of their plans, programs and resources that supported the ADL Initiative and other distance learning programs. Based on these reports, the USD (P&R) was tasked to provide a preliminary assessment, together with his findings on near-term funding requirements, to the Deputy Secretary of Defense by November 1, 1999.

The assessment recommended that efforts to define and refine data continue so that policy oversight of the ADL Initiative and associated investments is visible to the leadership of the Department of Defense and its components. The department is exploring the creation of one or more Program Elements for Distributed Learning Systems Development to achieve more effective management of OSD and joint applications of distributed learning technologies and content. The Air Force, through a unilateral initiative, created new ADL program elements for its active, reserve, and guard forces, and the Army has existing program elements through which ADL program resources are managed. Other components are encouraged to create or establish program elements to capture program data on their related ADL initiatives.

On August 6, 1999 the Under Secretary for Personnel and Readiness and the Department Comptroller, as part of the Program Review, jointly issued a call for data for use in documenting existing and planned investments (Appendix 1). This initial data call was a challenge for the components, in that the department was transforming complex business practices developed to support programmatic planning for the future learning environment. However, this effort was useful in gathering distributed/distance learning historical data and in providing trends of how the components were updating and reengineering prior programs and plans and projecting required future investments. In keeping with this data requirement the Committee, supported by the JSCAT, will review the department's progress in the development of ADL-compliant course content.

The components were also tasked to provide the Committee reports on the resources required to sustain their distributed and advanced distributed learning programs, as well as the resources required to convert courses to the ADL SCORM-based compliance. A summary of the initial component reports is provided at Appendix 1.

**4.1.3 Data Assessments.** The ADL initiatives being pursued by the Department of Defense can be generally categorized as relating to infrastructure, user interface, and content. While each is being developed independently, the Implementation Plan addresses the eventual integration of a total package that includes all three. The infrastructure architecture is being investigated in terms of the Joint Advanced Distributed Learning Network. This network architecture describes the communications protocols and standards needed to deliver ADL products, and it will also describe the standards for data management that will enable content developers to ensure their products can be delivered

to all required users. Learning courseware content must be developed to these standards and specifications to ensure proper delivery and usability. The heart of the ADL program will be the content that will be delivered to personnel whenever they need it, wherever they have access. The ADL Implementation Plan provides a complete set of actions that are being initiated to achieve a robust ADL program within the next ten years. It assures integration of various ADL programs being pursued and should bring cost efficiencies to program efforts.

#### 4.1.3.1 Army. Course Content Requirements and Resources.

The R&D efforts have opened many doors and paved the way for the Army DL course content development effort since 1991. R&D has provided the Army with the insights required to develop distance learning training that ensures the *proper balance between content distribution and educational sufficiency*. The heart of distance learning is the efficacy of the training content that will be provided to soldiers anywhere, anytime. This effort includes:

a. To facilitate distance learning content development, the Army invested approximately \$50.0M (FY 1997-1998) in the basic redesign of formal Army training courses to Total Army Training System (TATS) courseware format. This action provides standardized current courseware for all components and establishes a pool of courses ready for redesign for distance learning. The TATS redesign cost and the cost of redesigning courses for distance learning approximates the costs of infrastructure upgrades and development.

b. Redesigning the content of approximately 30% of the Army courses (over 500 courses) for delivery through multiple technologies. Courses are selected for DL based on three principal factors: (1) Improve Force Readiness (2) The content is suitable for distance learning media and (3) There is a potential return on investment (e.g. increased student throughput, or reduced course overhead and per diem costs.)

c. The Army is programmed to redesign course content for distance learning at the rate of 31 courses per year through FY 2002 and 47 per year through FY 2010.

d. Course content will be designed for delivery via multiple means such as Internet, Internet-enabled compact disk (CD), or a hybrid mix of CD and Internet. Internet-enabled CD offers soldiers the flexibility to access the Internet, if available, or to receive quality training directly from an interactive CD. The current Army Program Objective Memorandum (POM) includes \$152.8M to fund the redesign of course contents.

#### DL Infrastructure Requirements.



a. The Army is moving to web-based training to meet the ADL requirement to deliver training anywhere at anytime; however, the need to deliver training through Digital Training Facilities (DTF), as established in the April 1996 Army Distance Learning Plan, is still critical during the early stages of the Program. At this stage, DTFs offer several advantages:

- (1) Security risks and access vulnerabilities associated with crossing the “*dot com*” and “*dot mil*” domains are avoided.
- (2) Soldiers will have the capability to freely access Army training materials from locations that have a C2 security level.
- (3) Efficiencies will be gained by establishing integrated network systems and centralized work stations rather than upgrading or installing necessary communications wiring in every soldier’s quarters and duty location.
- (4) Provides standard equipment and software that ensure its compatibility with reusable course content.
- (5) Ensures effective learning management, i.e., student, lesson, and course management.
- (6) Helps meet the Army’s goal to provide access to DL training resources within 50 miles of 95% of the Army population, which includes all components.
- (7) Supports students, who do not have personal automation equipment and are new to distance learning training, 24 hours per day, 7 days per week.

b. A recent analysis of TADLP by a TPIO working group recognized the transition to integrated network systems. Accordingly, the working group recommended reducing the AC requirement for DTFs in CONUS by thirty percent. As technology improves, the Army will periodically address facility requirements.

c. The ADL initiative seeks a balanced funding ratio between course content and infrastructure development. Army investments over the past three years have resulted in a ratio of 40% courseware to 60% infrastructure investment. This equates to a \$203M investment in content with the remainder of the funding, \$356M, supporting acquisition, operations, sustainment, and enterprise management for course content and infrastructure. Investment in course content redesign will continue to grow following the initial infrastructure investment.

Key TADLP requirements are to:

- (1) Enhance force readiness.
- (2) Train to standard.
- (3) Exploit technology.
- (4) Accelerate courseware redesign.
- (5) Demonstrate return on investment.
- (6) Change cultural paradigms.
- (7) Incorporate training requirements in support of Army transformation.
- (8) Support the Department of Defense Advanced Distributed Learning initiative.

TADLP Program Assessment. In December 1999, the TRADOC Program Integration Office, for The Army Distance Learning Program, chaired a work group responsible for: assessing the current TADLP Master Plan strategy and objectives; determining strategy weaknesses; and providing recommendations to Army leadership to keep TADLP current and relevant. The centerpiece of this assessment was the set of technical and functional requirements established by ADL. The associated recommendations and decisions has become the springboard for TADLP Master Plan updates.

Assessment recommendations and requirements include:

Facilities – Continue fielding DTFs to the USAR in the Continental United States (CONUS). Reduce CONUS Active Component fielding by 30 percent. Continue to field Active Component overseas (OCONUS) locations, IAW the plan, due to immature infrastructure.

Courseware – Develop courseware to HTML standards with capability to deliver via Internet-ready CD-ROM, Internet, and CD-ROM/Internet Hybrid courseware. Continue to move toward SCORM and XML standards. Document standards in Army Training Information Architecture (ATIA).

Authoring Systems – Transition to multiple authoring systems when they demonstrate the ability to import/export and change standards-based courseware reliably.

Technology – Partner with STRICOM. Appoint Army Training Support Center (ATSC) as the TRADOC focal point for seeding new technology. Collaboration with other services is critical. Test and integrate new technologies. Continue participation in related on-going activities (e.g., TFADLAT, Army Science Board, Secretary of the Army Training Technology Subcommittee, etc.).

HQ TRADOC Deputy Chief of Staff for Training (DCST) approved TADLP Strategy Assessment recommendation for implementation.

The Army's way ahead includes:

- Fielding of a 21<sup>st</sup> Century Learning Management System is imperative.
- Increase collaboration with other services.
- Focus on courseware / content production.
- Research soldier access using soldier-owned computers.
- Ensure linkage of the Army Knowledge Base (Reimer Digital Library, Center for Army Lessons Learned, University After Next, etc.).
- Fully integrate the Army Training Information Architecture (ATIA).
- Test HTML/ JavaScript import/export functions of authoring systems as security issues are worked.

4.1.3.2 **Navy.** The Chief of Naval Education and Training (CNET) is responsible for overall design and implementation of Navy's ADL Program. The Navy Learning Network (NLN) is being designed to provide Navy-wide connectivity to its Active Duty, Reserve and Civilian personnel via a single, integrated on-line learning architecture. It will provide "on demand" access to web-delivered courses; libraries of courses delivered in schoolhouses and Learning Resource Centers, by CD ROM or VTT; links to available education and training information; and on-line group discussion capabilities. NLN will stand up in Summer 2000 and be accessed via the web site of *www.navylearning.navy.mil*. It will grow incrementally as web-based courseware is procured from industry and existing Navy courseware is converted for web delivery. NLN will also manage, track and record course usage and completions through an automated Learning Management System (LMS) product. Users will have support of a 24-hours-a-day, 7-days-a-week help desk.

NLN will support a wide range of interactive multimedia instruction (IMI) including real-time full-motion video and audio, as well as document sharing and collaborative communications with instructors, experts and other learners. This also means there will be a variety of IMI format types, some of which will be bandwidth intensive. Therefore, the architecture has to account for bandwidth implications, the role of hybrid distributive media formats, and emerging media technologies, such as desktop video conferencing, streaming media, and voice applications.

The Navy has started the process of reviewing its approximately 4,000 formal courses to determine appropriateness for conversion to web-based delivery. However, the focus of the review will shift from the present schoolhouse model to a career continuum learning model to effectively support the NLN strategy. Criteria are being established for making decisions about learning that needs to be supported at various stages in the career continuum.

The methodology for selecting instruction for the NLN must look at career continuums for officers and enlisted personnel, as a whole, to identify the appropriate mix of resident and distributed learning across career stages. The methodology also needs to look across continuums to identify common or core instructional units and opportunities for reviewing instruction.

The roles and responsibilities of learners, instructors/professors and managers will need to change in the learner-centered ADL environment. Traditional instructors and professors will still be needed, but so will facilitators, mentors, and experts. All will play a part in interacting with the learner -- to tutor, coach, monitor, manage, and provide assistance so that he or she will learn new skills and knowledge. Finally, a common finding in higher education is that teachers who use advanced distributed learning often spend more time interacting with their students and class than they did when teaching the class in the traditional lecture method of instruction. This occurs because they need to communicate more frequently and individually with students through e-mails and electronic forums. The Navy will be able to leverage off the experience of commercial organizations and educational institutions that have implemented successful ADL programs to see how they have shifted the instructor/professor's role from teacher-centered to learner-centered.

**4.1.3.3 USMC.** The Marine Corps Distance Learning Program (MCDLP) is a fully-funded program scheduled for FOC in FY 05. Appendix 1 contains a portion of the budgeted amounts relating to program execution over the FYDP. The Mission Need Statement (MNS) TNG 1.23 (Marine Corps Multimedia Infrastructure), dated 4 August 1994, primarily supports the Operational Requirements Document (ORD) for Distance Learning (DL). Marine Corps DL are also supported by the following MNSs: Modeling and Simulation Tools in Support of Operations (TNG 1.33); Marine Corps Modeling and Simulation Centers (TNG 1.30); and Simulations and Simulators for Marine Air-Ground Task Force (MAGTF) Training (TNG 1.34).

A major component of the MCDLP is the MarineNet. This is a Marine Corps-wide, distributed intranet that will enable Marines to learn via the appropriate interactive media, when and where the learning is needed. DL, via the MarineNet, is not a total replacement for resident training. Some courses of instruction are inappropriate for DL, and traditional resident training may best suit the needs of the Marine Corps in selected areas (e.g., recruit training, Marine Combat Training, and basic infantry skills training, etc.). Some courses of study (e.g., nonresident Professional Military Education (PME)) may be appropriately delivered completely via DL. Other courses of study may be presented via a combination of resident instruction and DL. MarineNet will provide a greater population of Marines access to learning resources. The efficiencies generated by DL will enable the Marine Corps to increase manning in the operating forces by shortening the "Street to Fleet" process through just-in-time DL.

The Director, Distance Learning (DLC), Training and Education (T&E) Division, Marine Corps Combat Development Command (MCCDC) is the functional manager of the MCDLP. The DLC is responsible for establishing standards for the design and development of DL products for PME and Military Occupational Specialty (MOS)

training, including courseware. Additionally, the DLC is responsible for training DL trainers and technical support for the system. The Program Sponsor for the MCDLP is the Training and Education Division. T&E Division has the overall management, administration, and budgeting responsibility for Marine Corps training.

**4.1.3.4 Air Force.** The scope of AF ADL efforts through current instructional technology is significant. In 1999, ADL enrollment in AETC alone included: 33 Professional Military Education (PME) ADL courses in 9 major programs with 46,000 students; 37 AF Institute of Technology (AFIT) ADL courses with 17,200 students; 15 professional continuing education (PCE) courses with 1,999 students; 380 career development courses (CDCs) with 160,000 students; and 31 specialized courses with 1,522 students. There are also 109 Technical Training, Supplemental and Craftsman Courses. The total is over 600 ADL courses with an enrollment of over 226,721 students. New ADL efforts are increasing in other MAJCOMs and functional areas to meet mission requirements. For example, the AF Communications Agency licenses about 1,000 information technology web-based ADL titles that are used for CBT upgrade training and certification by communications and information airmen and officers.

**Active Air Force.** Over 95 percent of AETC formal courses have been evaluated for alternate delivery through a contracted assessment in FY 99. One hundred and twenty eight courses have been identified for conversion to ADL, technology insertion, or a combination of both based on a six-year return on investment (ROI). Additionally, AETC plans to convert all existing electronic courses to ADL-compliant media over time, depending on funding. These actions do not all have a positive return on investment for conversion and will be converted as funds become available. Before FY 04, MAJCOM-specific and ancillary courses will be evaluated for possible conversion to ADL, with course conversions starting in FY 04. AETC is submitting a consolidated ADL POM input for FY 02 to cover the contracted course conversions and course maintenance of most of the 128 courses. Many courses will be converted in-house by Instructional Technology Elements. Course conversions will be accelerated if resources permit.

**Air Force Reserve.** The AFR is primarily a customer of Active AF courses. AFR personnel follow requirements established by the Active AF and attend AF-owned/developed courses.

**Air National Guard.** The ANG participates in Active AF ADL courses and generates satellite-delivered AF PME (NCO Academy) to ANG sites. ADL courses help ANG members to overcome several challenges—classroom seats, limited per diem, and demanding civilian work schedules. The ANG also initiates courses to satisfy training required by Weapons of Mass Destruction, Counter Drug and Home Defense missions. Additionally, the ANG collaborates on training issues initiated by other services or government agencies and has used ANG resources to support its ADL training requirements.

**4.1.3.5 National Guard Bureau.** As the U.S. military downsizes in response to the end of the Cold War, a smaller National Guard (NG) has taken on new, more complicated roles.

The National Guard Bureau and its ARNG and ANG components carry out training to support its role as an integral element in the nation's ability to conduct combat operations and operations other than war (e.g., Bosnia peace keeping). In addition to its federal mission of supporting the Army and Air Force, the National Guard has an additional role as a community-based force. As part of this state role, the National Guard has unique requirements for Stability and Support, Domestic Support, and Homeland Defense Operations. The National Guard has increasing responsibilities for responding to Weapons of Mass Destruction (WMD), counter- drug activities, Partnership for Peace missions, Emergency/Disaster Management, military Base Support Operations, Information Operations, and Youth Challenge programs. In order to identify, assess, and prioritize the technology, learning support, business process, and leadership and culture requirements for implementing ADL as an enterprise-wide solution for the Guard's learning challenges, the Guard has instituted several institutional forums. The following describes the needs identification and resolution frameworks being implemented to facilitate ADL in the National Guard:

The Chief, NGB (CNGB) has been designated by Congress as the Executive Agent to conduct the National Guard distance learning project, also known as the National Guard Distributive Training Technology Project (DTTP). NGB is responsible for the overall design and implementation of the network backbone, delivery system, software, equipment installation, integration, and facilitating courseware availability. The program has the additional responsibility of establishing and promoting civil and governmental shared usage of the DL sites on a space available, reimbursable basis.

The DTTP must be coordinated with networks, courseware development, staff and faculty training, support services, and business operations in order to achieve the objectives of the evolving National Guard Advanced Distributed Learning Strategic Plan. To this end, the NGB has established a Requirements Control Board (RCB) with its mission to provide a single source for coordination, final prioritization, and approval of DTTP functional and technical requirements in support of the NG Advanced Distributed Learning Strategic Plan.

The RCB represents multiple customers. The principal customers are the states, territories, and the District of Columbia. Because the National Guard is represented by two entities - the ARNG and the ANG - these entities are represented within the Product Management Office (PMO) and Program Executive Office for Information Systems (PEO IS) by a Customer Focus Team (CFT) comprising senior representatives from both the ARNG and ANG.

The RCB in essence, serves as the nexus for the multiple federal and state-level processes created by the Guard to identify, define, and prioritize DL related requirements. These processes provide opportunities for discussion on requirements in the following areas: learning support resources; technology systems; business processes; and culture change and DL leadership. The processes include: the Configuration Control Board (CCB), DTTP IPT, and DL IPT; the Joint Systems Engineering Integration Group (JSEIG); DL Strategic Planning workshops; metrics process; monthly PEO reviews of "success stories;" monthly audio-conferences with state DL Points of Contact (DL POCs); regional video

teleconference “virtual lunch breaks” with DTTP site administrators and others; DL symposium for the courseware development community; and semi-annual DL conferences for the Guard training community.

Other customers of the RCB include: Congress, Department of Defense oversight bodies, the Departments of Army and Air Force, shared-use partners, and the American taxpayer. The RCB serves as an integrating process for balancing the user's needs with researching alternatives, defining requirements, allocating resources, determining priorities, measuring technical and operational performance, and establishing an operational and support capability.

The National Guard has a unique role as both a federal and state force; therefore, understanding the federal/state relationship is a key factor in the successful implementation of DL throughout the National Guard. The transfer of federal appropriations and equipment to the states is accomplished in an assistance relationship called a Cooperative Agreement. Cooperative Agreements allow the federal government to offer assistance to the states, which they can accept or decline. If the states accept the federal assistance, they are bound to operate within the framework. Title 32 of the United States Code defines this unique relationship and provides by statute separate transfers of assistance and support to the National Guard of the states, territories and the District of Columbia (examples of this are the military and technician pay system, the military supply system, etc.).

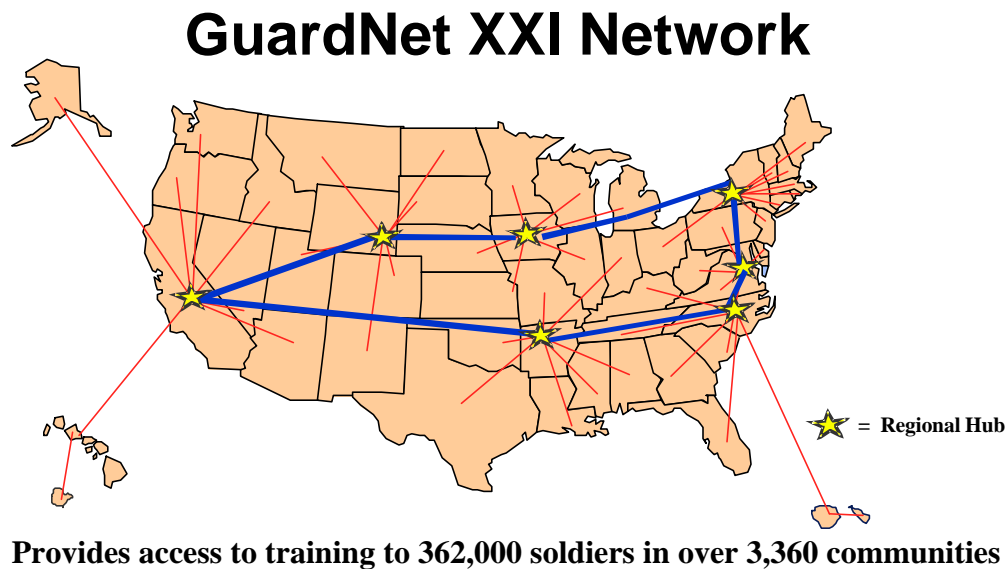

**Figure 6.** The National Guard’s “GuardNet XXI Network”

The Guard is also engaged in several proof-of-concept activities. One such proof of concept is designed to develop tools, models, and guidelines for identifying DL resource development and/or conversion priorities with potential for high impact on individual and

unit readiness. This proof of concept, and its resulting model and guidelines, will establish value to stakeholders including: the Guard; the Department of Defense ADL Initiative (ADLI); the federal, state, and industry DL community; and Congress.

The National Guard, and the Army and Air Force’s active and reserve components have initiated opportunities for distributed learning coordination and are continuing to expand areas of collaboration. These areas include: facilitating interoperability between networks and classrooms; leveraging classroom fielding to expand access opportunities; extending the reach of instructional programs; and developing resources that support learners and instructors in order to maximize learning activity outcomes. Several of these efforts have been integrated into the processes and adjunct activities of the Total Force Advanced Distributed Learning Action Team membership. The Guard intends to continue to implement institutional frameworks and developmental activities to ensure that learning-related readiness and Guard-unique mission requirements are identified and met effectively and efficiently through ADL.

## 4.2 Task Two - Setting Goals and Milestones

4.2.1 **Defense Courses for Conversion.** It is the department's goal to have each of the Military Departments, Joint Staff and Agencies annually develop a list (as of each October) of their planned courseware conversions. The list will show the scheduled conversions for the new fiscal year, the ongoing conversions, and the initial estimate of plans for conversion for the following two years. It is understood that the later estimates and plans will change and be refined prior to the year of actual conversion. It is the department's goal to have the components identify and share, to avoid duplication, courses appropriate for conversion to ADL. Most of the Military Departments have conducted detailed studies to determine what can or should be converted. The Joint Staff, the Joint Professional Military Education communities, and the Department of the Navy may provide initial data pending conclusion of their analyses. As part of this process, components will provide the total list of courses slated for conversion in priority order, including the scheduled year and dates for conversion. Summaries of the military components’ current goals for course conversion are provided below.

Conversion of Existing Content to ADL Media (Hours)							
	<i>FY00</i>	<i>FY01</i>	<i>FY02</i>	<i>FY03</i>	<i>FY04</i>	<i>FY05</i>	<i>TOTAL</i>
<b>AIR FORCE</b>	203	142	386	384	354	72	1,541
<b>ARMY</b>	3,045	2,042	3,978	4,926	5030	5,892	24,913
<b>NGB/PEC</b>	620	812	990	807	807	807	4,843
<b>NAVY</b>	0	282	243	227	47	0	799
<b>USMC</b>	189	200	200	200	200	150	1,139
<b>TOTAL</b>	4,057	3,478	5,797	6,544	6,438	6,921	33,235

**Figure 7.** Current Goals for Course Conversion

4.2.2 **Joint Staff.** In FY 00 a JVLE Requirements Baseline was developed. The JVLE Program Office conducted a requirements survey of a selection of CINC, MECC schools, and Regional Centers (a number of regional schools have been established to



foster democratization through education in Europe and the Pacific to name two). The JVLE Team prioritized the resultant requirements document, and the JVLE Executive Committee validated those prioritization recommendations. Each following FY of the JVLE Program Plan a re-validation will be conducted of the approved JVLE Requirements Baseline by Department of Defense customers and sponsors followed by re-validation and approval by the JVLE Executive Committee.

JVLE is being developed in a multiple-phase approach. Phase I, concept and prototype development, is complete. Subsequent phases with planned goals and milestones include:

The Phase II efforts are in two parts:

- Part 1 - build upon the work done during Phase I, as a proof of concept and JVLE capabilities demonstration, and produce a working architecture with a version 1.0 set of associated tools; and
- Part 2 - incorporate the Regional Centers into the JVLE system.

Specific Requirements - Phase II, Part 1.

Requirements Validation. The JVLE Team validated the current JVLE requirements, represented by the Phase I demonstration, with key representatives of the MECC schools and CINC staffs. The resultant list of requirements was prioritized and provided in a report. These requirements formed the basis for JVLE 1.0, and will provide a living JVLE-requirements baseline for future JVLE work.

Joint PME Courseware Identification, Creation and Tagging. The JVLE Team will focus the existing work to find available courseware and to define new learning objects for the JVLE. The JVLE Team shall convert the available joint courses into JVLE-compatible learning objects, appropriately modularized and tagged for utilization in the JVLE.

Joint-Force Learning Objects. The JVLE Team will construct a collection of learning objects beginning at the unit/element level (ship, aircraft, tank, etc) that describe the missions, capabilities, limitations and employment of each of the service's basic operational forces. Each of the unit/element learning objects would serve as building blocks for higher-level force elements. This object-oriented/modularized, building-block approach will introduce the basic organizational structures and describe in general terms the capabilities, limitations and employment of each block. This will be the first step toward creating the analytical and simulation tools required to game or explore the capabilities and limitations of various force structures within the JVLE.

Learning Object Metadata-Tagging Tool Development. The JVLE Team will develop a tool, which will allow the MECC faculties and CINC users to tag identified PME learning objects, for insertion into an appropriate JVLE repository. The tool will be either an extended development from the efforts of the Phase I prototype, or will be a tailored COTS tool. The tool will enable users to migrate their legacy content into the "tagged" environment of a MECC school or CINC object repository, in conformance with the Sharable Courseware Object Reference Model (SCORM) developed as part of the

Department of Defense Advanced Distributed Learning (ADL) Initiative. The tool will be associated with the JVLE version 1.0 toolset, but will be implemented as soon as possible to promote the population of JVLE repositories with CINC/MECC PME courseware learning objects.

COTS/NDI Application/Tool Analysis. The JVLE Team shall conduct a market survey and analysis of available COTS/NDI tools and applications, which may meet the requirements collected previously for JVLE version 1.0. The analysis will include the existing tools developed under Phase I of the prototype, and will result in a subjective set of trade-offs and recommendations for use in the JVLE version 1.0 implementation.

JVLE Version 1.0 Architecture and Design Development. Based upon an approved set of COTS and developmental tools/applications from the previous requirement, the JVLE Team shall produce a design for JVLE v.1.0. The JVLE Team will develop an architecture for the overall JVLE, including distributed repositories, interfaces, and connectivity. The actual toolset design and integration concept will include only those approved requirements targeted for the JVLE tools in version 1.0.

JVLE Version 1.0 Implementation. Upon approval of the design, the JVLE Team shall develop the JVLE version 1.0. The implementation shall include a minimal set of documentation and worldwide accessibility for MECC and CINC users.

Specific Requirements - Phase II, Part 2.

Requirements Analysis. The JVLE Team will conduct a requirement analysis to determine what is needed to interconnect the Regional Centers into the JVLE prototype.

Regional Centers Connection. The JVLE Team will connect the Regional Centers into the JVLE prototype and set up a repository for learning objects at each of the Regional Centers.

Courseware Conversion and Storage. The JVLE Team will assist the faculty and staff of the Regional Centers in converting an initial set of courseware into learning objects and storing the learning objects in the repositories.

Learning Object Usage. The JVLE Team will assist the faculty and staff of the Regional Centers in creating and using learning objects for development and exchange of lessons, modules, courses, curricula, research projects, lessons learned, and faculty collaboration projects.

Knowledge Exchange. The JVLE Team will demonstrate to the faculty and staff how to exchange knowledge through the use of learning objects.

Outcomes Assessment Report. The JVLE Team will provide an Outcomes Assessment Report documenting the findings of the requirements analysis, outlining prototype and

faculty success, and recommending solutions to problems encountered. The Report will also outline recommendations for future involvement and required funding levels.

#### Specific Requirements - Phase III-FY01.

**Management Oversight.** Provide management oversight, and associated program management and business services. This includes attendance at selected Education and Training Conferences, JVLE-PMO Internet Homepage maintenance, JVLE orientation and executive information sessions, and other similar tasks required and authorized by the JVLE PMO.

**Requirements Revalidation.** Re-validate JVLE Requirements Baseline with Department of Defense customers. The JVLE Team will distribute the JVLE Requirements Baseline to its core JVLE user institutions (CINC, MECC, and Regions) for comment and validation. The resultant modified requirements document will be presented to the JVLE Executive Committee for approval, along with any explicit program changes that also may be required to meet the new requirements baseline.

**Procurement and Fielding.** Begin procurement and fielding of JVLE Repository Backbone to specified Department of Defense customers. The JVLE Team will utilize the JVLE Architecture developed during Phase II, as the basis for procurement and fielding of an incremental number of JVLE repositories to specified Department of Defense user sites. Determination of which sites are to be recipients of the JVLE systems and repositories will be recommended by the JVLE Program Office, and authorized by the JVLE Executive Committee. The objective during FY 2000 is to field 20 sites with JVLE repository capabilities.

**Operation and Maintenance.** Provide Operation and Maintenance (O&M) to selected/qualified JVLE Customers. The JVLE Team will institute an O&M capability, providing remote JVLE repository systems monitoring, remote preventive maintenance, remote software upgrade capability, and remote troubleshooting capabilities. The remote O&M capability will be augmented by a mobile O&M team who can respond to any catastrophic faults, as required, within the JVLE fielded infrastructure.

**Help Desk.** Provide JVLE Help-Desk. The JVLE Team will institute a JVLE Help-Desk capability. The Help Desk will have the capability to respond to both JVLE maintenance and user queries, via telephonic and e-mail means.

**Courseware Development.** Begin developing selected Department of Defense Joint Course Content for JVLE. The JVLE Team shall institute a program element that will focus on creating state-of-the-art Network-Based Learning (NBL) courseware, for Department of Defense users of the JVLE. The courseware will focus upon Department of Defense joint requirements, and will be selected based upon JVLE Program Office suggestions and JVLE Executive Committee approval. Depending upon available funding, the objective is to create at least one joint NBL course for JVLE repository utilization. The objective for FY 2000 is to create 5 joint courses.

Conduct JVLE User Training. The JVLE Team will institute a JVLE training capability. JVLE training will be developed to be optionally presented as: resident training to various user types (commanders, staff officers, teachers, students, and researchers), as an NBL-based course facilitated by JVLE trainers, and as a stand-alone course expanding upon the initial courseware developed as part of Phase II. After JVLE training materials are developed the JVLE training element will be prepared to conduct and facilitate training for Department of Defense users, as resources allow.

Additional Functionality. Develop JVLE version 2.0 in accordance with selected additional features represented by JVLE Requirements Baseline. The JVLE Team will add additional functionality to the JVLE system, based upon requirement prioritization and funding availability. The JVLE design team shall base all additions and improvements to the JVLE system upon an industry COTS survey to determine if there is an existing application which meets JVLE requirements and can be integrated into the system. The JVLE team will only develop software to meet JVLE requirements if no COTS solutions are available for integration. The new version JVLE will be tested before fielding, to ensure it operates as designed and meets those requirements from the JVLE Requirements Baseline.

JVLE Version 2.0 Fielding. Field JVLE version 2.0 to appropriate Department of Defense customers. Upon successful JVLE version 2.0 integration/development and testing, the JVLE version 2.0 will be ready for fielding. As much as possible, fielding will be accomplished using remote capability. If and as required, a JVLE version 2.0 fielding team will travel to JVLE sites to upgrade those sites from the old version.

**4.2.3 Joint Forces Command.** Joint Forces Command's current plans are focused on developing the operational requirements and technical standards that will guide the development of a joint distributed learning environment called the Joint ADL Network, establishing strategic partnerships among major stakeholders, planning an initial set of demonstrations and assessments, and conducting site surveys for the Joint ADL Network requirements. See Appendix 4 for detail on the evolving and working plan of action for the Joint Advanced Distributed Learning Network Architecture.

FY 01 – Initial Development. The major effort is expected to include developing a proposal to conduct one advanced concept technology demonstration (ACTD), establishing a Joint ADL Network testbed, and participating in IDA ADL Co-Laboratory demonstrations and assessments. It should be noted USJFCOM developed an ACTD proposal, which must still go through a coordination and approval process. Planning will continue for future demonstrations and assessments, and site surveys will be continued.

FY 02-03 – Demonstration and Certification. The major focus of effort in FY 02 and FY 03, in addition to ongoing demonstration work, will be to complete assessments of the operational and technical architectures through the use of the Joint ADL Network testbed and the IDA ADL Co-Lab. Required Validation, Verification, and Accreditation of the

system components of the network, final site surveys, and program management efforts will be completed.

FY 03 – IOC. If approved the ACTD Demonstration Phase is expected to be completed in FY 03. At this point the Transition Phase begins and the Initial Operational Capability (IOC) of the Joint ADL Network is established. At IOC, the Joint ADL Network will be functional and capable of supporting the JVLE and the Joint ADL Network portal. At least one network pathway will exist to deliver baseline learning resources to all critical nodes. Basic tools and services will have been identified, mapped, and certified to support mission applications. Out-year planning for additional demonstrations, site surveys, and program management will continue.

FY 04-05 – Expansion and Certification. The major efforts in FY 04 and 05, in addition to ongoing demonstration work, will be to complete the identification, mapping, and certification of all required network tools and services. Additional network gateways and redundant pathways will be established to create a fully redundant and robust network.

FY 06 – FOC. At Final Operational Capability (FOC), the Joint ADL Network will be fully functional and will be expanded to support additional mission applications, such as mission rehearsal. Network pathways will be expanded to accommodate additional nodes. Additional network tools and services will be identified, mapped, and certified to support other mission applications.

4.2.4 **Army.** The Army is taking a multifaceted approach and has modified its standing plans to achieve the following goals and objectives:

The ADL initiative seeks a balanced funding ratio between course content and Infrastructure development. Army current and planned investment has resulted in a ratio of 40 percent courseware to 60 percent infrastructure investment.

New training content is being developed that supports the ADL Initiative vision of training anytime, anywhere. Effort is under way to integrate the SCORM into DL course content to enhance the capability to share and reuse learning objects across the Department of Defense. All Army components have embraced the distance learning concept, and synergism within the Army community has resulted in efficiencies, increased effectiveness, and the development of innovative ideas that will benefit all services.

Army courseware R&D efforts have opened many doors and paved the way for the Army DL course content development. R&D has provided the Army with the insights required to develop distance learning training that ensures the proper balance between content distribution and educational sufficiency. The heart of distance learning is the efficacy of the training content that will be provided to soldiers anywhere anytime. This effort includes:

- To facilitate distance learning content development, the Army began with the basic redesign of formal Army training courses to TATS courseware format. This action

provided standardized courseware for all components and established a pool of courses ready for redesign for distance learning.

- Redesigning the content of approximately 30% of the Army courses (over 500 courses) for delivery through multiple technologies. Courses are selected for DL based on three principal factors: (1) Improvement of Force Readiness; (2) Suitability of content for distance learning media; (3) Potential return on investment (e.g., increased student throughput, or reduced course overhead and per diem costs).
- The Army is programmed to redesign courses to distance learning media at the rate of 31 courses per year through FY 2002 and 47 per year through FY 2010.
- Course content will be designed for delivery via multiple means such as Internet, Internet-enabled compact disk (CD), or a hybrid mix of CD and Internet. Internet-

enabled CD offers soldiers the flexibility to access the Internet, if available, or to receive quality training directly from an interactive CD.

The Army is evolving its distance learning facilities and is moving to web-based training to meet the ADL requirement to deliver training anytime and anywhere. The need to deliver training through DTFs, as established in the April 1996 Army Distance Learning Plan, is still critical during the early stages of the Program. At this stage, DTFs offer several advantages:

- Security risks and access vulnerabilities associated with crossing the “dot com” and “dot mil” domains are avoided.
- Soldiers will have the capability to freely access Army training materials from locations that have a C2 security level.
- Efficiencies will be gained by establishing integrated network systems and centralized workstations rather than upgrading or installing necessary communications wiring in every soldier’s quarters and duty location.
- Provides standard equipment and software that ensures its compatibility with reusable course content.
- Ensures effective learning management (e.g., student, lesson, and course management).
- Helps meet the Army’s goal to provide access to DL training resources within 50 miles of 95 percent of the Army population, which includes access by the Reserve components.
- Supports students, who are new to distance learning, training 24 hours per day, 7 days per week.

**4.2.5 Navy.** Based on resource availability, the goal of the Navy is to target a minimum of 25 technical and/or educational courses to begin the conversion process for web-delivery or to be web-enabled, each year (see Appendix 2). These will be added within the context of the Navy Learning Network’s (NLN) complete architecture. The implementation of NLN

will change the roles and responsibilities of not only the instructors, but also the learning management and support personnel, as well as the learners themselves.

One of the goals of successfully implementing NLN is to analyze the potential criteria for prioritizing Navy pipelines for career learning continuum development. This will include assessing:

- Impact on Navy readiness
- Changes in Navy missions that dictate new training requirements
- Existing deficiencies
- NEC consolidations/cancellations/reclassifications
- Need to increase officer access and completion of postgraduate education and PME
- Percent of total number of sailors required for the rating
- Training capacity constraints and excessive student awaiting-instruction accounts
- Return on investment.

A detailed evaluation plan has been developed to assess attainment of goals. Evaluation will be an ongoing process throughout the life of the system. The evaluation strategy is designed to support decisions for assessing learning effectiveness and costs, planning for updates and modifications, and assessing the life-cycle operation and maintenance of the system. Evaluation of the NLN system will cover a broad range of metrics including user acceptance, learning efficiency and effectiveness, and system effectiveness. All of this must provide a return on investment (ROI) that allows the Navy to enhance the system over its life and allocate funding to achieve the highest payoffs.

One measure of success of the NLN is to capture the ROI. The payback for this technology application will include shortening in-residence requirements, expanding education and training opportunities, accessibility and capacity and providing improvements in education and training quality.

A fundamental benefit of ADL technology is that it allows the Navy to deliver education and training to multiple locations without having to create infrastructure for individual courses at each location or send instructors to these locations. Investment in this technology will shorten schoolhouse-based pipelines, accommodate changing demographics, make proficiency training readily available Navy-wide, and save costs. This means we will get Sailors to the Fleet faster, keep them there longer, and more efficiently maintain their levels of skill proficiency.

4.2.6 **USMC.** To help the Marine Corps meet the challenges of the 21<sup>st</sup> Century, the Marine Corps Combat Development Command's Training and Education Division has developed the *Training and Education Modernization Initiative*. The objective of this initiative is to maximize the Corps' limited training and education resources by restructuring current institutional training; improving training design development and training management processes; introducing technology into classrooms; and capitalizing on modern distance learning technologies.

DL is a major component of the *Training and Education Modernization Initiative*. DL technology has the potential to dramatically change the way we train and educate our Marines in the future. Investment in DL technology will transform Marine Corps training and education from a centralized, formal school-based, instructor-centered environment to a more distributed, learner-centered approach. USMC investment in technology will be driven by operational readiness requirements, and will be focused on improving both the effectiveness and efficiency of the training and education programs provided to our Marines. The outgrowth of this initiative is the Training Development System (TDS). The goal is to achieve a 30 percent reduction in training time. The Marine Corps DL Program is only one component of the larger TDS process.

Objectives of the MCDLP are to:

- Develop “world class” interactive multimedia instruction (IMI);
- Deliver network-based IMI to any connected workstation meeting the Marine Common Hardware Suite baseline;
- Provide a dedicated video teletraining (VTT) capability that supports the training and education of Marines; and
- Leverage on other programs, like the Marine Corps Base Telecommunications Infrastructure and the Reserve Network (R-Net) upgrades, thus taking advantage of high-bandwidth intranets.

Future annual content development objectives are ten MOS/Skill courses, five PME courses, and three cross-functional (general) courses, for a projected target of eighteen courses per fiscal year. Appendix 2 contains a detailed list of the FY 99 and FY 00 course conversion list.

**4.2.7 Air Force.** Consistent with the AF DL Roadmap, the AETC ADL Implementation Plan, and the contracted Booz-Allen & Hamilton evaluation of AETC resident courses, the initial AF ADL implementation will result in conversions of AETC courses. In Fiscal Year 2000 (FY 00), 10 technical training courses will be converted to ADL. In FY 01, 5 technical training courses will be converted. From FY 02-07, a combination of 15-20 education and training courses will be either converted to ADL or technology insertion each year.

In FY 01, the AF is planning to accomplish an infrastructure analysis, as well as analyses of ancillary courses and MAJCOM-specific courses in preparation for the FY 02 POM build for FY 04. These analyses will lay the groundwork for the start of funded course conversions of MAJCOM-specific and ancillary courses in FY 04. The infrastructure analysis will form the basis for any infrastructure improvements for ADL in FY 04-09. The difference between the current and future infrastructure will be installed to allow delivery over the ADL System architecture.

In FY 01, AFIADL will begin implementing AETC/ED’s vision of an in-house or contracted course conversion, maintenance, and development capability in support of course conversions over the FYDP. AETC/DO will continue design, development,



delivery, and student management of technical and flying training requirements through existing contracts and in-house Instructional Technology Elements. Additionally, in FY 01 AFIADL will evaluate learning management systems (LMS) that could possibly replace the aging Curriculum Development, Student and Registration (CDSAR) system at AFIADL. This LMS must be in place for the SCORM-compliant courses that are developed in FY 02.

The AETC ADL Implementation Plan supports the Secretary of Defense's objective to reduce up to 30 percent of resident training classroom time and increases the use of ADL. In FY 02 AETC will implement an ADL open-architecture, integrated system using the Department of Defense Network to provide high-reliability connections among AETC organizations, customers, and suppliers for the accomplishment of ADL. The system: stores content in a joint digital warehouse; delivers, administers, tracks, and accomplishes student management functions via a LMS; and provides interim affiliation with the ADL Co-Laboratory and the Institute for Defense Analyses for testing and evaluating emerging standards.

AFR. The AFR has no courses for conversion to ADL. AFR personnel attend AF-owned courses for all aspects of formal training. Three-, five- and seven-level upgrade training, qualification training and ancillary training requirements are met through active AF agencies.

ANG. The ANG is pursuing an aggressive goal of converting identified courses to the appropriate format. Current initiatives include analysis of courses for conversion via the USAF Total Force Training Review IPT and Training Corporate Review process. The ANG is staffing the course candidates through the Career Field Managers (CFMs) with a follow-on to course developers. Once the review is completed, the ANG will be able to project an annual timeline for course conversion. The ANG currently has seven courses under development for ADL. Six more courses are scheduled to be developed. Fourteen additional courses will be evaluated for their potential for conversion to ADL.

**4.2.8 National Guard Bureau.** In order to accelerate implementation of ADL throughout the National Guard, a strategic planning workshop was held in September 1999. This meeting brought together education, training, state command, recruiting/retention, and functional area stakeholders from throughout the NGB, the ARNG, the ANG, and the Department of Defense ADL leadership. This workshop produced a comprehensive set of draft goals and objectives. These draft goals and objectives are currently being staffed and reviewed by the National Guard leadership and will be presented and discussed throughout the Guard at the federal and state levels over the next several months. The draft National Guard Bureau goals and milestones are:

- The culture of the National Guard at all levels understands and supports ADL. The objectives for FY 01-04 focus on establishing and institutionalizing policies and procedures to speed ADL acceptance.

- ADL will be the primary learning delivery method for the National Guard. FY 01-04 objectives focus on: ensuring interoperability among all ADL instructional platforms, media, and tools; durability to withstand base technology changes; reusability among applications, platforms, and tools; and cost effectiveness.
- National Guard operational practices support learning anytime/anywhere. FY 01-02 objectives focus on requirements control, enterprise-wide DL integration, and optimizing use of technology.
- The end-state envisions universal use of Advanced Distributed Learning (ADL) components. FY 01-06 objectives focus on staffing ADL facilities, establishing a Learning Management System, and transition to learner-centric learning products.
- Partner with other federal, state, public, and private agencies to leverage resources and information. FY 01-06 objectives focus on: capitalizing on interoperability between the ARNG GuardNet XXI and ANG Warrior Net; increasing resources to the states; and institutionalizing collaboration internally and externally.
- Value-based decisions emphasize fiscal, resource, and environmental accountability and responsibility; thereby leaving a legacy of good stewardship for those whom follows. FY 01 objectives focus on encouraging best business practices, and leveraging ADL in recruiting and retention efforts.
- All Advanced Distributed Learning (ADL) components are resourced. FY 01-02 objectives focus on: validating federal mission related DL requirements in the POM process; and resourcing ADL system components to ensure optimal efficiencies, refreshment, sustainment, and effective management.

Strategic initiatives, such as the Guard's DL effort, are faced with challenges, including rapidly evolving technology alternatives, staffing and management requirements, funding levels and restructuring, and leadership and cultural change issues. The discussion that will take place over the next several months regarding these draft goals and objectives will be instrumental in institutionalizing and mobilizing stakeholder support for development and implementation of the Guard's enterprise-wide distributed learning capability.

#### **4.3 Task Three - Monitoring and Measuring Progress.**

Successful implementation of the ADL Initiative requires development and application of methods to monitor and measure the progress of the entire department as well as that of the individual components. A number of potential metrics are being identified as a result of collaborative efforts within the department. In follow-on activities, the Total Force ADL Action Team will provide a list of common metrics to the ADL Executive Steering Committee for review, refinement, and approval. Criteria being applied now to decisionmaking and management processes for funding Department of Defense components with regard to distributed learning are expressed in the questions below.

**Is your organization able to:**

- Balance content development and distribution with infrastructure development?
- Develop management software that is robust enough to record and manage student progress anytime and anywhere it is needed (learning management systems)?
- Yield a reasonable return on investment in terms of readiness and/or savings within five years?
- Include provisions to assess and document the costs and benefits for the first three years after fielding?
- Develop products that will be operable (given the rapidly changing technological environment) for the next three years?
- Make a deliberate attempt to collaborate and leverage investments of others within and outside of Department of Defense?
- “Interoperate” with other distributed learning programs across Department of Defense?
- Support education, training, and on-the-job performance aids?
- Support the needs of active and reserve components?
- Support the needs of the joint community?

**4.4 Task Four – Establishing a Science and Technology Base**

The Deputy Under Secretary of Defense for Science and Technology (DUSD (S&T)) focus on Cognitive Readiness supports research initiatives to accelerate the development of Department of Defense’s ADL capability. Cognitive Readiness emphasizes the importance of the human dimension of war and the potential for advances in cognitive performance to become a revolutionary war-winning capability.



### Figure 8. DUSD (S&T) Focus on Cognitive Readiness

In October 1999, the DUSD (S&T) and the Director of Bio Systems hosted a four-day meeting to develop a supporting front-end assessment and to conduct an expert review of research requirements for Advanced Distributed Learning.

The front-end assessment and expert review produced a consistent picture of an envisioned end state for a robust ADL capability by the year 2012 (“*ADL in 2012*”) and the S&T research necessary to achieve that desired end state. The ADL initiative grew out of the Department of Defense strategy to “harness the power of learning and information technologies to modernize education and training.” This effort is currently in the “prototype stage.” Current ADL successes are typically labor intensive and not transferable from one subject to another. To realize the robust ADL capability envisioned for 2012, Department of Defense must develop a production model approach to ADL development that enables rapid generation and dissemination of tailorable and effective instruction.

The analysis identified four key research areas that address the educational design process from requirements analysis and course development to delivery and assessment. Focused research in these four areas is necessary to achieve the “*ADL in 2012*” vision.

- **Intelligent Computer-Aided Instruction (ICAI).** ICAI focuses on the development of an empirical foundation for how individuals and teams develop expertise to guide the selection of ADL instructional alternatives and provide an accurate assessment to enable appropriate follow-on, remedial instruction, and system improvement.
- **Authoring Tools (AT).** This examines the development of tools to quickly and appropriately retrieve and effectively teach digitally coded knowledge and skills.
- **Distributed Simulations (DS).** Distributed simulations look at the problem of generating realistically performing models of individual behavior, virtual team members, adversaries, friendly forces, and non-combatants in a realistic environment across the ADL network.
- **Dynamic Learning Management (DLM).** DLM addresses the infrastructure and architecture needed to ensure ADL interoperability and security.

Figure 9 represents the critical path items that require immediate additional attention to realize the vision of “*ADL in 2012.*”

**Figure 9. “ADL in 2012” Key Research Areas**

<b>Description</b>	<b>Goals</b>	<b>Research Issues</b>
<p><b><u>Assessment</u></b></p> <p>Methods for automatically generating unobtrusive, near-real-time assessment techniques</p>	<p>Develop a comprehensive model linking learner behaviors with learning and outcomes</p> <p>Increase efficiency and validity of assessment generation</p> <p>Tailor assessment generation to individuals and teams</p> <p>Develop cumulative measures of relevant experience</p>	<p>How can comprehensive models and measures of individual and team capabilities and performance be generated?</p> <p>How can valid, unobtrusive near-real-time assessment be developed from learner interactions with the learning?</p> <p>How do we model individual training and experience histories to predict the ease of learning and retention of needed task-specific knowledge and skills?</p> <p>What techniques can we develop for assessing cognitive workload and strategies for mitigating adverse effects of workload?</p>
<p><b><u>Cognitive Theory</u></b></p> <p>Understand higher-order cognitive skill development: decision-making, problem-solving, teamwork, metacognition, pattern recognition, critical thinking, and situational awareness</p>	<p>Create principles of distributed instruction based on established models of learning and skill acquisition</p> <p>Develop ADL instructional alternatives built on understanding how individual and team expertise develop</p>	<p>How does expertise evolve in complex, ill-structured environments?</p> <p>What is the role/significance of flexible/adaptive learning in promoting better problem solving and critical thinking?</p> <p>What is the role of cognitive workload in individual, group, and team learning?</p>

## **Advanced Distributed Learning (ADL) Seeks to Provide the Warfighter with On-Demand Training and Education.**

The addition of ADL capabilities to traditional Armed Forces education and training programs provides powerful new tools to establish, improve, and maintain the skills of American soldiers, sailors, airmen, and marines. The emergence of networking and computer technologies enables easier access to distributed education and training resources. ADL empowers “learner centric” education and training, marking a shift from the current classroom and distance teaching philosophy to a model of anytime, anywhere learning. Formal instruction is becoming more effective and less restricted to classroom settings and training events as service personnel access expanding ADL-compliant content on-demand around the world.

## **Training and Education are Central Components of Developing Cognitive Readiness in Support of *Joint Vision 2010***

The DUSD (S&T) is supporting research initiatives to advance the development of ADL as part of its focus on Cognitive Readiness. ADL-based education and training are the first of several factors being examined by DUSD (S&T) (See Figure 8). Cognitive Readiness underscores the importance of the human dimension in war and the understanding that advances in cognitive performance may become a revolutionary war-winning capability. Enhanced mental preparation assumes greater importance in the high-tempo warfare envisioned in *Joint Vision 2010*. The ability to gain and use information superiority is critical to shaping and reacting to events on the battlefield and ensuring decision dominance.

## **Study Objective: Identify Key Components for a Research Agenda for Achieving a Robust ADL capability by 2012**

This assessment identifies opportunities for DUSD (S&T) to invest in basic, applied, and advanced technology development research in the areas of learning technology, cognitive science, and related fields that will accelerate, direct, and extend the impact of ADL on the military instructional system through 2012.

## **ADL Research Front-End Assessment**

A front-end assessment of existing S&T efforts related to ADL was conducted to identify currently funded research as well as to begin to determine the research required enabling optimal implementation of ADL. The study’s approach consisted of interviews with subject matter-experts in psychology, computer science, artificial intelligence, modeling and simulation, education, and related areas. These experts identified relevant studies and projects for review, provided background, and served as a resource throughout the study. Independent Internet and literature searches were performed to gain an overview of industry, academic, and government ADL research efforts. This included a focused review

of Department of Defense S&T funding relevant to education and training to establish a baseline of current ADL-related research.

### **Defining the Evolving Military Requirement for Training and Education**

Joint Vision 2010 envisions an increasingly lethal battlefield in which commanders can target and kill key enemy assets in real time using satellite-based surveillance systems, precision guided munitions, and computer-based mission planning systems. The frenetic pace of this emerging “hyperwar” is generating increased pressure on commanders and their staffs as they look to keep pace with the explosion of information and the need for rapid decision making (Hoffman, 1994). The ability to collect, analyze, fuse, and disseminate information at the appropriate pace and sequence will separate the victors from the vanquished on an increasingly transparent battlefield.

The U.S. doctrine of maneuver warfare attempts to address the chaos of the battlefield by devolving decision making authority to lower levels closer to the point of decision. This approach places a premium on the ability to act and to react to events more quickly than an opponent can respond. Emerging from this fluid environment is the notion of the “strategic corporal” whose actions may increasingly affect the outcome of single engagements and even entire campaigns (Krulak, 1999). The decision to strafe a suspected Serb motor column during the Kosovo campaign and the resulting political fallout from the civilian casualties inflicted in the attack demonstrate the impact of decisions made by lower ranking personnel and their potential consequences.

### **Service Personnel Must be Capable of Penetrating the Fog of War**

The notion of the strategic corporal challenges long-held assumptions regarding the development of the prototypical individual required for battlefield success. The ongoing Revolution in Military Affairs suggests a need for a shift in focus in military training and education from relatively rudimentary skills associated with specific techniques and procedures to higher order cognitive skills involving collaboration, reflection, and articulation. The ability to seamlessly conduct operations, ranging from military operations other than war to general warfare, requires flexible and adaptable personnel. As *Joint Vision 2010* captures, “People are the Armed Forces; at the end of the day, our success, in war or in peace, will rest ultimately on the men and women of the Armed Forces.” (*Joint Vision 2010*, 1996)

### **Real-World Constraints Impact the Services’ Ability to Train and Educate**

A number of factors ranging from competition for recruits to the evolving security environment threaten to outpace the military’s ability to provide comprehensive military education and training. Current and forecast trends in military recruiting point to a shortage of qualified candidates for the services. With increasing numbers of possible applicants choosing civilian careers, the Army, Air Force, and Navy are facing a recruitment gap that a federal advisory commission identified as a potential future military threat (Myers,

1999). The statistics on retention of experienced personnel are no more encouraging. With the exception of the Marine Corps, all the services failed to meet their retention goals for fiscal year 1999. The Air Force's struggle to keep experienced pilots typifies the problem of maintaining key military occupations at authorized strength. In addition, decisions made to keep experienced service men and women during the early 1990s draw down are being felt as this group approaches retirement age (Tracey, 1999). The high operational tempo and personnel turnover of today's military results in reduced training and educational opportunities. Students are geographically separated and have limited time to receive necessary instruction. For example, service personnel stationed in the Persian Gulf enforcing the sanctions against Iraq, are unavailable to attend stateside schools and training. Finally, competition for dollars to achieve desired levels of readiness and force modernization leads to fewer resources for training and education.

### **ADL Provides a Means for Efficient and Effective Continued Learning for the Total Force**

The ADL initiative grew out of the Department of Defense strategy to "harness the power of learning and information technologies to modernize education and training" (DUSD (R), 1999). ADL reflects Secretary of Defense William Cohen's vision of ensuring "that Department of Defense personnel have access to the highest quality education and training that can be tailored to their needs and delivered cost effectively, anytime and anywhere." This initiative capitalizes on emerging network technologies to tie together distributed instructional resources, including intelligent tutors, subject-matter experts, and traditional instruction to support "learner-centric" education on a continuing basis.

### **Current ADL is in The Prototype Stage of Development**

The initial implementation of ADL is yielding promising results, but the concept has still not received widespread implementation. The reason, in part, is that the development of ADL courseware is in the "prototype stage," requiring experts to design and implement instructional programs. Scientifically valid principles for course design and commercial-off-the-shelf software for authoring are not yet available to support journeyman development of ADL material. Lack of standards regarding content format and underlying technology infrastructure further complicate ADL implementation. To significantly impact military training and education, ADL must develop a production model approach to development that enables rapid generation of tailorable and effective instruction.

### **DUSD (S&T) Established 2012 as the Target Date for Realizing the Promise of ADL**



DUSD (S&T) vision for ADL outlined below describes functional characteristics needed to enable robust cognitive capabilities. “*ADL in 2012*” will support the Total Force and contains six features:

- **Accessibility:** access instructional components from one remote location and deliver them to many other locations,
- **Interoperability:** use instructional components developed in one location with one set of tools or platform in another location with a different set of tools or platform,
- **Adaptability:** tailor instruction to individual and situational needs,
- **Reusability:** incorporate instructional components into multiple applications,
- **Durability:** operate instructional components when base technology changes, without redesign or recoding,
- **Affordability:** increase learning effectiveness significantly while reducing time and costs.

#### **“*ADL in 2012*” Characteristics**

“*ADL in 2012*” will be a collaborative, affordable and adaptive instructional environment for the Department of Defense education and training. The environment will be interoperable, open and evolutionary, with a ubiquitous, distributed, standards-based infrastructure. “*ADL in 2012*” will have an integrated toolset to permit intelligent design guidance, continuous task analysis, learning and field performance assessment and feedback, cognitive task analysis, insertion and modification of practice components, and automatic upgrades of training and performance support content and strategies. Adaptable to characteristics of learners and teams, “*ADL in 2012*” will account for aptitude, diversity and culture, incoming skills and knowledge, and provide training and performance support anytime and anywhere for Department of Defense missions. Individuals and teams will be supported by a system that promotes development of competencies such as collaboration, problem solving, analysis, evaluation, reasoning, critical thinking, and decision making. They will be supported by an instructor and peer-based dynamic mentoring environment. “*ADL in 2012*” will be sustainable through a policy and institutional environment that adapts to fully support and embrace this vision.

(ADL S&T Workshop 1999)

## **5.0 Implementation Issues and Potential Barriers**

**5.1 Education and Training Institutions.** The department’s education and training institutions may need incentives to aid and accelerate the move from traditional instruction toward advanced distributed learning where appropriate. Given the need to continue high-quality education and training during the transition, these institutions will

have to choose between allocating funds to ADL and preserving their existing capabilities.

**5.2 Collaboration Incentives.** Incentives may also be needed to stimulate collaborative development and sharing of advanced distributed learning resources across the components and across the public and private sectors.

**5.3 Resources.** Lacking existing programs and resources for advanced distributed learning, Department of Defense agencies and the Unified Commands may need special assistance in launching their respective ADL initiatives.

**5.4 Faculties.** The faculties of the various schools are the Subject-Matter Experts (SMEs) upon whom Department of Defense must depend for content development, validation, updating and delivery. Department of Defense should consider the benefits and costs associated with permitting faculty members to obtain intellectual property rights associated with ADL courseware that they develop.

**5.5 Policies.** Since ADL is a new learning paradigm that brings instruction to the individual wherever and whenever needed, the department should consider adopting policies and programs that permit military and civilian personnel to learn at the desktop PC, at installation computer labs, or electronic classrooms without risk of learning interruption.

**5.6 Access.** Successful implementation of ADL across the department will require all Department of Defense members to have unfettered access to ADL tools and courseware whenever, and wherever they are needed. Transitioning to this new learning paradigm may require the department to consider new policies that help defray the cost of tools and basic Internet access for all Department of Defense members, regardless of where stationed or how serving.

**5.7 Information Security.** Information security and privacy should allow, rather than impede, advanced distributed learning. While information security and the protection of the department's information networks are of high importance, careful attention will be needed to ensure that security policies do not restrict access to advanced distributed learning materials.

**5.8 Interoperable Learning Management System** A significant amount of formal instruction is required for skills upgrade, career progression, and promotion. The student management and mastery of learning is a critical element for these mandatory courses. Some courses are part of accredited degree-granting programs. These programs, and the institutions that offer them, must meet certain standards in areas such as institutional effectiveness, educational support, and administrative processes. These requirements and standards drive the need for a robust learning management system with the capabilities for assessment, student records, and instructional support, among other requirements. Conversion of mandatory and accredited courses in the short term may be

hampered by a lack of progress in the LMS area. An ADL architecture for delivery and management of courses needs to be developed.

**5.9 Legislative.** Congressional assistance may be required to gain relief from United States Code, Title 37 (Pay and Allowances of the Uniformed Services) § 206 (Reserves; members of National Guard: inactive - duty training) (d) which states: “This section does not authorize compensation for work or study by a member of a reserve component in connection with correspondence courses of an armed force.” To our knowledge there is no definition of correspondence courses offered in U.S. Code. Webster’s dictionary defines correspondence courses as “a course offered by a correspondence school.” Advances in learning technologies now allow Reserve Component members the ability to be trained, be educated, be mentored and learn “anytime, anywhere.” Even with an up-to-date interpretation of Title 37 § 206 (d) that does not define DL as correspondence courses, this law needs to be changed to allow for compensation for correspondence courses that are part of any required training or education. Course authors need to be able to address the full toolbox of media, and Title 37 § 206 (d) limits that flexibility. Today, however, there is no "liberal" interpretation of the statute; so many within the financial management community define DL as equal to a correspondence course and, therefore, compensation for its completion by any Reserve Component member is not allowed.

**6.0 Future Implementation Activities and Goals.** There have been, as discussed earlier, a number of significant department-wide implementing actions since the department published its Strategic Plan for Advanced Distributed Learning in April 1999. The department will accelerate the process.

**Future Implementing Activities.** Department of Defense’s current focus is to work through its Education and Training Steering Committee to set scheduling goals for the next two years for converting courses, as identified by the components, in accordance with the ADL SCORM. In parallel we will continue to seek the support of key leaders throughout the department to assist in adopting and mandating key and challenging transformational actions as we create the future learning environment -- one that is learner-centric and where knowledge is available anywhere, anytime. An essential element of this process will be the continuing development of specific ADL learning prototypes to demonstrate the efficiency and effectiveness of advanced distributed learning in achieving the Secretary’s vision. The department will be making planned improvements to the SCORM, facilitating its adoption by the appropriate international standards-granting organizations as a standard, and assisting its incorporation into commercial products. The ADL Co-Laboratories will play an essential role, by helping others incorporate ADL compliance into the design of course content and by assessing the costs and benefits of ADL-compliant prototypes.

### **Key Implementing Goals and Milestones**

#### **Spring to Winter 2000**

- Conduct a series of “plugfest” events to test, validate, and refine the SCORM

- Complete development of SCORM compliance-testing software
- Encourage collaborative development across the Department of Defense, academia, and the private sector through active involvement in the ADL Co-Labs
- Encourage voluntary compliance with SCORM in course development
- Encourage vendors to incorporate SCORM V1.0 into their next product cycle
- Release Version 2.0 in early Fall 2000
- Work with standards groups for SCORM adoption
- Staff a plan for joint distributed training architectures
- Complete ADL rapid prototype development

#### **Winter 2001**

- Assess whether there should be an acquisition policy decision for mandatory compliance with SCORM

#### **Winter 2008**

- All existing courses slated for conversion are SCORM-compliant

#### **Winter 2010**

- Joint Vision 2010 goal of achieving “information superiority” is enabled through an ADL capability of providing the right information and knowledge anywhere, anytime

**The Big Picture -- ADL in Context.** The ADL Initiative is the Department of Defense’s principal vehicle for developing a broad range of plans and programs that use advanced communications and learning technologies to modernize how we will educate and train U.S. armed forces.

As mentioned at the outset, ADL’s primary goal is to implement the Secretary of Defense’s training vision -- to provide access to the highest quality education and training that can be tailored to individual needs and delivered cost-effectively, anytime and anywhere. The underpinnings of ADL are germane to other government organizations, academia, and the private sector as well. As such, the department has designed the ADL Initiative to be a collaborative effort between the public and private sectors to develop the common standards, tools, and learning content that are critical to the future learning environment.

Advanced technologies are changing how people live their lives and do business -- not just how they learn. Moreover, the pace of technological change is expected to remain extremely rapid for the foreseeable future. This presents a challenge to the department as it strives to apply learning technologies cost-effectively. While we have made enormous progress in a short period of time, we are committed to accelerating that progress.

If we are to rely heavily on networked communications, we must ensure security and protect personal privacy. If learning objects are to be shared, reused, and marketed, we must protect intellectual property rights. If we are to take full advantage of such

technologies, we must fundamentally change how we do business; and this means we must change organizational structures, reengineer budget processes, and provide incentives to enable and motivate change.

The department recognizes that the power to learn (through education, training, and performance support) is critical to making U.S. service members and armed forces ready to carry out their missions. This “Department of Defense Implementation Plan for Advanced Distributed Learning” reflects the department’s commitment to building the learning environment of the future.

## Appendix 1

### Program Investment

#### **Defense Planning Guidance for FY 2002-2007 will assist the department in maintaining visibility of investments in advanced distributed learning implementation:**

Secretary of Defense directed the Department of Defense components to ensure that U.S. forces have access to the highest-quality training and education, tailored to their needs and delivered cost effectively, anytime, and anywhere—to maintain the readiness and capabilities needed to respond to the dynamic global threat environment in JV 2010.

**Strategic Training Plans.** Department of Defense components will work with the Office of the Under Secretary of Defense for Personnel and Readiness (OUSDP&R) to develop and maintain strategic training plans that guide Department of Defense training programs and demonstrate how they take full advantage of learning technologies, simulation technologies, embedded training, and instrumentation systems. These plans will focus on delivering training anytime, anywhere.

**Advanced Distributed Learning Initiative.** Department of Defense components will identify and annually report in their POMs, in specific distributed learning program elements, all distributed learning programs and resources (including research and development). Distributed learning programs will conform to the Department of Defense common specification for sharable course content [the SCORM] in order to achieve interoperability, reuse, and cost efficiency. To optimize joint training readiness and reduce OPTEMPO, the department must increase use of ADL techniques for the training of joint and coalition forces. United States Commander-in-Chief, Joint Forces Command (USCINCFJCOM), as the department's lead for Distributed Joint Training, shall aggressively pursue efforts to develop and implement ADL in order to meet current and future training needs of the CINCs and services.

**Distributed Education and Training Coalition Network.** Development of coalition-based global educational and training opportunities through advanced distributed learning shall be explored and implemented wherever deemed feasible and cost-effective. To increase engagement with foreign militaries, improve interoperability between them and U.S. forces, and enhance regional security, regional Commanders-in-Chief (CINCs) will examine the feasibility of establishing a distributed education and training data services network. In accordance with the Unified Command Plan of 1999 (UCP-99), U.S. Joint Forces Command (JFCOM) will support this effort by leading the development and operation of systems and architectures that directly support the distributed joint training requirements of other CINCs, joint task forces (JTFs), and defense agencies. In defining their distributed joint training requirements, regional CINCs shall include education, training, and exercise requirements in support of the Theater Engagement Plans.

#### **Component Investment in ADL from the Data Call:**

**Conversion of Existing Content to ADL Media (Hours)**

	<i>FY00</i>	<i>FY01</i>	<i>FY02</i>	<i>FY03</i>	<i>FY04</i>	<i>FY05</i>	<i>TOTAL</i>
<b>AIR FORCE</b>	203	142	386	384	354	72	1,541
<b>ARMY</b>	3,045	2,042	3,978	4,926	5,030	5,892	24,913
<b>NGB/PEC</b>	620	812	990	807	807	807	4,843
<b>NAVY</b>	0	282	243	227	47	0	799
<b>USMC</b>	189	200	200	200	200	150	1,139
<b>TOTAL</b>	4,057	3,478	5,797	6,544	6,438	6,921	33,235

**Conversion of Existing Content to ADL Media (Millions of Dollars)**

	<i>FY00</i>	<i>FY01</i>	<i>FY02</i>	<i>FY03</i>	<i>FY04</i>	<i>FY05</i>	<i>TOTAL</i>
<b>AIR FORCE</b>	1.650	0.766	6.500	5.190	3.110	0.660	17.876
<b>ARMY</b>	20.902	22.651	24.778	28.411	31.074	28.062	155.878
<b>NGB/PEC</b>	9.300	12.180	14.850	12.105	12.105	12.105	72.645
<b>NAVY</b>	0.000	3.387	2.923	2.726	0.568	0.00	9.604
<b>USMC</b>	2.775	3.100	3.100	3.500	3.500	3.000	18.975
<b>TOTAL</b>	34.627	42.084	52.151	51.932	50.357	43.827	274.978

**Delivery of ADL Media (Hours)**

	<i>FY00</i>	<i>FY01</i>	<i>FY02</i>	<i>FY03</i>	<i>FY04</i>	<i>FY05</i>	<i>TOTAL</i>
<b>AIR FORCE</b>	118	321	463	849	1,233	1,587	4,571
<b>ARMY</b>	195	3,045	2,042	3,978	4,926	5,030	19,216
<b>NGB/PEC</b>	928	2,320	3,480	4,060	4,640	5,220	20,648
<b>NAVY</b>	167	322	328	334	341	313	1,805
<b>USMC</b>	165	290	396	521	379	587	2,338
<b>TOTAL</b>	1,573	6,298	6,709	9,742	11,519	12,737	48,578

**Cost of Delivery of ADL Media (Millions of Dollars)**

	<i>FY00</i>	<i>FY01</i>	<i>FY02</i>	<i>FY03</i>	<i>FY04</i>	<i>FY05</i>	<i>TOTAL</i>
<b>AIR FORCE</b>	2.842	1.573	4.786	2.391	2.533	2.587	16.712
<b>ARMY</b>	75.878	70.955	67.430	64.270	70.838	82.824	432.195
<b>NGB/PEC</b>	0.050	0.150	0.400	0.750	1.000	1.700	4.050
<b>NAVY</b>	3.080	3.860	3.937	4.015	4.095	3.760	22.747
<b>USMC</b>	2.400	4.400	6.000	7.300	5.700	8.300	34.100
<b>TOTAL</b>	84.250	80.938	82.553	78.726	84.166	99.171	509.804

## Appendix 2

### Component Course Conversion Projection

**Army Courses scheduled for conversion to partially or wholly technology-based delivery FY2000-2010:**

67G (C-23) FE Qual/Transition	AC TO RC Orientation Course	Accounting Specialist	ADA C4I Tactical Oper CTR ENH
ADA Officer Advanced (Patriot Follow-on)	Adjutant General Officer Advanced	Administrative Law CLE Overview	Administrative Specialist ANCOC
Administrative Specialist BNCOC	Administrative Warrant Officer Advanced	Advanced FA Tactical Data System	Advanced Fraud Investigation
Advanced Management Accounting and Analysis	Aeromedical Evacuation Officer CRS	AFATDS Command And Staff	AH-1 Attack Helicopter Repair
AH-64 Armament/Electrical Sys Rpr Supv ANCOC	AH-64 Armt/Electrical Systems Rpr Supv BNCOC	AH-64 Attack Helicopter Repairer	AH-64 Attack Helicopter Repairer Supv BNCOC
AH-64 A Armament/Electrical Systems Repairer	Air Defense Artillery ANCOC	Air Defense Artillery BNCOC	Air Defense Artillery Officer Advanced
Air Defense Artillery Pre-Command	Air Traffic Control Operator ANCOC	Air Traffic Control Operator BNCOC	Aircraft Component Repairer Supervisor ANCOC
Aircraft Electrician Repairer Supv BNCOC	Aircraft Maintenance ANCOC	Aircraft Pneudraulics Repairer Supv BNCOC	Aircraft Powerplant Repairer
Aircraft Powerplant Repairer Supv BNCOC	Aircraft Powertrain Repairer	Aircraft Powertrain Repairer Supervisor BNCOC	Aircraft Structural Repairer
Aircraft Structural Repairer Supervisor BNCOC	Airdrop Load Inspector Certification	Allied Trades Technician WO Advanced	AMEDD Advanced Nurse Leadership
AMEDD Head Nurse Leader Development 6F-F3	AMEDD NCO Advanced (NCOES) 6F-F2	AMEDD NCO Basic (NCOES)	AMEDD NCO Basic (NCOES) 6-8-40 76J30
AMEDD NCO Basic (NCOES) 91P30	AMEDD NCO Basic (NCOES) 91A30	AMEDD NCO Basic (NCOES) 91R30	AMEDD NCO Basic (NCOES) 91X30
AMEDD NCO Basic	AMEDD NCO Basic	AMEDD NCO Basic	AMEDD NCO Basic



(NCOES) 91S30	(NCOES) 91D30	(NCOES) 91E30	(NCOES) 91Q30
AMEDD NCO Basic (NCOES) 91M30	AMEDD NCO Basic (NCOES) 71G30	AMEDD NCO Basic (NCOES) 91T30	AMEDD NCO BASIC (NCOES) 91V30
AMEDD NCO BASIC (NCOES) 42E30	AMEDD NCO BASIC (NCOES) 91C30	Ammunition Specialist BNCOC	AMEDD Officer Advanced
Ammunition Specialist (Multi Phased Course)	Ammunition Specialist ANCOC	Antiterrorism Instructor Qual	Ammunition Technician WO Advanced
Animal Care Specialist	Annual JAG's CLE Training Program	Armament Repairer Supervisor BNCOC	Apprentice CID Special Agent
Armament Repair Technician WO Advanced	Armament Repairer	Automated Fire Spt Sys Specialist ANCOC	Armor Officer Advanced
Army Accident Investigation Course	Atc Systems, Subsystems & Equip	Automatic Test Equipment Operator	Automated Logistical Management ANCOC
Automated Logistical Management BNCOC	Automated Logistical Specialist	Aviation Maintenance Manager	Avenger Crewmember
Avenger System Repairer	Aviation Life Support Equipment Technician	Aviation Operations Specialist BNCOC	Aviation Officer Advanced
Aviation Operations Specialist	Aviation Operations Specialist ANCOC	Avionic Mechanic	Aviation Safety Officer
Aviation WO Advanced	Avionic Maintenance Supervisor ANCOC	Battle Staff Noncommissioned Officer	Avionic Mechanic BNCOC
Basic Environmental Staff	Basic Morse Code	Bradley Fighting Vehicle Sys Turret Mechanic	Blood Donor Center Operations
Bradley Fighting Vehicle Leader	Bradley Fighting Vehicle Sys Mechanic BNCOC	Bridge Crewmember BNCOC	Bradley Inf Fighting Veh Sys Master Gunner
Bradley Linebacker Crewmember	Bridge Crewman	Cardiovascular Specialty (Multi Phased Course)	Budget Training
Cable Systems Installer/Maintainer	Cable Systems Installer-Maintainer BNCOC	Cargo Specialist BNCOC	Career Management Field 91 BNCOC (Course Is Not In ATRRS)
Cargo Specialist	Cargo Specialist ANCOC	CBT Documentation/Production Spec BNCOC	Carpentry/Masonry Specialist*
Cavalry Scout ANCOC	Cavalry Scout BNCOC	Chaplain Assistant BNCOC	CH-47 Helicopter Repairer
CH-47 Helicopter Repairer Supervisor	Chaplain Assistant	Chemical Officer Advanced	Chaplain Assistant Supervisor ANCOC

BNCOC			
Chaplain Officer Advanced	Chemical ANCOC	Civil Affairs Officer	Chemical Operations Spec BNCOC (Reclass)
Chemical Operations Specialist BNCOC	CID Warrant Officer Advanced	Civil Affairs Specialist-RC	Civil Affairs Operations
Civil Affairs Specialist ANCOC	Civil Affairs Specialist BNCOC	Combat Engineer BNCOC	Combat Casualty Care
Combat Engineer	Combat Engineer ANCOC	Command and Control Systems In	Combating Terrorism on Military Installations
Combined Arms & Services Staff School (CAS3)	Combined Logistics Officer Advanced (Multi Phased Course)	Concrete and Asphalt Equipment Operator	Command And General Staff Officer Preparatory
Common Aviation Mgmt Trk (67) BNCOC	Communications Security Tech WO Advanced	Construction Equipment Supervisor BNCOC	Construction Contract Admin
Construction Engineering Supervisor BNCOC	Construction Equip Repairer Supervisor BNCOC	Conventional Phys Security/Crime Prevention	Contract Attorneys Course
Contract Law CLE Overview	Contracting Officer Representative	Counter Intelligence Officer (AST-35E)	Corrections Specialist
Counterintelligence Agent	Counterintelligence Agent BNCOC	Data Processing Technician WO Advanced	Criminal Law CLE Overview
Criminal Law New Developments Course	Data Processing ANCOC	Dental Specialist	Defense Packaging Data Systems
Dental Lab Specialty	Dental Spec ANCOC Course Not Listed in ATRRS)	Dragon Gunner	Disbursing Operations
DoD Pest Management	DoD Strategic Debriefing	Electronics Maintenance Chief ANCOC	Ear, Nose & Throat (ENT) Specialty (Multi Phased Course)
Elec Systems Maintenance Tech WO Advanced	Electrical--QV	Executive Administrative Assistant	Engineer Equipment Repair Tech WO Advanced
Engineer Equipment Repairer	Engineer Officer Advanced Course	Faculty Development (FDC/FDCC)	Eye Specialty (Multi Phased Course)
FA Meteorological Senior Sergeant ANCOC	Fabric Repair Specialist	Field Artillery Officer Advanced Course	Family Advo Staff Tng (ADV) (FASTA)
Family Advocacy Staff Tng (Fast)	Federal Labor Relations Course	Fighting Vehicle Infantryman BNCOC	Field Operations
Fighting Vehicle Infantryman	Fighting Vehicle Infantryman ANCOC	Finance/Accounting BNCOC	Finance Officer Advanced Course
Finance Specialist	Finance/Accounting	Food Service Specialist	Fire Control Systems

	ANCOC		Repairer
First Sergeant	Food Service Spec ANCOC (Course Not Listed In ATRRS)	Force Protection Unit Advisors	Food Service Specialist ANCOC
Food Service Specialist BNCOC	Food Service Technician WO Advanced	Ground Surveillance Systems Operator	Fuel and Electrical Systems Repairer
General Construction Equipment Operator	General Engineer ANCOC	Heavy Antiarmor Weapons Infantryman BNCOC	Ground Surveillance Systems Operator BNCOC
Heavy Antiarmor Weapons Infantryman	Heavy Antiarmor Weapons Infantryman ANCOC	Hlth Svc Human Resources Mgr (HRM)	Heavy Construction Equipment Operator
Heavy Wheel Vehicle Mechanic	HIMAD DS/GS Maintenance Tech WO Advanced	Imagery Intelligence Officer (Ast 35C)	Hosp Food Svc Specialist (Basic)
Imagery Analyst	Imagery Analyst BNCOC	Individual Terrorism Awareness	Indirect Fire Infantryman
Indirect Fire Infantryman ANCOC	Indirect Fire Infantryman BNCOC	Infantryman	Infantry Mortar Leader
Infantry Officer Advanced	Infantry Pre-Command	Information System Operator-Analyst BNCOC	Infantryman ANCOC
Infantryman BNCOC	Infantryman BNCOC CMF	Intel/EW Equipment Technician WO Basic	Information Systems Operator-Analyst
Instructor Training Crs (ITC)	Integrated Family Test Equipment	Interior Electrician	Intelligence Analyst
Intelligence Analyst BNCOC	Intelligence In Combatting Terrorism	Joint Personal Property	International Law Cle Overview
Interrogator	Interrogator BNCOC	Laundry & Shower/Fabric Repair Spec ANCOC	Joint Psychological Operations
Land Combat Elec Missile Sys Repair	Land Combat Support System Test	Legal Assistance	Laundry & Shower/Fabric Repair Spec BNCOC
Legal Specialist	Light Wheel Vehicle Mechanic	M1 Abrams Tank Systems Mechanic	Logistics Management Development
Long Range Surveillance Leader	M1 Abrams Tank System Mechanic BNCOC	M1/M1A1 Tank Commander Cert (Transition)	M1/M1A1 Abrams Armor Crewman
M1/M1A1 Abrams Armor Crewman BNCOC	M1/M1A1 Abrams Master Gunner	M2/3 Bradley Fighting Vehicle System Mechanic	M109A6 (Paladin) Commander
M1A1 Abrams Tank Turret Mechanic	M1A2 Tank Commander Certification	Man-Portable Air Defense System Crewmember	M3 Bradley/CFV Cavalry Scout

Machinist	Management Development Course	Materiel Acquisition Management	Marine Warrant Officer Advanced
Master Fitness Trainer-RC	Materiel Acquisition Management	Medical Equipment Repairer ANCOC (Course Not Listed In ATRRS)	Mechanical--QV
Med Mgt Chem/Biological Casualties	Medical Equip Repairer (Unit Level)	Medical NCO ANCOC (Course Not Listed in ATRRS)	Medical Laboratory Spec (Course Not Listed In ATRRS)
Medical Laboratory Spec (MLT)(IET)	Medical Logistics Management (Cor)	Mental Health Spec ANCOC (Course Not Listed in ATRRS)	Medical Specialist
Medical Supply Spec ANCOC (Course Not Listed In ATRRS)	Medical Supply Specialist	Microwave Systems Operator/Maintainer	Mental Health Specialist (MHS)
Metal Worker	Metal worker BNCOC	Military Intelligence Officer Advanced	Microwave Systems Operator/Maintainer BNCOC
Military Intelligence ANCOC	Military Intelligence Officer (T)	Military Police ANCOC	Military Intelligence WO Advanced
Military Physician Assistant	Military Police	Mlrs Fire Direction Senior Sergeant ANCOC	Military Police BNCOC
Military Police Officer Advanced	Military Stnd Trans & Movement Procedures	Motor Transport Operator BNCOC	Mortuary Affairs Specialist
Motor Transport Operator	Motor Transport Operator ANCOC	Nat'l Environmental Policy Act Implementation	Multichannel Transmission Sys Opr/Maint BNCOC
Multichannel Transmission Systems Op-Main	Multiple Launch Rocket System	Noncommunications Interceptor/Analyst	NBC Defense Officer/NCO Course
Ordnance ANCOC	Orthopedic Spec.(Multi Phase)	Patient Admin ANCOC (Not in ATRRS)	Operational Law Seminar
Patriot Fire Control Operator	Patriot Launching Station Enhanced Oper/Maint	Patriot System Technican WO Basic	Patient Admin Specialist
Performance Management For Safety (Course Not Listed In ATRRS)	Personnel Administration Specialist	Personnel Information System Mgt Specialist	Performance Management For Safety (Course Not Listed In ATRRS)
Personnel Services Specialist	Petroleum And Water Specialist ANCOC	Petroleum Laboratory Specialist	Personnel Services Sergeant BNCOC
Petroleum Officer	Petroleum Supply Specialist	Petroleum Supply Specialist BNCOC	Petroleum Laboratory Specialist BNCOC
Pharmacy Sterile	Pharmacy Spec	Pharmacy Specialist	Petroleum Vehicle

Products Specialty (Y7)	ANCOC (Course Not Listed In ATRRS)		Operator
Plumber/Utilities Man (51K10)	Postal Operations	Power Generation Equipment Repairer	Physical Therapy Specialty (Multi Phased Course)
Practical Nurse	Practical Nurse	Practical Nurse ANCOC	Power-Generation Equipment Repairer BNCOC
Presentation Techniques For ORSA	Preventive Dentistry Specialty	Preventive Medicine Spec ANCOC	Pre-Hosp Trauma Life Support
Prin Of Military Prev Medicine	Property Accounting Technician WO Advanced	Psychological Operations ANCOC	Preventive Medicine Specialist
Psychological Operations Officer	Psychological Operations Specialist	Quarrying Specialist	Psychological Operations BNCOC
Radio Operator-Maintainer	Radio Opr/Maintainer BNCOC	Radio Repairer (Transition)	Quartermaster/Chemical Equipment Repairer
Record Telecommunications Operator-Maintainer	Regional Studies	Respiratory Specialist (Multi Phased Course)	Radiology Specialist (Multi Phased Course)
Satellite/Microwave Systems Chief ANCOC	School Of The Cadet Command	Scout Platoon Leader	Rough Terrain Container Handling & Operation
Self-Propelled FA System Mechanic	Self-Propelled FA System Mechanic BNCOC	Self-Propelled FA Turret Mechanic	Security Assistance Team Trng & Orientation
Senior Officer Logistic MGT.	Sr. Personnel Svc Sergeant ANCOC	Sere High Risk (Level C)	Senior Off Legal Orient Course
SF Detachment Officer Qualific	Signal Intel/Elect Warfare Officer (AST-35G)	Signal Officer Advanced	Sex Trans/Other Commun Disease Intervention
Signal Support Systems Specialist BNCOC	Signal Support Systems Supervisor ANCOC	Signals Intelligence Analyst BNCOC	Signal Support Systems Specialist
Small Group Instruction Training	Small Unit Leaders Force Protection	Sniper	Small Arms/Towed Artillery Repairer
Special Forces Combat Diver QU	Special Forces Combat Diving S	Special Forces Communications	Spec Opns Communications Systems Specialist
Special Forces Diving Medical	Special Forces Engineer Sergeant	Special Forces Medical Sergeant	Special Forces Communications

			Sergeant ANCOC
Special Forces Technician WO Advanced	Special Forces Technician WO Basic	Special Forces Weapons Sergeant	Special Forces Medical Sergeant ANCOC
Special Operations Target Inte	Special Operations Training	Standard Army Retail Sup Sys 2AD/2AC/2B	Special Operations Communication
Supervisor Development	Supply and Service Management Officer	Supply Systems Technician WO Advanced	Standard Army Training System
Systems Approach To Tng for Mgrs	Tac Officer Training And Orientation Course	Tactical Automated Network Tech WO Advanced	Support/Staff Maintenance Tech WO Advanced
Target Acquisition Radar Technician WO Basic	TATS Administrative Specialist	TATS Air Traffic Control Operator (Transition	Target Acquisition Radar Tech WO Advanced
TATS Automated Fire Control Section SGT BNCOC	TATS Automated Fire Support Sys Specialist	TATS Cannon Fire Direction Sec Chief BNCOC	TATS Armor Crewman ANCOC (Multi Phased Course)
TATS Command & General Staff Officer Course	TATS FA Cannon Platoon Sergeant ANCOC	TATS FA Cannon Section Chief BNCOC	TATS Cannon Fire Direction Specialist
TATS FA Meteorological Section Sergeant BNCOC	TATS FA Senior Radar/Targeting Sergeant ANCOC	TATS FA Survey Senior Sergeant ANCOC	TATS FA Firefinder Radar Operator
TATS Field Artillery Meteorological Crewmember	TATS Field Artillery Radar Sect. Chief BNCOC	TATS Field Artillery Surveyor	TATS FA Surveyor Section Chief BNCOC
TATS Fire Support Sergeant BNCOC	TATS Fire Support Specialist	TATS MET Equip Maint - Met Data System	TATS Fire Support Sergeant ANCOC
TATS MLRS Fire Direction Specialist	TATS MLRS Opns/Fire Direction Sec Chief BNCOC	Technical Engineering Specialist	TATS MLRS Fire Direction Specialist
Telecommunications Computer Opr/Maint BNCOC	Telecommunications Computer Opr/Maintainer	Telecommunications Operations Chief ANCOC	Technical Engineering Supervisor BNCOC
Tow Master Gunner	Track & Wheel Veh Recovery Specialist	Track Vehicle Mechanic	Telecommunications Operator-Maintainer BNCOC
Track Vehicle Repairer BNCOC	Traffic Management Coordinator	Traffic Management Coordinator ANCOC	Track Vehicle Repairer
Training Developer (Middle Manager)	Travel Administration and Entitlements	Turbine Engine Driven Generator Repairer	Traffic Management Coordinator BNCOC
UH-1 Helicopter Repairer Supervisor BNCOC	UH-60 Helicopter Repairer (Transition)	UH-60 Helicopter Repairer Supervisor BNCOC	UH-1 Helicopter Repairer

Unit Movement Officer Deployment Planning	Unit NBC Defense Officer/NCO Refresher	Unit Supply Specialist	Unit Maintenance Tech (Heavy) WO Advanced
Unit Supply Specialist BNCOC	Utilities Equipment Repairer	Utilities Equipment Repairer BNCOC	Unit Supply Specialist ANCOC
Veterinary Food Insp SP (Basic)	Voice Intercept Technician WO Basic	Voice Interceptor BNCOC	Veterinary Food Insp ANCOC
Water Treatment Specialist	Water Treatment Specialist BNCOC	Watercraft Engineer	Warrant Officer Staff
Watercraft Operator ANCOC	Watercraft Operator BNCOC	Wheel Vehicle Repairer	Watercraft Operator
X-Ray Spec ANCOC	Wire Systems Equip Repairer BNCOC		

**Navy Courses scheduled for conversion to partially or wholly technology-based delivery (FY00-FY01, Additional courses for the remainder of the FYDP will be provided in the next addition of the plan.):**

2M Insp Requal	ABH Refr Amphib	Afloat HAZMAT Coord	Aflt Env Pro Crd
Air Traffic Control Managers Course	ALRE CATS	ALRE CATS REFR	ALRE QA ADMIN
Ammo Admin	ASB SUP/WKR	ASB SUP/WKR REF	Avionics Corrosion Control
Basic Corrosion Control	Bw/Fw/Nonprop Certification	CCC	Command Financial Specialist Training
EPA Ref Certification	Flight Deck Safety	Force Protection Officer	Gas Free Engineering
Hazard Waste Ops Emerg Response	Joint Maritime Operations (3 Modules)	Joint Maritime Operations (3 Modules)	Joint Qual Assurance Insp
Joint Qual Assurance Off/Supv	LSSO CAT II	Military Customs Inspection	Mishap Investigation (Ashore)
MSP Rec Keep Sem	NAVOSH Ashore	NICNAC	Nuc Inst Quals
Pilot Adv Nav	Resp Protect Off	Safe Trng Methods	Safe Prog Afloat
SAFR	SAGS	SHOBS AG/OPTLDAD	SHPBD Asbestos
Snap 3-M Systems Coordinator/Inspector	Sub ATM Sup Main	Submarine Saf of	Task Based Curriculum Developer
TORPRM Supervisor	Weekend Supply & SNAP2 Refresh		

**Marine Corps Courses scheduled for conversion to partially or wholly technology-based delivery:**

0171 MISSO Analyst Course	Command & Staff College - 8801	Command & Staff College - 8802	Command & Staff College - 8803
Command & Staff College - 8804	Command & Staff College - 8805	CYZ - 10 Data Transfer Device	Fin Mgmt Officer's Course - Comptroller
Fin Mgmt Officer's Course - Finance	Fire Support Coordination Course	Fundamentals Of Diesel Engines	HAZMAT
Incidental Motor Vehicle Operator	Land Navigation	Landmine Warfare	M16 Rifle Sustainment
Marine Armor NCO Program	Personal Financial Management	Prc - 113 UHF Radio Set	Sb-3865 Tactical Digital Switchboard
Senior Clerks Course	Sergeants Enlisted PME	Status Of Resource Training Systems (SORTS)	Terrorism Awareness
Wire Fundamentals			

**Air Force Courses scheduled for conversion to partially or wholly technology-based delivery:**

Deployed Air Reserve Components Ops and Law Crs	ACSC - Resident - Operational Forces	Command & Control Craftsman	Traffic Management Craftsman
AF Senior NCO Academy	ACSC - Resident - War Theory	Manpower and Organization Mgt Craftsman	Communication-Electronics Craftsman
Airman Leadership School	ACSC - Resident - Joint Ops and Campaign Concepts	Education and Training Craftsman	Status of Operational Resources (SORTS) (USAF)
HAZMAT Mgt Program 99A	First Sgt Academy Add'l Duty Symposium	Vehicle Operations Craftsman	Avionics Advanced Workcenter Management Course
Teaming for Production Mgt	Contingency Warplanning Course (CWC)	Information Security Managers (new course)	Civil Engineer Craftsman Course
Information Warfare Applications	AF On-Scene Commanders Course (on site)	Services Craftsman	Technical Writer Principles



Squadron Officers School – Resident * - inc 3.5 ITV	Teaming Environment for Acquisition Managers * - inc. 2.8 hrs ITV	Air Traffic Control Operations Craftsman	Aircraft Electrical & Environmental Systems Craftsman
Reserve Forces Judge Advocate Course	Fundamentals of Data Management	Technical Writer (Non Resident)	Security Forces Craftsman (CDC)
Mortuary Affairs Course	Air National Guard Annual Survey of the Law	Basic Security Forces Officer's Course	Internet/HTML Familiarization
GCCS/UNIX  Acquisition Excellence	PCE - Chaplain  AF On-Scene Commander's Course – Resident * - inc. 2.8 hrs ITV	Activity Manager Pavements Maintenance, Inspection, and Repair	Fuels Craftsman  Command Post Craftsman
ACSC - Resident - Nature of War	Airfield Management Craftsman *-inc. 39 hrs ITV	Basic Instructor Course	Aircraft Hydraulics Systems Craftsman
ACSC - Resident - Aerospace Operations	Vehicle Maintenance Craftsman	Personnel Craftsman	Instructional System Designer
ACSC - Resident - Conflict Resolution	Pest Management Recertification (J3ABR3E453-002)	Cargo Movement Operations System	Supply Management Craftsman
ACSC - Resident - Leadership and Command Course	Pest Management Recertification (J4ART3E453-000)	MANPER-B Systems Course	Training Supervisor
Advanced Logistics Officer Course	Pest Management Certification	F-15 Aircraft Maintenance Craftsman	Computer Based Instructional Designer * - inc. 29.5 hrs ITV
Quality Assurance - Aircraft (ACC)	Aircraft Maintenance Craftsman (Heavy)	Operations Resource Management Craftsman	Advanced Communications-Computer Systems Planning & Implementation Mgmt Specialist
Air Transportation Craftsman * - inc. 44.25 ITV	Munitions System Craftsman	Advanced Security Forces Officer Symposium	
Security Forces Superintendent	Aerospace Propulsion	Aerospace Ground Equipment	C-130 Self-Contained

Symposium	Craftsman	Craftsman	Navigation System
TEMPEST Fundamentals	F-16 Aircraft Maintenance Craftsman	Aircraft Armament System Craftsman	Jet Engine Mishap Investigation
TRG/Ed Cntr Maintenance and Sustainment	Joint Doctrine Air Campaign Course (JDAC)		

**National Guard Bureau (PEC) Courses scheduled for conversion to partially or wholly technology-based delivery:**

79T Basic Course	Army Performance Improvement (APIC)	ARNG 79T ANCO	ARNG Marketing NCO
ARNG MEPS Guidance Counselor	ARNG Recruiting & Retention Management	ARNG Retirement Counselor	ARNG Senior Enlisted Management
ARNG Unit Attrition Management	Aviation Material Management Course - FY99	Battalion Supply	Consultant Course
DEF (REF) Pack of HAZMAT	DEF Pack of HAZMAT for Transport	Distance Learning Instructor Training Course - FY99	Engagement Skills Trainer Operator - FY99
Facilitator Course	Maintenance Management	Master Marksmanship Trainer Course	MOBCON Basic
NG Scout Sniper	Officer in Charge (OIC)	OMS / UTES - Technician - FY99	OMS/UTES/MATES Basic Suprv & Tech Course
Performance Measurements & Practical Applications - FY99	Personnel Officer	Personnel Sergeant	Petroleum Operator Course
Practitioner Course	SAAS-MOD BLK-1B (TDA Fielding)	SAAS-MOD BLK-1B (TO&E Fielding)	SAAS-SUST
SAMS-1 / REHOST	SAMS-2 / REHOST	SARSS1 Operator Course	SARSS1 Supervisor Course
SARSS-1(O) NDI / UNIX Training - FY99	SARSS-2AC/B (O) Material Manager Course	SARSS2AC/B I-SQL Course	SARSS2AC/B Supervisor Course
SARSS2AC/B Workshop	Senior Food Service Management	Small Arms Firing School	Small Arms Instructor/Range Operations (SAIROC)
SMM Budget	SMM Support	SPBS-R Advanced (PBO Advanced)	SPBS-R Basic (PBO Basic)
SR OMS/UTES SUP	Standard Army	State Marksmanship	Strategic Planners

	Training System (SATS-4.0)	Coordinators	Course
Subsistence Technician	Training/Readiness/Mobilization	ULLS-A PC/QC/TECH Supply Functional - FY99	ULLS-A System Support/ULLS-A Administrator - FY99
ULLS-G System Support Course	ULLS-S4 Operator / Supervisor Training	Unit Clerk	Unit Supply

**U.S. Joint Forces Command.** The Fiscal Year 2000 plan for the development of the USJFCOM Joint Distributed learning Center goals and milestones has been approved by the Commander of USJFCOM's Joint Warfighting Center, and it is being implemented. However, the level of effort is not fully robust due to fiscal constraints. FY-00 efforts have been funded through the Joint Staff's CINCs' Initiative Funds. Further developmental efforts for the out-years are being planned, although funding has not been confirmed. The following milestones outline approved FY-00 course conversions. Planned course conversions are provided for FY-01 and beyond. The plans will be subject to change based on operator/user input and requirements.

- Document JDLC processes and methodologies
- Complete development of twelve web-based "handbook" revisions for JTF Commander and Staff topics
- Complete development of eight new web-based "handbooks" for JTF Commander and Staff topics
- Complete development of six "videos" on JTF Commander and Staff topics
- Complete two media-rich interactive courseware modules
- Complete development of web-based job aids and instructional materials
- Research, review and post relevant references/links to other web sites
- Deploy the JDLC on the NIPRNET and SIPRNET

Starting in FY-01 and ending in FY-05 the Joint Distributed Learning Center will:

- Complete development of entire spectrum of web-based products that offer "fully robust" functional topics for JTF Commander and Staff training
- Complete development of entire spectrum of web-based products that offer "fully robust" functional topics for CINC Battle Staff training
- Complete development of entire spectrum of web-based products that offer "fully robust" functional topics for JTF Commander and Staff training involving NATO/PfP forces
- Incorporate "intelligent search engine" technology
- Incorporate "user profiling" technology
- Incorporate video "streaming" technology
- Enable more robust and "user friendly" database access
- Incorporate a Learning Management System (LMS)
- Develop additional job aids/additional links/references/instructional materials
- Maintain, update, and improve the JDLC

## **Appendix 3**

### **Sharable Courseware Object Reference Model (SCORM)**

*(Note: extracted from formal SCORM document with associated document format numbering system--full SCORM is available for download at <http://www.adlnet.org>)*

#### **The Need for A Reference Model**

Successful implementation of this initiative will require issuance of guidelines that are shared and observed by organizations with a stake in the development and use of instructional technology materials. The ultimate form and status of these guidelines remain to be determined. They may be international or national standards, agreed upon practices, recommendations, or de facto practices.

If these guidelines are to be successfully articulated and implemented they must be based on a common “reference model.” This model will not replace the detailed models of instructional system design or practice that have been devised and adopted by specific organizations such as those of instructional developers, instructional tool developers, or customers associated with particular industries or the Armed Forces. Instead, the purpose of the reference model is to describe an approach to developing instructional material in

sufficient detail to permit guidelines for the production of sharable courseware objects to be clearly articulated and implemented.

### **Reference Model Criteria**

There are three primary criteria for such a sharable courseware objects reference model. First, as stated above, it must fully support articulation of guidelines that can be understood and implemented for the production of sharable courseware objects. Second, it must be adopted, understood, and used as much as possible by as wide a variety of stakeholders, such as courseware and courseware tool developers and their customers. Third, it must permit mapping of any stakeholder's specific model for instructional systems design and development into itself. Stakeholders must be able to see how their own model of instructional system design is reflected by the reference model they hold in common.

Applications of information technology have been shown to increase both the effectiveness and efficiency of training. However, up-front investment is required to develop and convert training materials for technology-based presentation. These investment costs may be reduced by an estimated 50-80 percent through the use of sharable courseware "objects" that are:

1. Durable – do not require modification as versions of system software change.
2. Interoperable – operates across a wide variety of hardware, operating systems, and web browsers.
3. Accessible – can be indexed and found as needed.
4. Reusable – can be modified and used by many different development tools.

Procedures for developing such courseware objects are within the state-of-the-art, but they must be articulated, accepted, and widely used as guidelines by developers and their customers. These goals can only be achieved through collaborative development. Collaboration will also increase the number, quality, and per unit value of courseware objects made available. Such collaboration requires agreement upon a common reference model.

### **SCO Reference Model**

This section provides a high level overview of the scope and purpose of the SCORM. Subsequent sections define technical details for implementing each aspect of the model.

### **Defining "Learning Management Systems"**

Learning Management System (LMS) is used as a catchall term throughout this document. It refers to a suite of functionalities designed to deliver, track, report on, and administer learning content, student progress, and student interactions. The term LMS can apply to very simple course management systems, or highly complex enterprise-wide distributed environments.

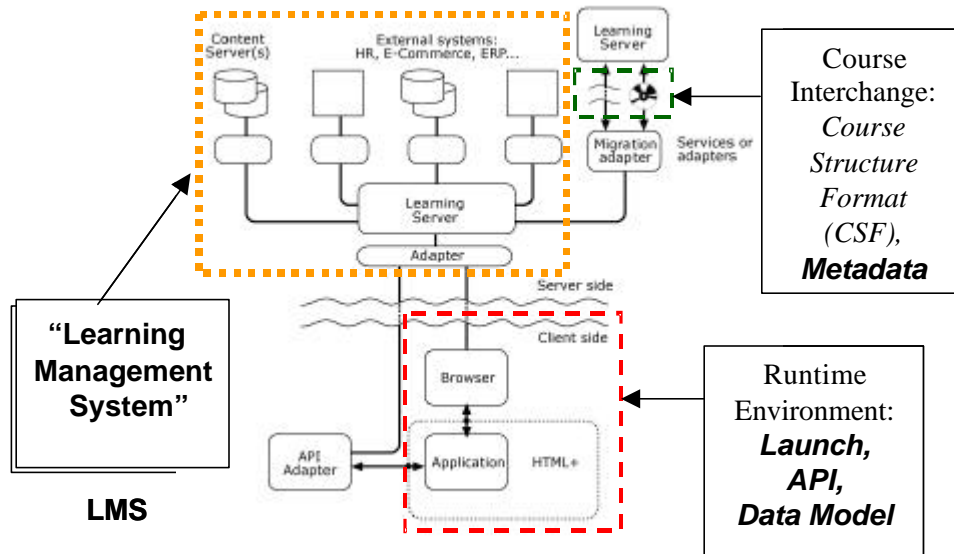

Figure 3.1a – Broad definition of “Learning Management System” (LMS) as a suite of server-side functionalities that controls the delivery and tracking of learning content to a client-side student. The SCORM does not specify functionality within the LMS. Only Course Interchange, Metadata, and Runtime Environment are “in scope” for this version of SCORM.

Many participants in the development of learning technology standards now use the term LMS instead of “Computer Managed Instruction” (CMI) so as to include new functionalities and capabilities that have not historically been associated with CMI systems such as back-end connections to other information systems, complex tracking and reporting, centralized registration, on-line collaboration, adaptive content delivery.

The term LMS is now being used as a “superset” description of many possible capabilities. Within the SCORM content, implementations are expected to vary widely. SCORM focuses on key interface points between content and LMS environments and is silent about the capabilities provided within a particular LMS.

Within the SCORM context, the term LMS implies a server-based environment in which the intelligence resides for controlling the delivery of learning content to students. In other words, in the SCO reference model, the LMS has the “smarts” about what to deliver and when, and tracks student progress through the learning content.

Learning content, therefore, has no “management” role in the SCORM since that function is entirely within the LMS. That means that SCORM content does not determine (on its own on the client-side) how to navigate through a course or when a student has completed a

section of the course; that's the LMS's job. This approach frees content from course-specific constraints and permits content to be developed that is reusable, sharable, and as context independent as possible.

## **Overview of SCO Reference Model**

The SCORM defines a web-based learning “content model.” At its simplest, it is a set of interrelated specifications designed to meet Department of Defense's high level requirements for web-based learning content reusability, accessibility, durability, and interoperability.

The work of the ADL Initiative to develop the SCORM is also a process to knit together disparate groups and interests. It is hoped that this reference model will be a bridge from general emerging technologies to commercial implementations.

A number of organizations have been working on different but highly related aspects of web-based learning technology. These work areas have coalesced into three major topics: metadata, run time environment, and course interchange. While these evolving areas have made great strides recently, they have not been “connected” to one another in a meaningful way. In some cases emerging specifications are quite general, anticipating a wide variety of implementations by various user communities (e.g., metadata), in others the specifications are rooted in earlier Computer Managed Instruction (CMI) practices and require adaptation to web-based applications.

It is the purpose of the SCORM to apply current technology developments – from groups such as the Instructional Management Systems (IMS) Project, the Airline Industry CBT Committee (AICC), and the Institute of Electrical and Electronic Engineers (IEEE) Learning Technology Standards Committee (LTSC) – to a specific content model and to produce recommendations for consistent implementations by the vendor community. The scope of the SCORM is not all-inclusive. There are a host of issues that are not addressed by this version of the document. It is expected that the scope will be enlarged over time and the reference model will be expanded as experience is gained through implementation and deployment.

This version of the SCO reference model comprises three major elements:

**1. Course Structure Format:** An Extensible Markup Language (XML)-based representation of a course structure that can be used to define all of the course elements, structure and external references necessary to move a course from one LMS environment to another (*Section 5 of this document*).

**2. Run Time Environment:** A definition of Run Time Environment that includes a specific launch protocol to initiate executable web-based content, a common content-to-LMS application program interface (API), and a data model defining the data that is exchanged between an LMS environment and executable content at run-time (*Section 6 of this document*).

3. **Metadata:** A mapping and recommended usage of IEEE LTSC Metadata elements for each of the following SCORM categories (*Section 7 of this document*):

- **Course Metadata:** A definition for external metadata that describes a course package for the purposes of searching (enabling discoverability) within a courseware repository, and to provide descriptive information about the course.
- **Content Metadata:** A definition of metadata that can be applied to web-based content “chunks” that provides descriptive information about the content independent of a particular course. This metadata is used to facilitate reuse and discoverability of such content within, for example, a content repository.
- **Raw Media Metadata:** A definition of metadata that can be applied to so-called “raw media” assets such as illustrations, documents, or media streams that provides descriptive information about the raw media independent of courseware content. This metadata is used to facilitate reuse and discoverability *principally during content creation* of such media elements within, for example, a media repository.

### **High Level Requirements and SCORM Scope**

The SCORM document frequently references the following high level ADL requirements throughout this document. The definitions below describe the capabilities that the SCORM expects to enable:

- **Accessibility:** the ability to access instructional components from one remote location and deliver them to many other locations
- **Interoperability:** the ability to use instructional components developed in one location with one set of tools or platform in another location with a different set of tools or platform (note: there are multiple levels of interoperability)
- **Durability:** instructional components that do not require redesign or re-coding to operate when base technology changes
- **Reusability:** the design of instructional components so that it can be incorporated into multiple applications

These can be restated as:

- The ability of a web-based LMS to launch “executable” content authored using tools from different vendors and to exchange data with that content.
- The ability of web-based LMS products from different vendors to launch the same executable content and exchange data with that content during execution.



- The ability of multiple web-based LMS products/environments to access a common repository of executable content and to launch such content.

During the initial implementation and testing phases, these requirement statements will be used as evaluation criteria.

### Web-based Design Assumption

The SCORM assumes an Internet, web-based infrastructure as a basis for its technical implementation. This assumption was made for several reasons:

- Web/Internet technologies and infrastructure are rapidly expanding and provide a mainstream basis for learning technologies
- Web-based learning technologies standards do not yet exist
- Web-based content can be delivered using nearly any medium (e.g., CD-ROM, stand-alone systems, and/or as networked environments)

This approach embraces the main stream transition to common content and delivery formats that is occurring in industry. Computer operating system environments now natively support web content formats such as HTML, JPEG. The trend is toward the use of common content formats that can be used locally, on local intranets, or over the Internet. The SCORM extends this trend to learning technologies.

**Figure 4a – ADL SCO Reference Model Diagram**

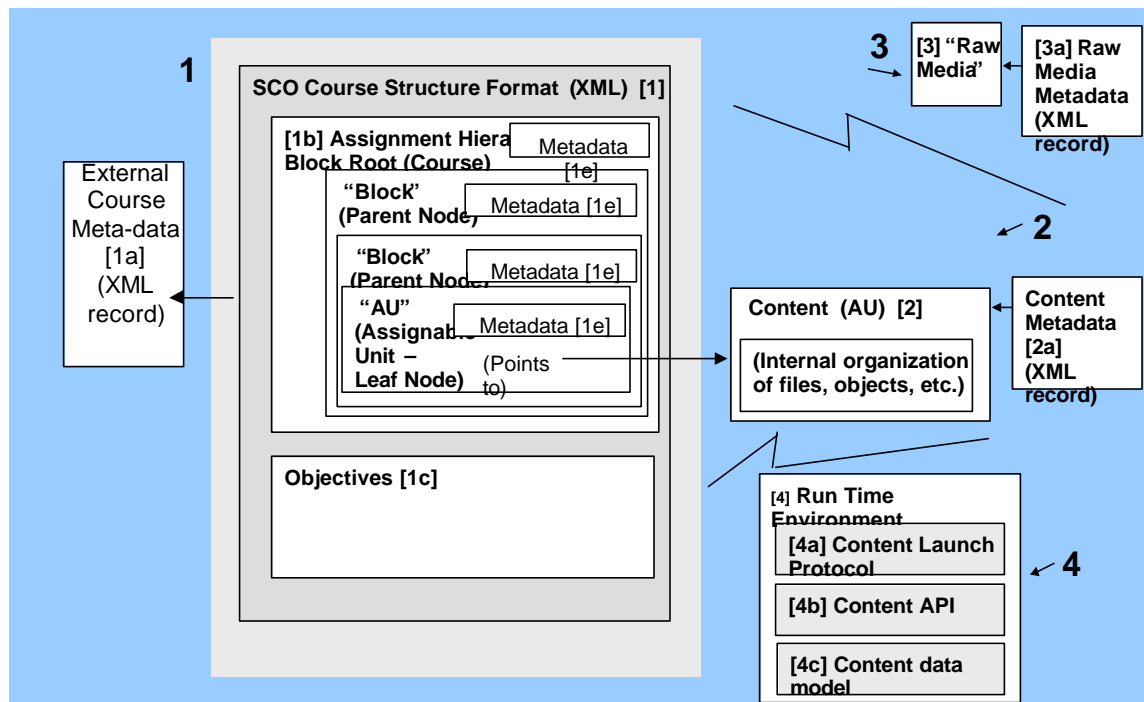

## **Definitions**

### **4.1 Sharable Courseware Object**

An interoperable, durable computer-based course or component of a course packaged with sufficient information to be reusable and accessible.

### **4.2 Sharable Courseware Object Reference Model**

A software model that defines the interrelationship of course components, data models, and protocols such that courseware “objects” are sharable across systems that conform to the same model.

### **4.3 Course Structure Format [1]**

A Course Structure Format (CSF) defines all of the course elements, the course structure, and all external references necessary to represent a course and its intended behavior.

#### **4.3.1 External Course Metadata [1a]**

Information that can be searched externally such as the course title, course description, and version.

#### **4.3.2 Assignment Hierarchy [1b]**

A tree structure that defines a hierarchical lesson plan for a course. The ordering of the tree elements defines a default sequence for the execution of each of the assignments in the course.

#### **4.3.3 Objectives [1c]**

A statement of skills, knowledge, and attitudes to be acquired by the student.

#### **4.3.5 Assignment Hierarchy Metadata [1e]**

Metadata that is described with the specific assignments at different levels within the lesson plan hierarchy. Course element metadata within a particular course hierarchy that is context specific to that course hierarchy.

## **Content [2]**

Content that runs on a client. Content that is executed within a client-side browser.

#### **4.4.1 Content Metadata [2a]**

Metadata that describes a [sharable] “chunk” of content. Content metadata is not related to a specific course structure (i.e., context independent metadata).

Information that can be searched externally such as content asset title, description, and version.

## **Raw Media [3]**

Media assets such as images, sounds, text, or other presentation documents that may be incorporated into executable assets (content) during authoring or dynamically at runtime.

Media assets have metadata but are not expected to be used standalone (i.e., outside of content).

### **Raw Media Metadata [3a]**

Metadata that describes raw media elements in a non-context specific way. Information that can be searched externally such as media asset title, description, date of creation, and version. Information that can be used to create a searchable repository of sharable media elements.

### **Run Time Environment [4]**

Defined mechanisms for starting (launching) executable content and exchanging data between an LMS and the content.

#### Content Launch Protocol [4a]

Protocol used to launch the executable content and connect it to the Application Program Interface (API) provided by an LMS.

#### Content Application Program Interface [4b]

API used by the content to communicate with an LMS.

#### Content Data Model [4c]

Definition of the data exchanged between an LMS and the content launched under control of such a system:

The LMS makes student data available to the content. The content passes learner performance data and other tracking information back to the LMS.

## **Appendix 4**

### **Joint Advanced Distributed Learning Network Architecture**

#### **Implementing the Joint Advanced Distributed Learning Network**

##### **Purpose**

This appendix outlines the plan of action for developing and implementing the Joint ADL Network. This effort will be led by U.S. Joint Forces Command, in coordination with the Under Secretary of Defense for Personnel and Readiness (USD(P&R)), the lead for the department's Advanced Distributed Learning (ADL) Initiative, and the Joint Staff, on behalf of the Chairman of the Joint Chiefs of Staff, the lead for Joint Professional Military Education and Training.

##### **Overview**

U.S. Joint Forces Command, as the Lead Agent for distributed joint training is responsible for developing the Joint Advanced Distributed Learning Network. This effort will include collecting and integrating operational and functional requirements and the development of network design alternatives that will facilitate joint professional military education, joint and coalition training. This training will be available on a global, anytime, anywhere basis. Recent advances in research in advanced distributed learning technologies and practices will be leveraged. All systems and capabilities will be based on open standards and architectures in full compliance with the Joint Technical Architecture and the Defense

Information Infrastructure/Common Operating Environment (DII/COE). Overarching roles include:

- U.S. Joint Forces Command – JFCOM will coordinate, consolidate, and maintain worldwide joint training support requirements and transform those requirements into an end-to-end global network. This will include defining operational requirements in coordination with users and developing appropriate operational and technical architectures. U.S. Joint Forces Command will coordinate the requirements and development process through the Department of Defense Education and Training Steering Committee and the Joint Requirement Oversight Council (JROC).
- The DUSD(R) – As the Secretary’s designated lead for ADL, will ensure that the Joint ADL Network complies with ADL policy and strategy for developing and implementing advanced distributed learning technologies across the department, and will coordinate with the services, USD(A&T), and the Comptroller to plan for sufficient programs and resources. The DUSD(R) also chairs the Department of Defense Education and Training Steering Committee, and as such, will coordinate Joint ADL Network periodic program reviews.
- The OSD (C3I) – As the Department of Defense C4ISR architect, OSD (C3I) will provide oversight of the overall network integration process in order to ensure compliance with Department of Defense architecture guidance. The Defense Information Services Agency (DISA) will support the establishment of networks and communications connectivity as required by the operational requirements and in accordance with the joint technical architecture.
- CINCs and services – Will work with U.S. Joint Forces Command and the Joint Staff by documenting Joint ADL Network operational and functional requirements and identifying required training and educational nodes. U.S. Joint Forces Command will work closely with the CINCs to ensure proposed Joint ADL Network solutions meet theater specific needs.

The U.S. Joint Forces Command has established FY 03 as the Initial Operational Capability (IOC) and FY 06 as the Final Operational Capability (FOC) of the Joint ADL Network. A detailed plan of action is provided below.

**Implementation Plan by Fiscal Year**

**FY 00 – Planning and Preparation:**

<b>Item #</b>	<b>Description</b>	<b>OPR</b>
00-01	Continue the Joint Warfighting Capabilities Assessment process	USJFCOM
00-02	Collect and integrate operational and functional requirements	CINCs, Services
00-02a	Conduct a CINC conference focused on requirements	Joint Staff, USJFCOM, CINCs

<b>Item #</b>	<b>Description</b>	<b>OPR</b>
	for a coalition-based information network.	
00-02b	Conduct surveys and visits with the regional and functional CINCs.	USJFCOM
00-02c	Conduct an ADL Stakeholder conference focused on the requirements of the Services.	USJFCOM
00-02d	Conduct an ADL Stakeholder conference focused on the requirements of the regional and functional CINCs.	USJFCOM
00-02e	Conduct an ADL Stakeholder conference focused on the requirements of government agencies.	USJFCOM
00-03	Develop the Joint ADL Network Operational Architecture	USJFCOM
00-04	Draft the Joint ADL Network Concept of Operations	USJFCOM
00-05	Draft the JWFC ADL Campaign Plan	USJFCOM
00-06	Submit proposed FY-01 ADL ACTD	USJFCOM
00-07	Collect and analyze cost data	USJFCOM
00-08	Begin cataloguing and assessing existing data services networks	USJFCOM
00-09	Coordinate the Joint ADL Network with the Global Information Grid Capstone Requirements Document	USJFCOM
00-10	Develop the Joint ADL Network Technical Architecture	USJFCOM
00-11	Complete the Joint ADL Network Mission Needs Statement	USJFCOM
00-12	Schedule FY01 (and beyond) ADL demonstrations	USJFCOM
00-13	Work with the ADL Co-Laboratory to ensure compliance ADL specifications and guidelines	USJFCOM
00-14	Conduct ADL demonstrations	USJFCOM
00-15	Plan FY-01 & FY-02 ADL demonstrations	USJFCOM
00-16	Conduct site surveys for Type III, VI, and VII Joint ADL Network sites	USJFCOM
00-17	Complete development of Joint ADL Network Joint Information Exchange Requirements (JIERS)	USJFCOM

**FY 01 – Initial Development Work:**

<b>Item #</b>	<b>Description</b>	<b>OPR</b>
01-01	Continue cataloguing and assessing existing data service networks	USJFCOM
01-02	Catalogue existing DoD, federal, NATO and P&P distributed learning content/courses	IDA, P&R, Services, USJFCOM
01-03	Collaboratively develop end to end ADL learning process from content and indexing, to course to full syllabus in support of the ADL Learning Management System	IDA, P&R, Services, USJFCOM

<b>Item #</b>	<b>Description</b>	<b>OPR</b>
01-04	Develop and build ADL meta-catalogue of distributed learning content	IDA, P&R, Services, USJFCOM
01-05	Establish the Joint ADL Network testbed	USJFCOM
01-06	Complete the JWCA assessment process	USJFCOM
01-07	Catalogue and validate specific Type I, II, IV, and V Joint ADL Network sites.	USJFCOM, CINCs, Services
01-08	Complete the Joint ADL Network Operational Requirements Document	USJFCOM
01-09	Participate in FY-01 IDA Co-Lab assessments	USJFCOM
01-10	Conduct Joint ADL Network (testbed) system interoperability testing	USJFCOM
01-11	Plan FY-03 ADL demonstrations	USJFCOM
01-12	Conduct ACTD	USJFCOM
01-13	Conduct ADL demonstrations	USJFCOM
01-14	Complete and validate Joint ADL Network JIERs	USJFCOM

**FY 02 – Demonstration and Certification:**

<b>Item #</b>	<b>Description</b>	<b>OPR</b>
02-01	Establish JSIMS/JTASC connectivity	USJFCOM, Joint Staff
02-02	Conduct Joint ADL Network technical architecture assessment	USJFCOM
02-03	Conduct Joint ADL Network operational architecture assessment	USJFCOM
02-04	Continue FY-02 Joint ADL Network (Testbed) System Interoperability testing	USJFCOM
02-05	Continue FY-02 ADL Co-Lab Assessments	USJFCOM
02-06	Conduct FY-02 ADL demonstrations	USJFCOM
02-07	Plan FY-03 ADL demonstrations	USJFCOM
02-08	Schedule FY-04 ADL demonstrations	USJFCOM

**FY 03 – Initial Operational Capability (IOC):**

<b>Item #</b>	<b>Description</b>	<b>OPR</b>
03-01	Joint ADL Network certified to support basic functionality	USJFCOM
03-02	Joint ADL Network portal certified to be fully functional with content repositories linked via meta-catalogue indexes to LMS systems	USJFCOM
03-03	Continue FY-03 Co-Lab assessments	USJFCOM
03-04	Continue FY-03 Joint ADL Network testbed interoperability testing	USJFCOM
03-05	Conclude Demonstration Phase of the ADL ACTD	USJFCOM
03-06	Conduct FY-03 ADL demonstrations	USJFCOM

<b>Item #</b>	<b>Description</b>	<b>OPR</b>
03-07	Plan FY-04 ADL demonstrations	USJFCOM
03-08	Schedule FY-05 ADL demonstrations	USJFCOM
03-09	Transition ADL ACTDs to acquisition and fielding	USJFCOM

**FY 04 – Expansion and Certification:**

<b>Item #</b>	<b>Description</b>	<b>OPR</b>
04-01	Continue Joint ADL Network system interoperability testing	USJFCOM
04-02	Continue Co-Lab Assessments	USJFCOM
04-03	Conduct FY-04 ADL demonstrations	USJFCOM
04-04	Plan FY-05 ADL demonstrations	USJFCOM
04-05	Schedule FY-06 ADL demonstrations	USJFCOM

**FY 05 – Expansion and Certification (continued):**

<b>Item #</b>	<b>Description</b>	<b>OPR</b>
05-01	Continue Joint ADL Network system interoperability testing	USJFCOM
05-02	Continue ADL Co-Lab Assessments	USJFCOM
05-03	Conduct FY-05 ADL demonstrations	USJFCOM
05-04	Plan FY-06 ADL demonstrations	USJFCOM

**FY 06 – Final Operational Capability (FOC):**

<b>Item #</b>	<b>Description</b>	<b>OPR</b>
06-01	Joint ADL Network certified to support all required functionality	USJFCOM
06-02	Continue FY-06 Co-Lab assessments	USJFCOM
06-03	Continue FY-06 Joint ADL Network system interoperability testing	USJFCOM
06-04	Conduct FY-06 ADL demonstrations	USJFCOM

**Emerging Design Issues**

Several fundamental design issues have surfaced as the Joint ADL Network Development Program evolved. The security, scalability, accessibility, availability, usability, adaptability, affordability, and performance of the network are important considerations in the development program.



*Security* is a primary concern for the Joint ADL Network. The potential for unauthorized access and malicious mobile code presents a real challenge in a network of this kind. Thus, the Joint ADL Network will use firewalls and other security technologies where appropriate, to keep the network secure. Effective integration of multinational and interagency participants in the training audience is another problem that must be solved. Therefore, new multi-level network security solutions will be considered as a way to enable coalition training.

*Scalability*, or how well the solution to a problem will work when the size of the problem increases, is another key issue. Considering the potential for training audiences to increase considerably from event to event, the Joint ADL Network must be able to accommodate additional data sources or increases in data bandwidth. As such, no software changes and minimal system modifications shall be required.

*Accessibility* of high quality learning content is a fundamental requirement of the Secretary's ADL Vision and Strategy and is key to achieving the Information Superiority (and knowledge superiority) goals the JV2010. This includes a capability to "reach back" to education and training resources within Department of Defense, the federal agencies, academia, the private sector, or in some cases, to foreign allies. *Accessibility* also includes the capability to deliver high quality learning content to Department of Defense personnel anytime and anywhere.

*Availability* of information is critical to an effective training program. Models and other systems must be available to the training audience, with limited unscheduled downtime occurring, to ensure an efficient training experience. Thus, the Joint ADL Network must be capable of providing the required bandwidth and distribution, making data accessible from any required location, including sites outside any existing infrastructure. Since distributed learning must be accessible anytime and anywhere, sufficient "on-call" bandwidth will be available on this network.

The Joint ADL Network must provide a high degree of *usability*. It must use web-based technology to provide a common look and feel and enable ease of use. An off-the-shelf approach to setting up a distributed joint training event will enhance the usability of the system, enabling audiences to focus on the training event itself. It also must provide features that enhance the learning process, such as a searchable index of data and the capability to store and retrieve all posted training reports and assessments that have been released.

The Joint ADL Network must offer *adaptability* as well. It must use an open-standards-based architecture to promote interoperability among all required applications and databases and to comply with DII COE guidelines. It must follow a modular development process to allow step-wise growth and updating. Applications should be independent of the hardware platform so that current investment in hardware can be replaced during normal attrition. It must have a level of expandability that accommodates use by service components for service training if required in the future.

The Joint ADL Network must offer *affordability* to ensure future program success. It must improve the efficiencies of all categories of training, education, and related missions through reusability of applications, infrastructure services, and content, and must provide cost-effectiveness per net increment of time. A minimum development effort for the network will be required, and existing resources will be leveraged whenever possible to reduce program costs. More cost-effective distribution of joint training will be achieved through less costly communication links, reducing setup labor costs and recurring link costs through economies of scale. The focus will be on cost savings of the network rather than the cost of commercial leased lines.

Finally, *network performance* must be considered, including the accuracy, efficiency, and complete throughput of information. The transfer of information must be seamless and efficient, providing for as real a training experience as possible. Network management must not interfere with the training exercise itself. Downtime must be kept to a minimum.

The Joint ADL Network will facilitate several capabilities, including—

- Collaboratively scheduling and planning exercises;
- Rehearsing missions;
- Distributing simulations and exercise control;
- Sharing training data and analyzing lessons learned;
- Providing distributed learning;
- Providing global skills training (e.g., GCCS operators);
- Developing tactics, techniques, and procedures;
- Developing and testing joint doctrine; and
- Providing training opportunities for allies and partners.

The Joint ADL Network focuses on the use of remote approaches to train geographically distributed people by leveraging information superiority. It directly supports JV2010 goals for the creation of a simulation superhighway, connecting forces globally to facilitate high quality, realistic, and stressful training in support of each CINC.

## Appendix 5

### Joint Professional Military Education

Chairman of the Joint Chiefs of Staff Professional Military Education (PME) Vision:

“The PME system of the 21<sup>st</sup> Century will consist of a mix of service-specific and joint education that is seamless, offering educational opportunities at all stages of the military officer’s career. While a major purpose of the system will be to develop joint warfighters and strategists, it will also afford important military education for many other officers, for carefully selected civilians, and for international military fellows.” CJCSI 1800.01, 1 March 1996, Officer Professional Military Education.

In February 1998, the Director of the Joint Staff (DJS) directed J-7 to review JPME and to develop a course of action (COA) that might improve the JPME process. The purpose of the study was to define JPME requirements and identify an educational process system that will prepare officers for current and future challenges. The study is a three-phase effort:

Phase I: Determine current JPME requirements and enabling Education Technology JPME applications (Phase I complete).

Phase II: COA development. Prepare leaders to meet the demands of current and future joint, interagency, and multinational environments, such as described in JV 2010.

Phase III: JPME 2010 development.

Review OPMEP and develop appropriate policy/documents to support the approved COA.

Determine manpower, educational and technology, and infrastructure requirements in support of approved COA for JPME 2010.

Develop required legislation to support the approved COA.

The results of Phase I and Phase II showed a requirement to develop a continuum of JPME that:

Expands the JPME audience (AC/RC).

Commitment to Distance and Advanced Distributed Learning (ADL).

Provides “one-stop” JPME shopping.

Resolves the TDY and return problem.

Deepens and broadens JPME content.

The recommended JPME COA includes:

Establish an Armed Forces Staff College Joint Operations School (JOS).

AFSC would stand up a 10-month, 100 student JOS:

Would count as an Intermediate Service School (ISS) attendance.

Phase I and Phase II JPME completion.

Accredited to award of a Masters degree.

AFSC would establish a two-month summer course for an additional 200 service school graduates unable complete JPME II

AFSC’s Joint Distributed Learning Center will develop a web-based curriculum based on the current three-month TDY and return resident course for export to:

Joint Learning Centers (JLCs) at the CINC’s Headquarters, Joint Staffs and other joint agencies.

ADL for distribution to the individual student (especially the RC).

Include a culminating exercise held at AFSC.

JPME Phase II curriculum offered at Intermediate and Senior Service schools to a portion of their student body in lieu of sending students to AFSC’s three-month course:

Proposed as a Spring Quarter elective to students slated for joint duty assignments.

Service School JPME II attendees would meet the “four pillars of jointness.”

Joint student body (estimate 650 students).

Joint faculty (Phase I and Phase II educated with JDA).

Joint curriculum (provided by AFSC).

CJCS oversight (certified and accredited by J7/MED).

FY00 JVLE Phase II/version 1.0:

- Research & Develop a JVLE Requirement Baseline.
- Conduct Research of available COTS & GOTS applications to meet JVLE requirements.
- Develop a JVLE architecture and version 1.0 design.
- Develop a JVLE version 1.0 IAW prioritized JVLE requirements baseline and field to specified locations.
- Identify existing DoD, CINC, and MECC educational content and add to the JVLE.
- Assist specified CINC and Regional Centers with JVLE Repository implementation.
- Develop a JVLE version 1.0 Training Module and capability.

FY 01 JVLE/ Phase III/ version 2.0:

- Re-validate JVLE Requirements Baseline with DoD customers.
- Begin procurement and fielding of JVLE Repository Backbone to specified DoD customers.
- Provide Operation & Maintenance (O&M) to selected/qualified JVLE customers.
- Provide JVLE Help-Desk.
- Begin developing selected DoD Joint Course Content for JVLE.
- Conduct JVLE User Training.
- Develop JVLE version 2.0 IAW selected additional features represented by JVLE Requirements Baseline.
- Field JVLE version 2.0 to appropriate DoD customers.

FY 02 JVLE/Phase IV/version 3.0:

- Re-validate JVLE Requirements Baseline with DoD customers.
- Continue procurement and fielding of JVLE Repository Backbone to specified DoD customers.
- Continue JVLE O&M and Help-Desk services.
- Continue development of selected DoD joint training course content for JVLE.
- Conduct JVLE user training.
- Develop JVLE version 3.0 IAW selected additional features represented by JVLE Requirements Baseline.
- Field JVLE version 3.0 to appropriate DoD customers.

FY 03 JVLE/ Phase V/version 4.0:

- Re-validate JVLE Requirements Baseline with DoD customers.
- Continue procurement and fielding of JVLE Repository Backbone to specified DoD customers.
- Continue JVLE O&M and Help-Desk services.

- Continue development of selected DoD joint training course content for JVLE.
- Conduct JVLE user training.
- Develop JVLE version 4.0 IAW selected additional features represented by JVLE requirements baseline.
- Field JVLE version 4.0 to appropriate DoD customers.

FY04 JVLE/Phase VI/version. 5.0:

- Re-validate JVLE Requirements Baseline with DoD customers.
- Continue procurement and fielding of JVLE Repository Backbone to specified DoD customers.
- Continue JVLE O&M and Help-Desk services.
- Continue development of selected DoD joint course content for JVLE.
- Conduct JVLE User Training.
- Develop JVLE version 5.0 IAW selected additional features represented by JVLE Requirements Baseline.
- Field JVLE version 5.0 to appropriate DoD customers.

FY 05 JVLE/Phase VII/version 6.0:

- Re-validate JVLE Requirements Baseline with DoD customers.
- Continue procurement and fielding of JVLE Repository Backbone to specified DoD customers.
- Continue JVLE O&M and Help-Desk services.
- Continue development of selected DoD joint course content for JVLE.
- Conduct JVLE user training.
- Develop JVLE version 6.0 IAW selected additional features represented by JVLE Requirements Baseline.
- Field JVLE version 6.0 to appropriate DoD customers.

## GLOSSARY

AC	Active Component
ACTD	Advanced Concept Technology Demonstration
ADL	Advanced Distributed Learning
ADLIP	Advanced Distributed Learning Implementation Plan
ADLI	Advanced Distributed Learning Initiative
ADLN	Advanced Distributed Learning Network
AEF	Air Expeditionary Force
AETC	Air Education and Training Command
AFADL	Air Force Advanced Distributed Learning
AFIADL	Air Force Institute for Advanced Distributed Learning
AFIT	Air Force Institute of Technology
AFRL	Air Force Research Laboratory
AFSC	Armed Forces Staff College
AFR	Air Force Reserve
AICC	Aviation Industry CBT Committee
ALX	America's Learning Exchange
ANG	Air National Guard
ANGDPD	Air National Guard Personnel Force Development Program
API	Application Program Interface
ARNG	Army National Guard
ASD/RA	Assistant Secretary of Defense for Reserve Affairs
ATSC	Army Training Support Center
AT	Authoring Tools

ATTA	Army Training Technical Architecture
CAPTOR	Crisis Action Planning Tutored On-Line Resource
CCB	Configuration Control Board
CDC	Career Development Course
C <sup>4</sup> I	Command, Control, Communications, Computers, and Intelligence
CD ROM	Compact Disc - Read Only Memory
CDSAR	Curriculum Development and Student Registration
CFM	Career Field Manager
CFT	Customer Focus Team
CGADLP	Coast Guard Advanced Distributed Learning Plan
CINCs	Commanders-in-Chief
CJCS	Chairman, Joint Chiefs of Staff
CJCSI	Chairman, Joint Chiefs of Staff, Instruction
CMI	Computer Managed Instruction
CNET	Chief of Naval Education and Training
CNGB	Chief, National Guard Bureau
CNO N7	Chief Naval Operations, Director of Naval Training
COA	Course of Action
CONUS	Continental United States
COTS	Commercial Off-The-Shelf
CPMS	Civilian Personnel Management Service
CFS	Course Structure Format
DAU	Defense Acquisition University



DCI	Director Central Intelligence
DCST	Deputy Chief of Staff for Training
DIA	Defense Intelligence Agency
DISA	Defense Information Security Agency
DJS	Director, Joint Staff
DLM	Dynamic Learning Management
DOCNET	Doctrine Networked Education and Training
DoD	Department of Defense
DoDEA	Department of Defense Educational Activity
DOMS CoMPIO	Director of Military Support, Consequence Management Program Integration Office
DS	Distributive Simulations
DTF	Digital Training Facilities
DTTP	Distributive Training Technology Project
DUSD(L)	Deputy Under Secretary of Defense for Logistics
DUSD(R )	Deputy Under Secretary for Defense for Readiness
DUSD(S&T)	Deputy Under Secretary of Defense for Science and Technology
EPSS	Electronic Performance Support Systems
ESG	Executive Steering Group
ETSC	Education and Training Steering Committee
FAQ	Frequently Asked Questions
FJTS	Future Joint Training System
FLTRC	Federal Learning Technology Resource Center
FLX	Federal Learning Exchange

FTTI	Federal Training Technology Initiative
FOC	Final Operational Capability
GAO	Government Accounting Office
HAZMAT	Hazardous Materials
HQDA	Headquarters, Department of the Army
HQ, AETC/DO	Headquarters, Air Education and Training Command, Director of Operations
HQ, AETC/ED	Headquarters, Air Education and Training Command, Director of Education
HQ, AETC/XP	Headquarters, Air Education and Training Command, Director of Plans
HQ, USAF/DPDT	Headquarters, United States Air Force Training Division
HQ, USAF/DP	Headquarters, United States Air Force, Director of Personnel
ICAI	Intelligent Computer Aided Instruction
IC	Intelligence Community
ICW	Interactive Courseware
IEEE	Institute of Electrical and Electronic Engineers
IMI	Interactive Multimedia Instruction
IMS	Instructional Management System
IOC	Initial Operational Capability
IPT	Integrated Process Team
ISS	Intermediate Service School
IT	Information Technology
ITRO	Interservice Training Review Organization

IVT	Interactive Video Tele-training
JADLN	Joint Advanced Distributed Learning Network
JC <sup>2</sup> RP	Joint Command and Control Research Program
JCE	JIVA Collaborative Environment
JDEIS	Joint Doctrine Electronic Information System
JDLC	Joint Distributed Learning Center
JDOL	Joint Doctrine Operations Laboratory
JDTC	Joint Deployment Training Center
JEL	Joint Electronic Library
JFCOM	Joint Forces Command
JIVA	Joint Intelligence Virtual Architecture
JDLS	Joint Digital Library System
JOS	Joint Operations School
JPME	Joint Professional Military Education
JPME 2010	Joint Professional Military Education 2010
J-6	Director for Command, Control, Communications, and Computers, JointStaff
J-7	Director for Operational Plans and Interoperability, Joint Staff
JSCAT	Joint Services Collaborative Action Team
JTA	Joint Technical Architecture
JTASC	Joint Training and Simulation Center
JTCWG	Joint Training Curriculum Working Group
JSEIG	Joint Systems Engineering Integration Group
JTF	Joint Task Force

JVLE	Joint Virtual Learning Environment
JV 2010	Joint Vision 2010
JWFC	Joint Warfighting Center
KBS	Knowledge Based System
LMS	Learning Management System
MAGTF	Marine Air Ground Task Force
MAJCOM	Major Command
Marine Net	Marine Corps Learning Network
MCCDC	Marine Corps Combat Development Command
MCDLP	Marine Corps Distance Learning Program
MECC	Military Education Coordination Conference
MOS	Military Occupational Specialty
MNS	Mission Need Statement
NATO	North Atlantic Treaty Organization
NCA	National Command Authority
NDI	Non-Developmental Item
NDU	National Defense University
NGB-ART	National Guard Bureau Army Training Division
NGB	National Guard Bureau
NIPRNET	Unclassified but Sensitive Protocol Router Network
NLN	Naval Learning Network
NSA	National Security Agency
OCONUS	Outside, Continental United States

OPMEP	Chairman of the Joint Chiefs of Staff (CJCS) Instruction CJCSI 1800.01 re Joint Staff Oversight of JPME
OPTEMPO	Operational Tempo
OSD	Office of the Secretary of Defense
OSTP	Office of Science and Technology Policy
OTL	Object Training Library
PCE	Professional Continuing Education
PEC	Professional Education Center
PEO/IS	Program Executive Office/ Information Systems
PERSTEMPO	Personnel Tempo
PfP	Partnership for Peace
PME	Professional Military Education
PMO	Product Management Office
POM	Program Objective Memorandum
QDR	Quadrennial Defense Review
RAID	Rapid Assessment and Initial Detection
RC	Reserve Component
RCB	Requirement Control Board
R&D	Research and Development
R-NET	Marine Reserve Network
ROI	Return on Investment
SCORM	Sharable Courseware Object reference Model
SDLN	Secure Distance Learning Network

SIPRNET	Secret Internet Protocol Router Network
SME	Subject Matter Expert
TADLP	Total Army Distance Learning Program
TATS	Total Army Training System
TDS	Training Development System
TDY	Temporary Duty
TFADLAT	Total Force Advanced Distributed Learning Action Team
TPIO	TRADOC Product Integration Office
TRADOC	U.S. Army Training and Doctrine Command
TRANSCOM	U.S. Transportation Command
TWG	Technical Working Group
UCP-99	Unified Command Plan of 1999
USACOM	United States Atlantic Command
USAF	United States Air Force
USD(A&T)	Under Secretary for Defense for Acquisition and Technology
USD(P&R)	Under Secretary of Defense for Personnel and Readiness
USCINCFCOM	United States, Commander in Chief, Joint Forces Command
USMC	United States Marine Corps
VE	Virtual Environment
VRML	Virtual Reality Modeling Language
VTT	Video Teletraining
WAN	Wide-Area Network
WMD	Weapons of Mass Destruction

WWW

World-Wide Web

XML

Extensible Markup Language

## ***Perspectives from Key Department of Defense Leaders (Continued)***

“What impact will rapid change of today have on professional military education? The answer is that it will be dramatic. Moreover, the revolution in military affairs suggests a corresponding revolution in military education which transforms the who, what, when, where, and how of military education. Military education, especially joint professional military education, must be seamless, continuous, and career-long. It must be needs-based, available on demand, and offered just in time. It must be more information technology-based (even network centric) as well as more experiential and virtual. And it must be fused with operations, integrate resident and nonresident instruction, and appeal to both military and civilian components as well as international institutions. These are the features of a revolution in military education, and it is under way.”

**Lieutenant General Richard Chilcoat,**  
**President of the National Defense University,**  
The Revolution in Military Education,  
1999 Joint Force Quarterly Magazine

“Cognitive Readiness is both a critical component and a criterion for the Department of Defense’s Science and Technology strategy for achieving the national defense capabilities articulated in Joint Vision 2010. It forces emphasis on achieving national advantage through optimizing the capability and employment of our people—our nation’s greatest asset—for peace as well as war. ADL, in turn, provides a supportive strategy that will contribute to the achievement of cognitive readiness. Accelerated and sustained S&T investment in ADL should yield near- and mid-term dividends that will dramatically enhance our forces’ cognitive readiness.”

**Dr. Delores Etter,**  
**Deputy Under Secretary of Defense for Science and Technology,**  
Cognitive Readiness and Advanced Distributed Learning,  
CrossTalk, The Journal of Defense Software Engineering,  
March 2000

***For additional information  
Visit  
<http://www.adlnet.org>***

