

GeoTime for C²

Thomas Kapler & William Wright

SASO Command & Control Challenges

2

- Track people, equipment, organizations and their activities over time.
- Tracking projects, schedules. Example: reconstruction,
- In situations of asymmetric warfare, stability and support operations and peace support operations, tracking relatively small and seemingly unconnected events over time becomes a means for gaining insight into enemy or insurgent behavior.
- Local cultures, characters, organizations and their behaviors play an important part in planning and mission execution.
- Small attacks come from unknown assailants over long periods of time, making it difficult to see patterns.
- Tracking relationships between events, suspects, known personalities and organizations.
- Information obtained is piecemeal.
- The key dimensions of this information are who, what, where, when, how, why and with-whom

C² Event Tracking

3

- Current C2 Systems Track events separately Tables, Charts and Maps
- Difficult for users to get a complete picture of events across all dimensions
 - Space
 - Time
 - Sequence
 - Relationships
 - Event Type
 - Movement
- Each dimension shown in separate views
- Reliance on human memory to make connections and correlations across these dimensions is a significant cognitive task
 - Result: analysis suffers
 - Proper analysis takes a great deal of time
 - Patterns are missed

Event Tracking over Time: Examples

4

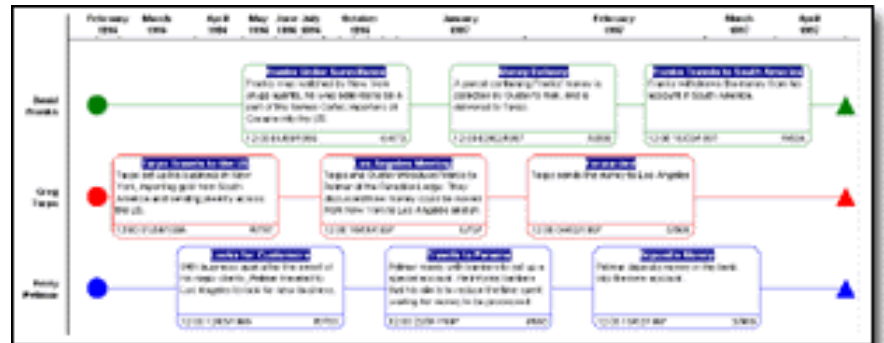
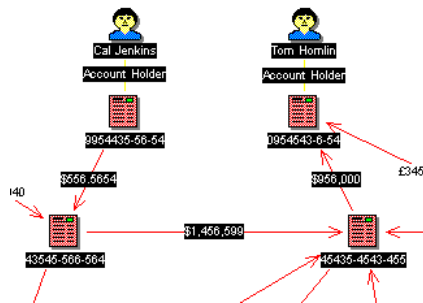
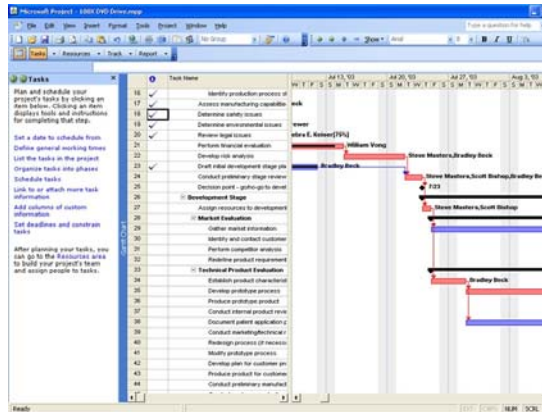
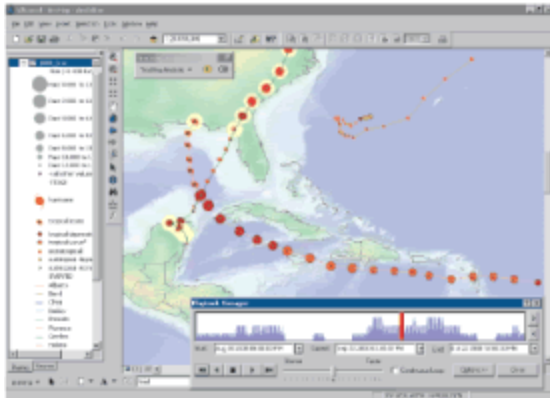

GeoTime concept

5

- Visually depict events over time and space *concurrently* – x,y,t space (or $x,y,z-t$ with Elevation data)
- Develop data model for representing Events and Entities involved in events
- Show linkages and relationships
- Show descriptive event icons
- Develop the visualization interface as a viable analyst workspace for exploration, deep analysis and presentation.

GeoTime Visualization Principle

6

- Diagram showing how individual frames of movement are translated into a continuous spatiotemporal representation

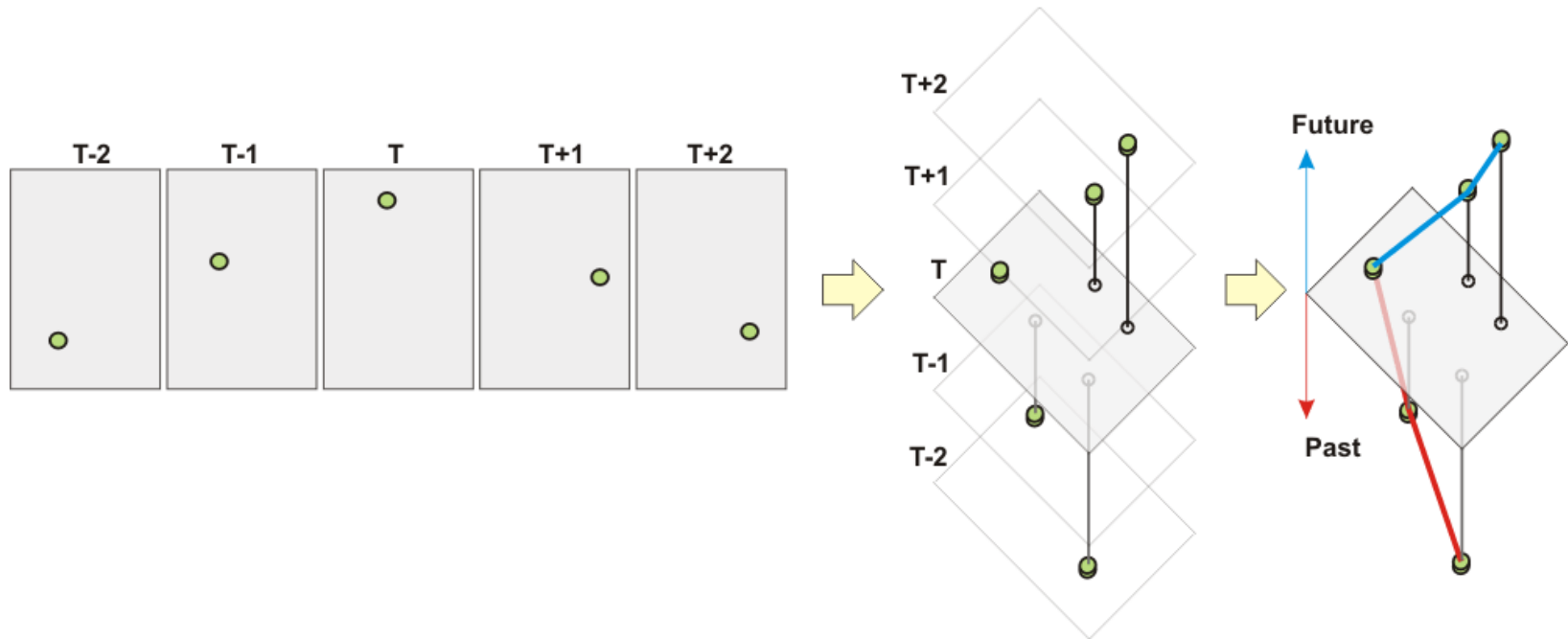

Time Tracks

7

- Spatial Time tracks make possible the perception of *where* and *when*.
- Primary organizing device for display of events in time and space within a single view.
- Time-tracks represent a stream of time through a particular Location and are represented as a literal line in space.

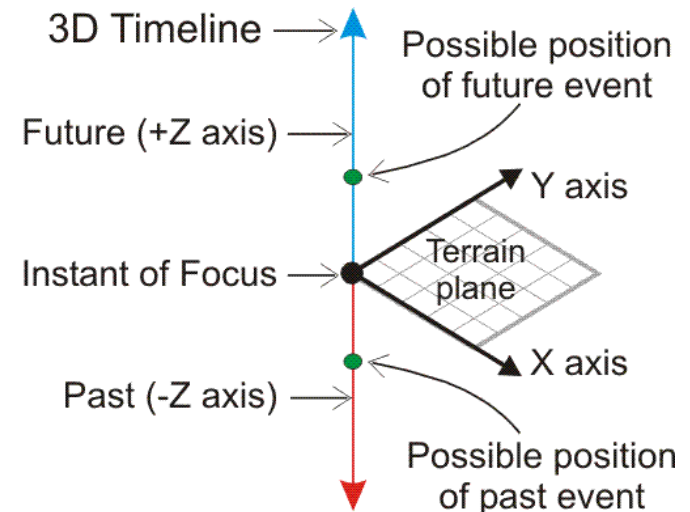

Time Track Layouts

8

- Several Time Track layout schemes have been developed
- Each seems to have particular properties that emphasize different aspects of the data
- User preference has not been evaluated

3D Layout

9

- Emphasizes spatial quality of data
- Temporal comparison is less accurate

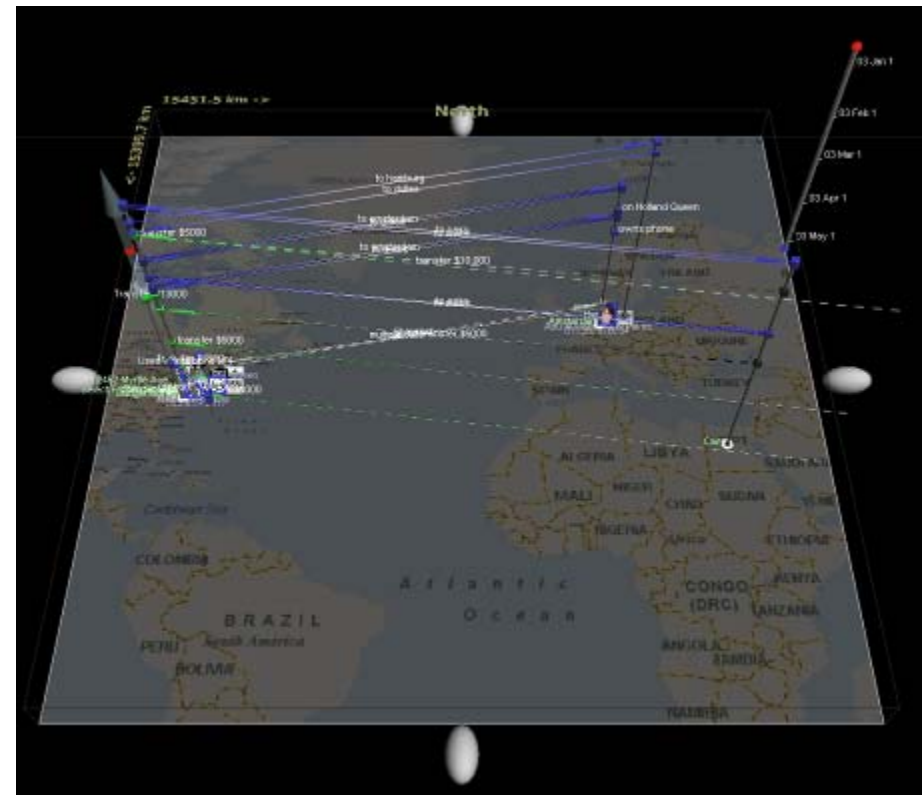
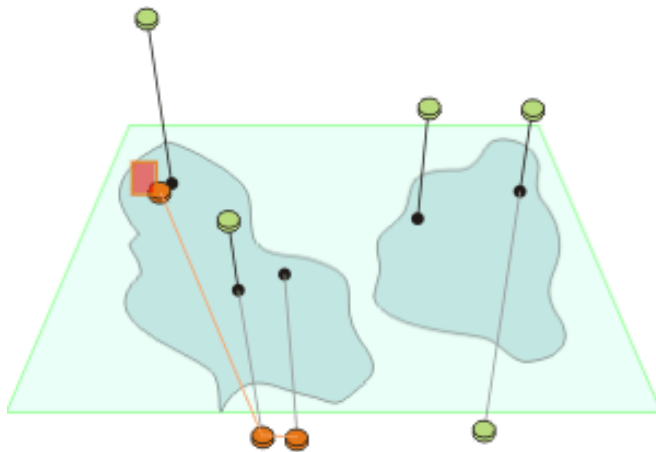

Viewer Facing

10

- Time tracks always oriented to viewer
- Temporal comparison is consistent since perspective distortion is reduced

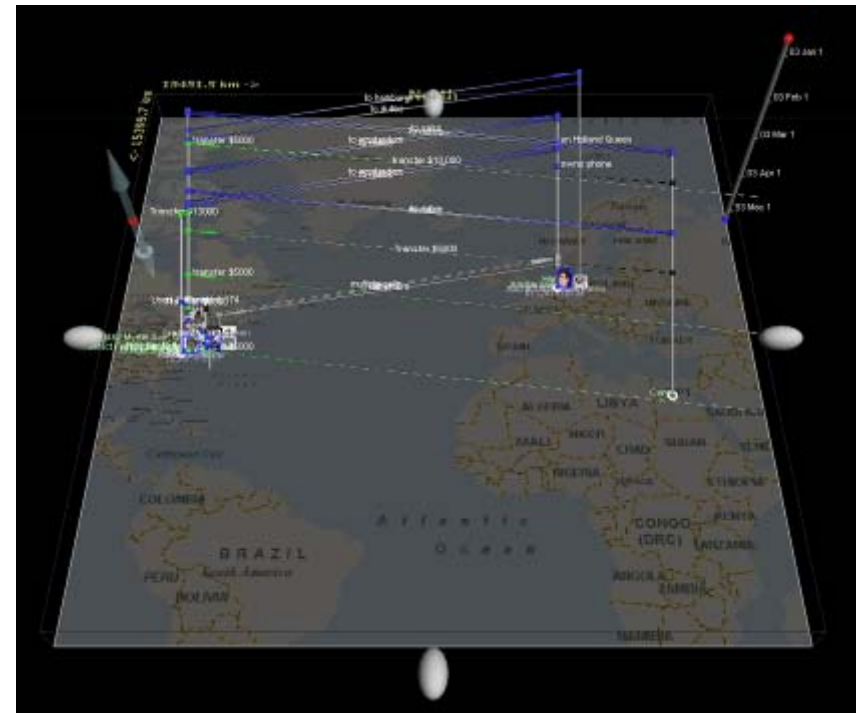
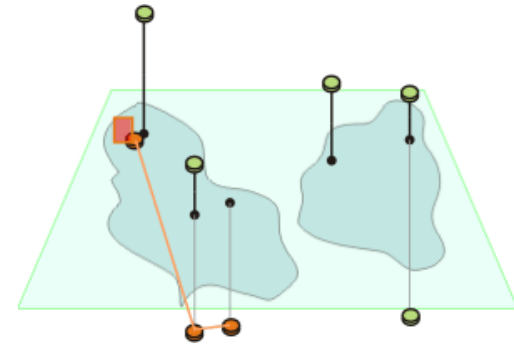
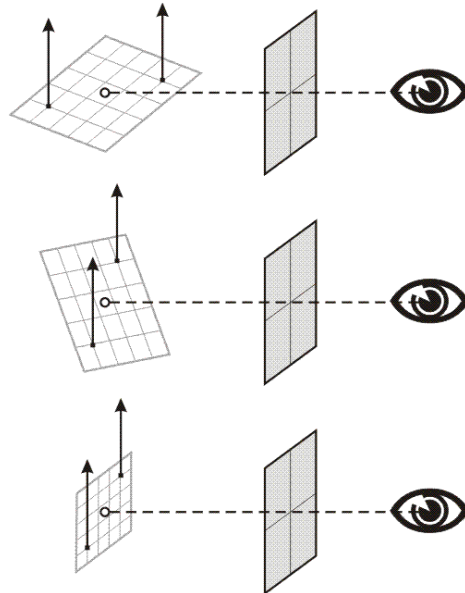

Calendar Modes

11

- Timeline chart overlaid and connected to the geographic dimension
- Emphasizes temporal comparison

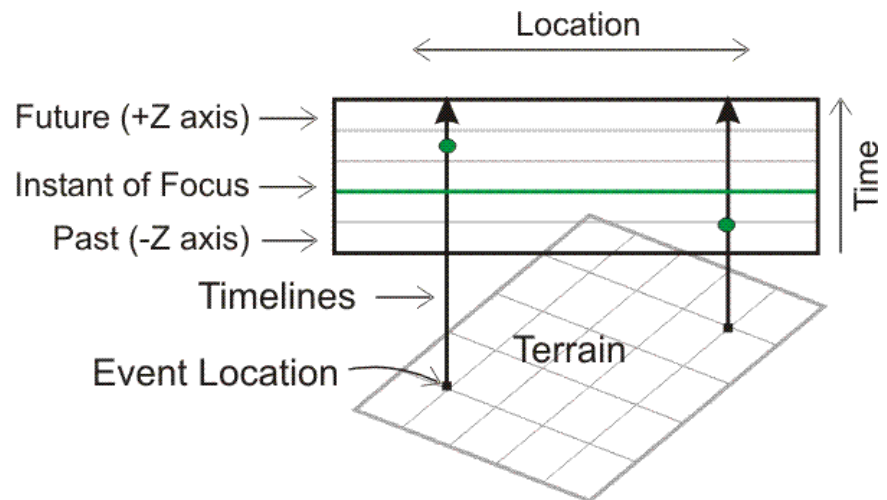
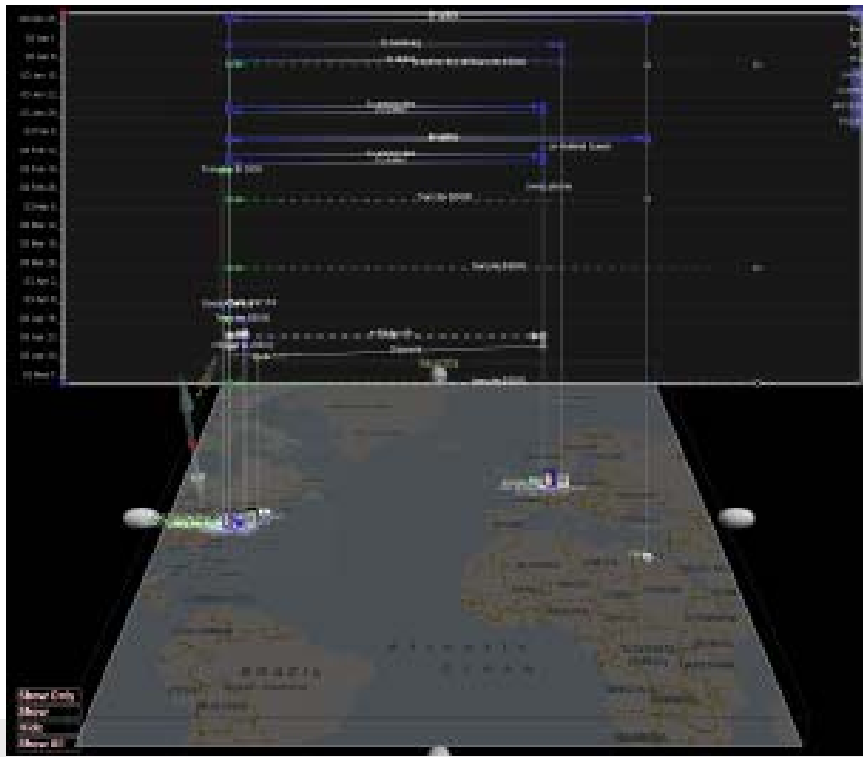
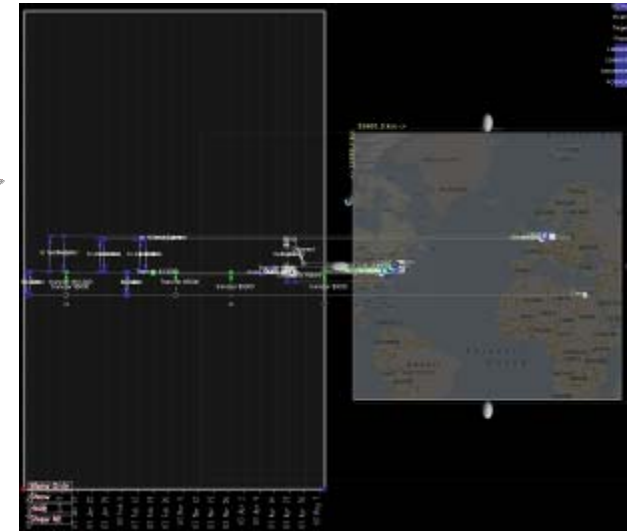
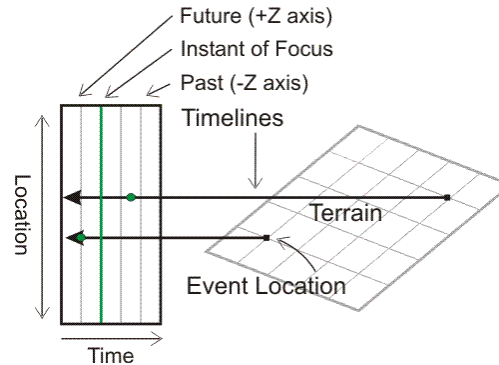

3D Geospatial Display

12

- Where it is relevant, 3D terrain can be displayed

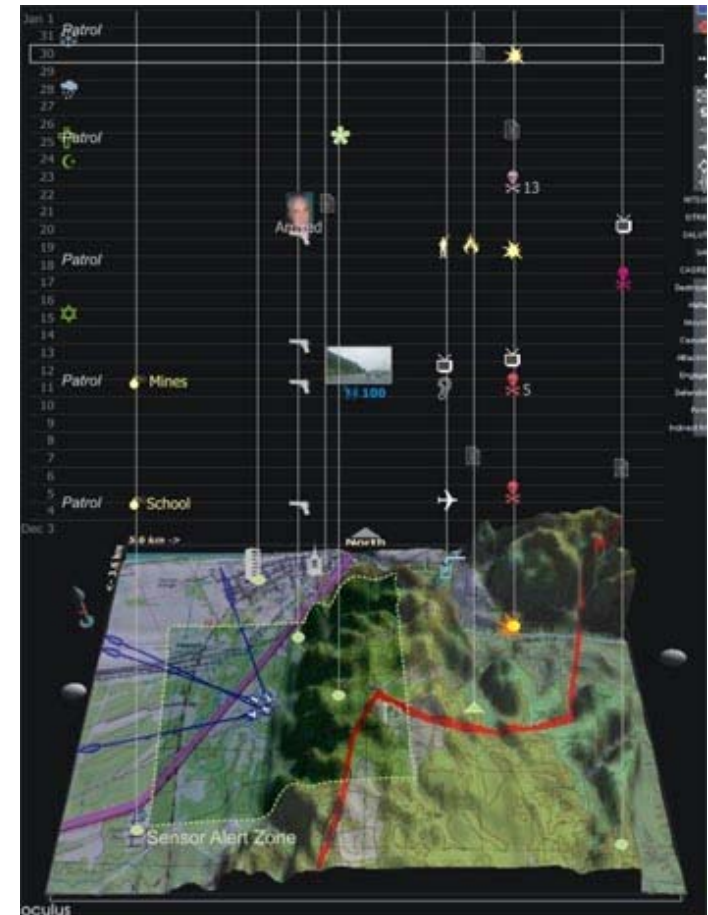
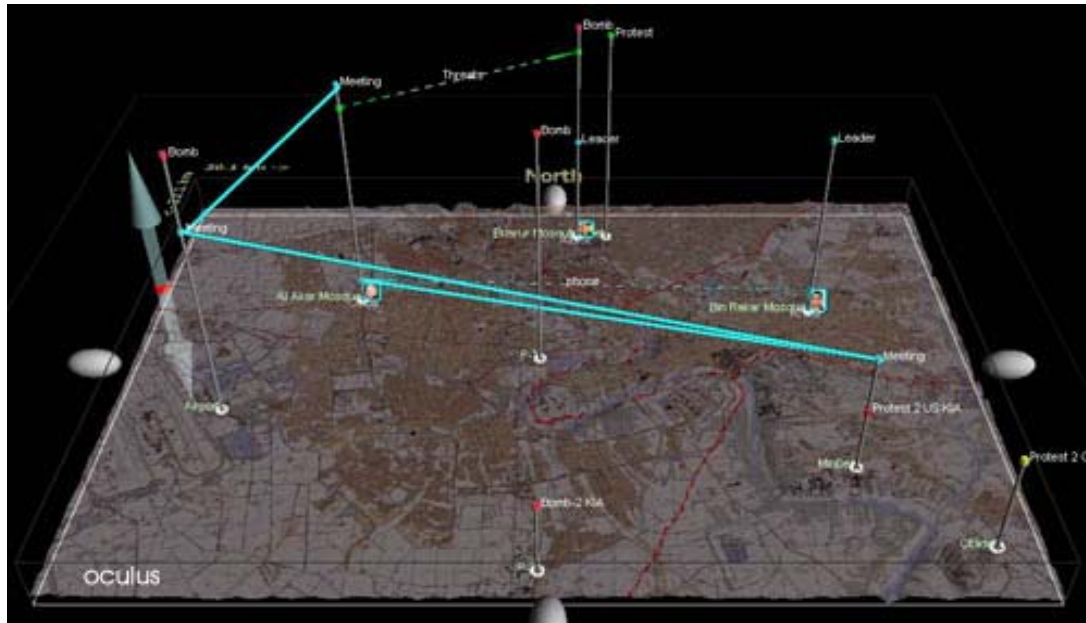

Timeline Controls

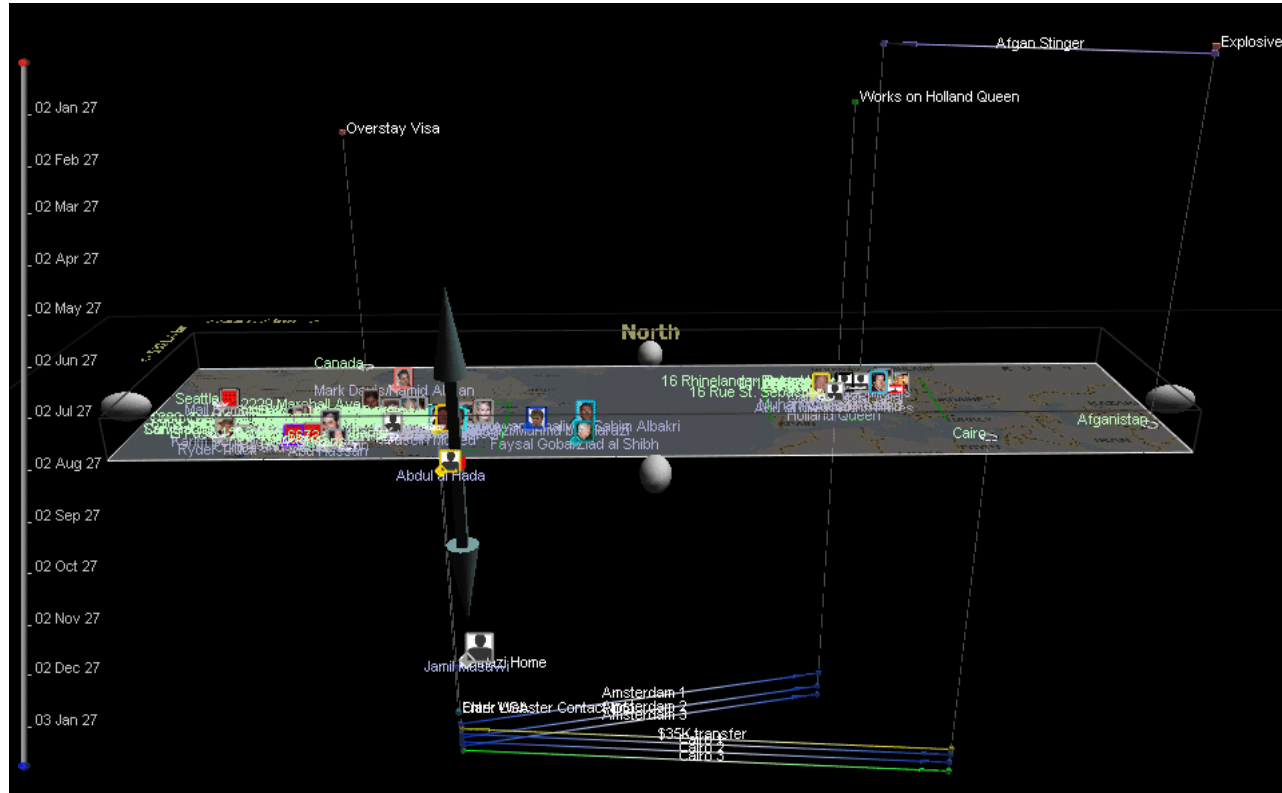

Past Time
(Above ground)

Instant of Focus
(Ground level)

Future time
(Below ground)

NOTE: The direction of future and past can be reversed if preferred.

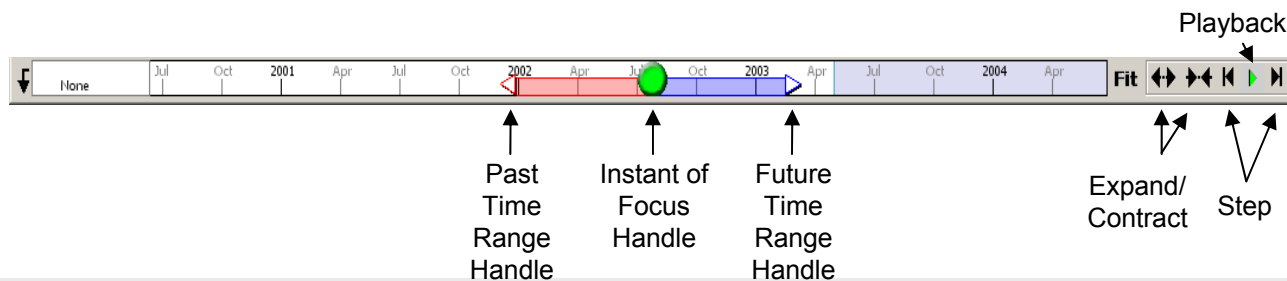

Information Architecture

14

An information model based loosely on Davidsonian semantics [Davidson, 1980] is used to support the representation of information in GeoTime. The following objects types are employed in GeoTime.

Entities (*people or things*) – *who?*

- represent any thing related to or involved in an event including people, objects, organizations, equipment, businesses, observers, affiliations etc.

Locations (*geospatial or conceptual*) – *where?*

- represent a place within a spatial context, such as a geospatial map, a node in a diagram such as a flowchart, or even a conceptual place such as "OZ".

Events (*occurrences or discovered facts*) – *what, how?*

- represent any action that can be described. The following are examples of events
 - Bill was at Toms house at 3 pm
 - Tom phoned Bill on Thursday
 - A tree fell in the forest at 4:13 am, June 3, 1993
 - Tom will move to Spain in the summer of 2004
- Events store the times at which the action took place.

Associations

- An association is an information object that describes a pairing between two objects.

Taxonomy of Observation Groups

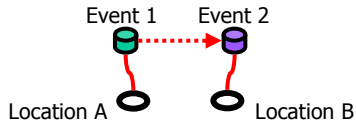

Soft Vector Group
 (Phone Call, email, money transfer)
 3 Associations:
 •Event1 occurred at Location A
 •Event 2 occurred at Location B
 •Event 1 directed at Event 2

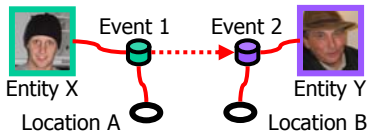
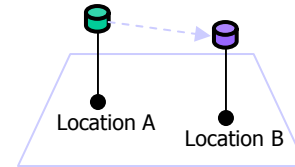

Vector Group with Actors
 (Phone Call, email, money transfer)
 5 Associations: Same as above plus...
 •Entity X present at Event 1
 •Entity Y present at Event 2

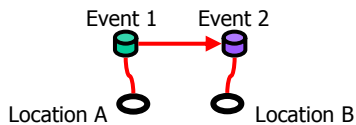
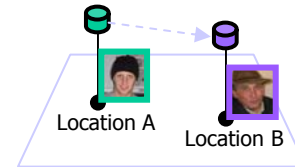

Hard Vector Group
 (Documented transport such as air or boat travel)
 3 Associations:
 •Event1 occurred at Location A
 •Event 2 occurred at Location B
 •Something moves to Event 2

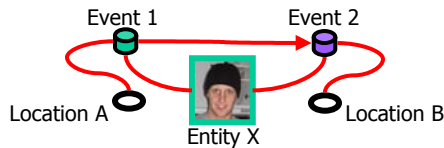
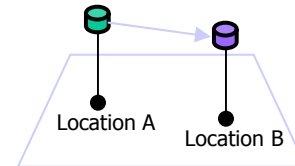

Hard Vector Group with Actors
 (Transport of a person or thing)
 5 Associations: Same as above plus...
 •Entity X present at Event 1 (departure)
 •Entity X present at Event 2 (arrival)

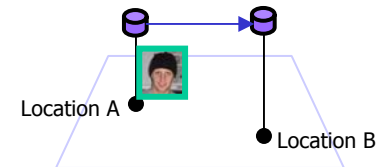

Taxonomy of Groups Cont...

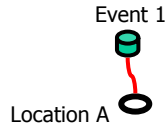

Observation Group
(An Incident, news item or observation)
 1 Association
 •Event 1 occurred at Location A

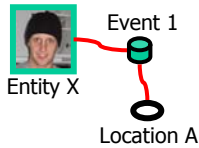
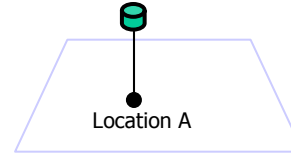

Observation with Actor
(Involvement in an incident, observer)
 2 Associations:
 •Event 1 occurred at Location A
 •Entity X present at Event 1

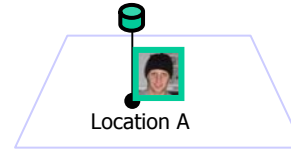

Actor Relationship
(Familial or employer-employee relationships, organization membership)
 2 Associations:
 •Entity X member of Event 1
 •Entity Y member of Event 1

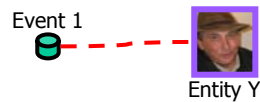
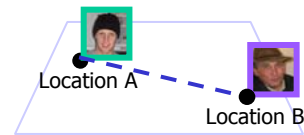

Observation Relationship
(Indirect involvement)
 1 Association:
 •Entity X member of Event 1

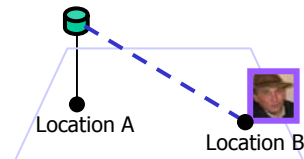

Entity Animation

Method for animating entity movement between events during time slider interaction

-  **Event 1**
Entity X observed at Location A at time t
-  **Event 2**
Entity X observed at Location B at time $t+2$

1. At time t , Entity X is rendered at Event1 (Location A)

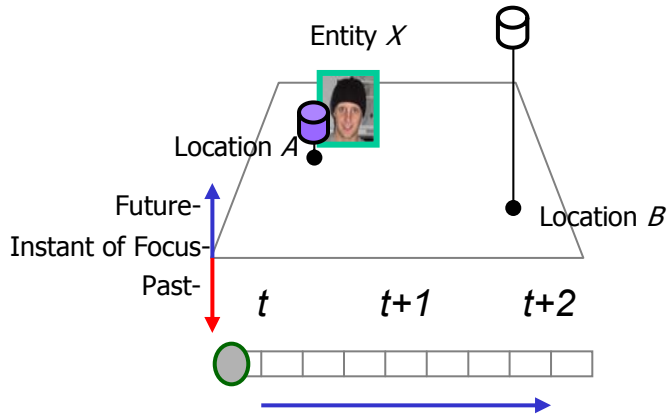

2. At time $t+1$, Entity X is shown moving between known locations (Event1 and Event2)

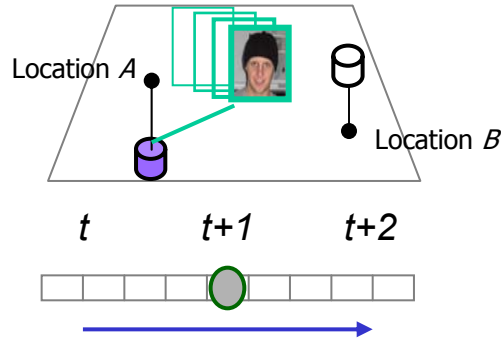

3. At time $t+2$, Entity X is rendered at Event2 (Location B)

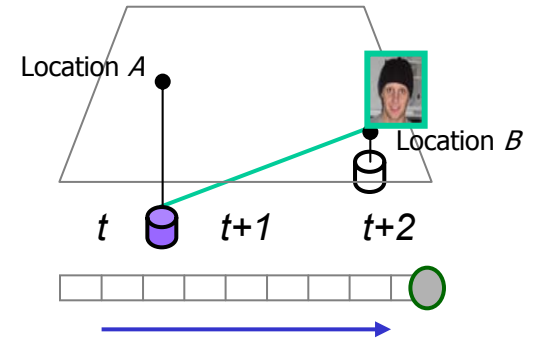

The Time Slider is dragged by the user to replay the sequence of events from time t to $t+2$

Entity Movement & Communication

18

- Method for showing communication and movement events between Entities over time.
- This diagram shows a static view of Entity X making 3 phone calls to Entity Y from 3 different locations at 3 different times.
- A trail is drawn to show previous time and space positions for Entity X

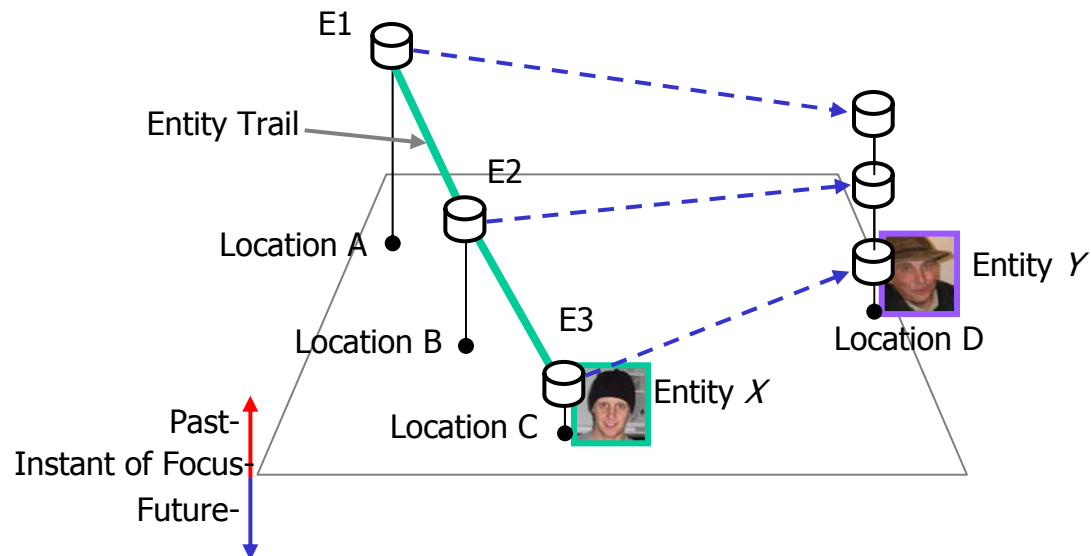
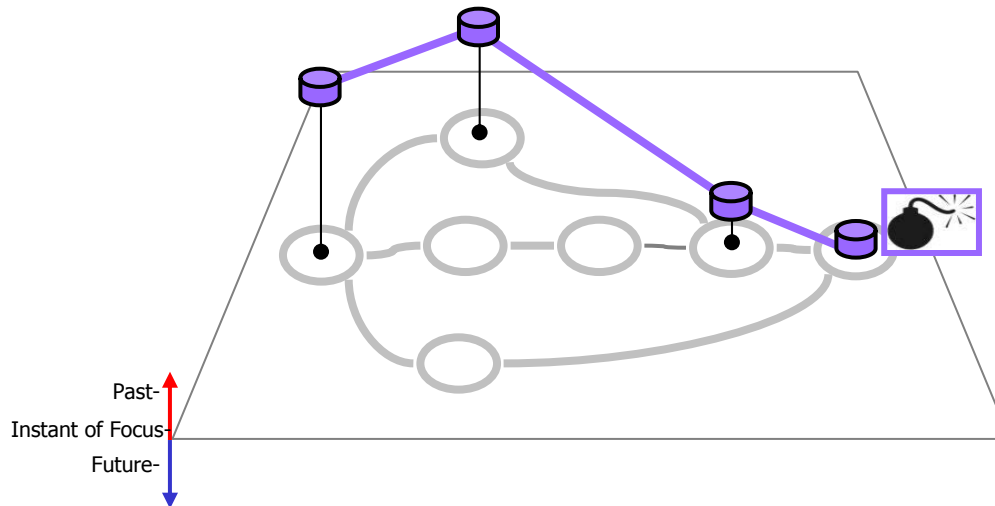

Diagram Space Concept

19

- Method for showing Events occurring within a process diagram-space over time
- This diagram shows how a flowchart or other graphic can be used as a spatial context for GeoTime analysis. In this case the object (entity) has been tracked through a production process to the final stage.



Path and Link Discovery

20

- Tools for finding connections
 - Reveals stories
 - Also helps to de-clutter display

- 2 Types

- Radial Connections
 - Select an object and incrementally spread outwards to connected events, places and targets
- Connections Between Points
 - Select any 2 objects and see the paths connecting them
 - Automatically finds the shortest path

Increments out from a node

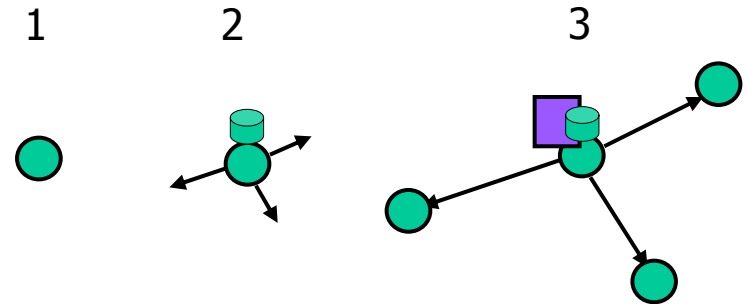

Find paths between selected nodes

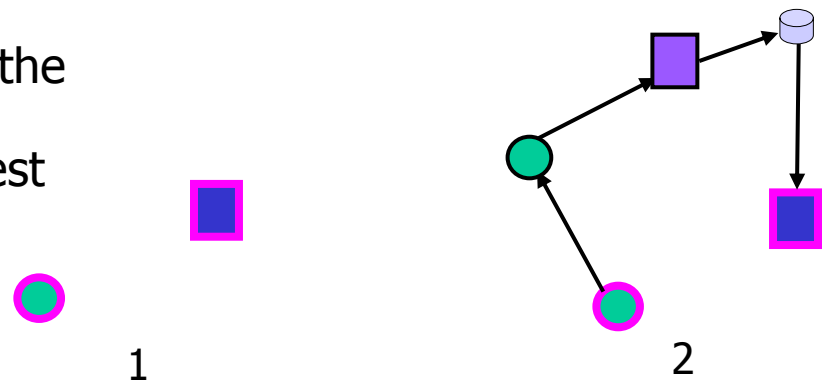

Link Discovery Operations

- Link analysis functions use the structure of associations to trace links between objects

Sequence of Linked Objects showing associations in red

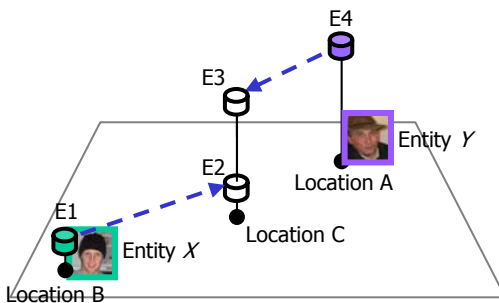
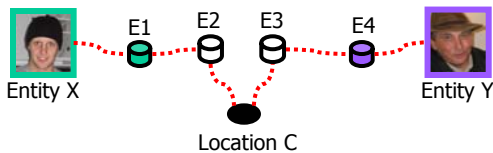





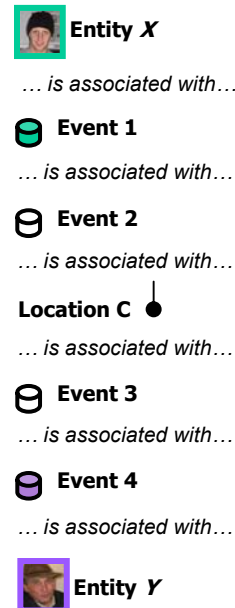























Example of linked entities as they would appear in the display

Sequence of Linked Objects



Descriptive Event Icons

- **Business Act**
 - Personnel Act (Fire, Hire, Promote, etc)
 - Businesses Act (Bankrupt, Merge)
- **Communication Act**
 - Broadcast 
 - Mailing  
 - Meeting
 - Net Communication  
 - Email Act
 - News Post
 - Telephone Call 
 - Telegraph
- **Employment**
- **Judicial Act (Conviction, Execution, Imprisonment, etc)**  
- **Movement**
 - Transfer*
 - Travel 
- **Personal Act (Birth, Death, Wedding, etc)** 
- **Planning**
- **Police Act (Arrest, Detainment, Seizure, etc)** 
- **Political Act (Election, Impeachment, Recall, etc)** 
- **Production** 
 - Construction
 - Crop Production
 - Document Production
 - Manufacture 
- **Terrorist Act**
 - Assassination  
 - Attack 
 - Bombing 
 - Hijacking
 - Hostage Taking 
 - Kidnapping
- **Surveillance**
- **Training**
 - Religious Training 
 - Secular Training
 - Weapons Training 
- **Trans**
 - Financial Transfer 
 - Transaction
 - Loan 
 - Purchase 
 - Theft 
 - Transfer* 
 - Sending
- **Transportation**  

Plus Standard 2525b Symbols

Demonstration

23

- Afghanistan Events
- Kapler Family Events

User Task Space

24

-Tracking Insurgents
-Tracking Equipment

- All Source IC Analyst
- Multiple Spatial Contexts
- Flat Earth
- IC Application
- User enters data - logbook
- Track people, money, orgs
- View Query Results

- Structured
- Long term
- All Source
- Vetted Data
- User-guided Input
- Tracking over time
- Structured Archive
- High Connectedness

- Unstructured
- Short Term
- Single Source
- Raw Data
- Data from feed or query
- Scanning
- Data ages quickly
- Low Connectedness

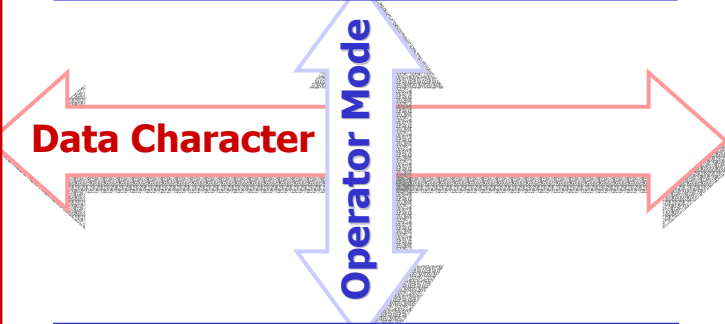

SASO?

- User in the field, Intel officer
- Geographic Emphasis
- 3D Terrain
- Military operation
- Track equipment and activity
- External data sources
- View Query Results

- Operational
- Adhoc Queries

Questions GeoTime Addresses

25

- What significant events happened in this area in the last X days?
- Where have all the instances of this type of event occurred?
- Is there a pattern to these events in time?
- Who was involved?
- What is the history of this person?
- Who have they communicated with?
- Where are the hot spots?
- Has this type of event occurred here or elsewhere in the last Y years

Acknowledgement

- This study was supported and monitored by the Advanced Research and Development Activity (ARDA) and the National Geospatial-Intelligence Agency (NGA) under Contract Number 5FUSA-03X105/001/SV
- The views, opinions, and findings contained in this report are those of the author(s) and should not be construed as an official Department of Defense position, policy, or decision, unless so designated by other official documentation.
- The authors wish to thank the ARDA GI2Vis program (Advanced Research and Development Activity, Geospatial Intelligence Information Visualization Program), and all ARDA staff for their support and encouragement.