

NOT MEASUREMENT
SENSITIVE

DOE-HDBK-1129-99
March 1999

DOE HANDBOOK

TRITIUM HANDLING AND SAFE STORAGE



U.S. Department of Energy
Washington, D.C. 20585

AREA SAFT

This document has been reproduced from the best available copy.

Available to DOE and DOE contractors from ES&H Technical Information Services, U.S. Department of Energy, (800) 473-4375, fax: (301) 903-9823.

Available to the public from the U.S. Department of Commerce, Technology Administration, National Technical Information Service, Springfield, VA 22161; (703) 605-6000.

TABLE OF CONTENTS

<u>SECTION</u>	<u>PAGE</u>
FOREWORD.....	vii
ACRONYMS	ix
1.0 INTRODUCTION.....	1
1.1 Purpose	1
1.2 Scope	1
1.3 Applicability.....	1
1.4 Referenced Material for Further Information.....	2
2.0 TRITIUM.....	3
2.1 Radioactive Properties.....	3
2.2 Physical Properties	4
2.3 Chemical Properties.....	5
2.4 Biological Properties	5
2.5 Preferred Forms.....	7
3.0 BASIC TRITIUM REGULATORY INFORMATION	17
3.1 Tritium Accountability.....	17
3.2 Tritium Safeguards and Security	21
3.3 Tritium Facility Safety Analysis and Regulatory Quantity Limits	22
3.4 Radiological Materials Quantity Limits.....	27
3.5 Tritium Unpackaging, Handling, and Packaging Areas, Quantity Limits	28
3.6 Tritium Waste Collection and Waste Packaging Area, Quantity Limits	28
3.7 Tritium Focus Group (TFG).....	28
4.0 FACILITY DESIGN.....	28
4.1 Tritium System Philosophy.....	28
4.2 Building Ventilation System.....	38
4.3 Chilled Water System	40
4.4 Seismic and Wind Design and Evaluation of Structures and Facilities	40
4.5 Other Design Considerations	42
4.6 Lessons Learned	43
5.0 DESIGN OF EQUIPMENT.....	46
5.1 Material Compatibility.....	47
5.2 First Wall Design.....	52
5.3 Secondary Wall Design.....	53
5.4 Cleanup System Design	53
5.5 Storage System Design	53
5.6 Surveillance and Maintenance	55
5.7 Seismic Considerations	55
5.8 Fire Scenarios.....	60
5.9 Instrumentation	60
6.0 TRITIUM PURCHASING AND RECEIVING	65
6.1 Shipping Packages	65
6.2 Product Containers	66
6.3 Valve Container Operations	68

DOE-HDBK-1129-99

6.4 Receiving Tritium 72
6.5 Storage of Packaged Nuclear Materials 72

7.0 PACKAGING AND TRANSPORTATION 73
7.1 General Administrative Packaging and Transport Requirements 73
7.2 Selection of Proper Packaging 73
7.3 Package Loading and Preparation for Shipment 79
7.4 Documentation and Records 80
7.5 Quality Assurance/Control Requirements 84

8.0 TRITIUM WASTE MANAGEMENT 85
8.1 Approved Limits for the Release of Contaminated Materials and Property Containing
Residual Radioactive 86
8.2 Waste Characterization 93
8.3 Waste Packaging 98
8.4 Waste Shipping 99

FIGURES:

FIGURE 2-1. Rate of tritium decay of one mole of tritium 4
FIGURE 2-2. Pressure versus time in a container of tritium 4
FIGURE 2-3. Comparison of aqueous tritium levels found in the nuclear industry 9
FIGURE 2-4. Dissociation pressure for uranium, hydride, deuteride, and tritide 11
FIGURE 2-5. Plot of a good fit curve for the dissociation pressure of uranium hydride,
deuteride, and tritide 11
FIGURE 2-6. Dissociation pressure of palladium hydride and deuteride 13
FIGURE 4-1. Tritium facility single-pass ventilation system 30
FIGURE 4-2. Secondary containment 32
FIGURE 4-3. Secondary confinement 32
FIGURE 4-4. Building confinement system 33
FIGURE 4-5. Typical gas-to-water tritium removal system flow schematic 34
FIGURE 4-6. Confinement volume cleanup rate as a function of system time constant, F/V,
assuming an exponential dilution rate 36
FIGURE 5-1. Development of the seismic equipment list 58
FIGURE 5-2. Comparison of seismic capacity spectra to seismic demand spectra 59
FIGURE 6-1. Use of double valve container 69
FIGURE 6-2. Purge ports and isolation valves 70
FIGURE 8-1. Ultimate disposition of tritiated material 97

TABLES:

TABLE 2-1. Derived air concentrations for tritium and tritiated water 6
TABLE 2-2. ICRP-71 dose conversion factors for inhalation of tritiated particulates 7
TABLE 2-3. Dissociation pressure equation parameters for uranium hydride, deuteride,
and tritide 10
TABLE 2-4. Dissociation pressure equation parameters for palladium hydride and deuteride .. 13
TABLE 3-1. EPA maximum contaminant level for tritium 20
TABLE 3-2. Worst-case doses in rem resulting from release of 1 Ci of tritium 24
TABLE 5-1. Representative equipment found in tritium facilities 57
TABLE 5-2. SAM technical specifications 65
TABLE 7-1. Allowable quantities of tritium per 49 CFR 173 76

APPENDICES:

APPENDIX A:	USEFUL NUMERICAL VALUES
APPENDIX B:	DEFINITIONS
APPENDIX C:	ASSAY METHODS
APPENDIX D:	CONTAMINATION AND SURFACE ACTIVITY THRESHOLDS
APPENDIX E:	RESOURCES USED IN WRITING THIS HANDBOOK
APPENDIX F:	TRITIUM FOCUS GROUP CHARTER

This page is intentionally blank.

FOREWORD

Tritium handling practices have evolved over several decades at Department of Energy tritium facilities. The objective has been to accomplish required tritium work while minimizing and controlling the exposure of workers, the public, and the environment from tritium. This document provides guidance for the handling, storing and shipping of tritium. Literature references furnish information current through mid-1998.

This Department of Energy Handbook is approved for use by all DOE components and their contractors. There are no requirements generated by this document, only requirements referenced from other sources.

The principal authors, Bill Weaver of DOE-EH and William R. Wall of LLNL and SNLL, wish to acknowledge the contributions of Jim Bachmaier and Bill Fortune of DOE-EH; Elliot Clark and Bob Rabun of WSRC; Ray Hahn of Envirocare; Ron Hafner, Gary Mansfield, Mark Mintz, Robert C. Murray, and Stanley C. Sommer of LLNL; Tobin Oruch and Diana West of LANL; Mike Rogers and Paul Lamberger of Mound; Nazir Kherani of Ontario Hydro; Keith Rule of PPPL; Jeff Paynter of E2 Consulting Engineers; Phil Grant and Barbara Kneece of Wastren; and Jimmy Myers and Elaine Merchant of Parallax, Inc.

This page is intentionally blank.

ACRONYMS

AEA	Atomic Energy Act of 1954
ALARA	As Low As Reasonably Achievable
ALI	Annual Level of Intake
APT	Accelerator Production of Tritium
ASCE	American Society of Civil Engineers
ASME	American Society of Mechanical Engineers
ANSI	American National Standards Institute
CEDE	Committed Effective Dose Equivalent
CERCLA	Comprehensive Environmental Response, Compensation, and Liability Act
CLWR	Commercial Light Water Reactor
CoC	Certificate of Compliance
CWA	Clean Water Act
D&D	Decontamination and Decommissioning
DAC	Derived Air Concentration
DBA	Design Basis Accident
DBE	Design Basis Earthquake
DCF	Dose Conversion Factor
DCG	Derived Concentration Guide
DNFSB	Defense Nuclear Facilities Safety Board
DOE	U.S. Department of Energy
DOT	U.S. Department of Transportation
EDL	Economic Discard Limit
EH	Office of Environment, Safety and Health
EPCRA	Emergency Planning and Community Right-to-Know Act
EPDM	Ethylene Propylene Diene Monomer
EPA	Environmental Protection Agency
EIS	Environmental Impact Statement
FCA	Fire Control Area
FDTAS	Field Deployable Tritium Analysis System
FY	Fiscal Year
HDPE	High Density Polyethylene
HIVES	Highly Invulnerable Encased Safe
HMR	Hazardous Material Regulations
HSV	Hydride Storage Vessel
HSWA	Hazardous and Solid Waste Amendments
HTP	Hydride Transport Vessel
HTV	Hydride Transport Vessel
HVAC	Heating, Ventilation, and Air Conditioning
IAEA	International Atomic Energy Agency
ICRP	International Commission on Radiological Protection
ISM	Integrated Safety Management
keV	Kilo-Electron-Volts
LANL	Los Alamos National Laboratory
LLNL	Lawrence Livermore National Laboratory
LDR	Land Disposal Restriction
LSA	Low Specific Activity
LDPE	Low-Density Polyethylene

DOE-HDBK-1129-99

LLD	Lower Limit of Detection
LLW	Low-Level Waste
mCi	Millicurie
MCL	Maximum Contaminant Level
MEI	Maximally Exposed Individual
mm	Millimeters
mrem	Millirem
NFPA	National Fire Protection Association
NPDWR	National Primary Drinking Water Regulation
NPH	Natural Phenomena Hazard
NRC	U.S. Nuclear Regulatory Commission
PC	Performance Category
PCB	Polychlorinated Biphenyl
PMR	Palladium Membrane Reactor
PPPL	Princeton Plasma Physics Laboratory
psia	pounds per square inch absolute
psig	pounds per square inch gauge
PTFE	Polytetrafluoroethylene
PVC	Polyvinyl Chloride
PV	Product Vessel
RCRA	Resource Conservation and Recovery Act
RMA	Radioactive Materials Area
RTF	Replacement Tritium Facility
SAES	Società Apparecchi Elettrici e Scientifici
SAM	Surface Activity Monitor
SAR	Safety Analysis Report
SCO	Surface Contaminated Object
SEL	Seismic Equipment List
SEP	Seismic Evaluation Procedure
SMT	Stable Metal Tritide
SNL	Sandia National Laboratory
SNLL	Sandia National Laboratory, Livermore
SNM	Special Nuclear Material
SRS	Savannah River Site
SSCs	Structures, Systems, and Components
TRL	Tritium Research Laboratory, Sandia National Laboratory
TSD	Treatment, Storage, and Disposal
TSR	Technical Safety Requirement
UBC	Uniform Building Code
UHMWPE	Ultra-High-Molecular-Weight Polyethylene
WETF	Weapons Engineering Tritium Facility, Los Alamos National Laboratory
WSRC	Westinghouse Savannah River Company

1.0 INTRODUCTION

There are several tritium-handling publications, including International Atomic Energy Agency (IAEA) Technical Report Series, Number 324, "Safe Handling of Tritium," published in 1991; and U.S. Department of Energy (DOE) publications, most notably DOE Handbook, DOE-HDBK-1079-94, "Primer on Tritium Safe Handling Practices," published in 1994. The DOE Handbook was developed as an educational supplement and reference for operations and maintenance personnel. Most of the tritium publications are written from a radiological protection perspective. This handbook provides more extensive guidance and advice on the full range of tritium operations.

1.1 Purpose

This handbook can be used by personnel involved in the full range of tritium handling from receipt to ultimate disposal. Compliance issues are addressed at each stage of handling. This handbook can also be used as a reference for those individuals involved in real time determination of bounding doses resulting from inadvertent tritium releases.

1.2 Scope

This handbook provides useful information for establishing processes and procedures for the receipt, storage, assay, handling, packaging, and shipping of tritium and tritiated wastes. It includes discussions and advice on compliance-based issues and adds insight to those areas that currently possess unclear DOE guidance. It is intended to be a "living document," being revised periodically. For example, planning for and implementing contamination control as part of normal operation and maintenance activities is an important function in any tritium facility. The best practices from around the complex are presently being accumulated for inclusion in the next revision of this Handbook. Likewise, it is planned that the next revision will include a section on training issues for tritium operators and maintenance personnel.

1.3 Applicability

DOE facilities range from small radiological facilities engaged in operations using a few millicuries (mCi) up to 16,000 Ci of tritium; to large-scale facilities referred to as Non-Reactor Nuclear Facilities, using greater than 16,000 Ci (1.6 grams) of tritium. Guidance in this handbook is applicable to any scale of operations.

Some sections of this handbook resulted from consensus agreement between DOE's Tritium Focus Group members and the authors, representing the views of the Office of Nuclear and Facility Safety, EH-3, an organization within the Office of Environment, Safety and Health at DOE Headquarters. Other sections are strictly the viewpoint of the Office of Nuclear and Facility Safety. This office solicits comments and active discussion of the handbook content in order to improve the handbook on its next revision.

1.4 Referenced Material for Further Information

- DOE O 420.1, "Facility Safety"
- DOE G 420.1/B-0, "Implementation Guide for use with DOE Orders 420.1 and 440.1, *Fire Safety Program*"
- DOE G 420.1-X, "Implementation Guide for Non-Reactor Nuclear Safety Design Criteria and Explosives"
- DOE G 420.1-Y, "Implementation Guide for the Mitigation of Natural Phenomena Hazards for Non-Nuclear Facilities"
- DOE O 435.1, "Radioactive Waste Management"
- DOE P 450.4, "Safety Management System Policy"
- DOE G 450.4-1, Volumes 1 and 2, "Integrated Safety Management System Guide, Revision 0"
- DOE O 460.1A, "Packaging and Transportation Safety"
- DOE G 460.1-1, "Implementation Guide for Use with DOE O 460.1A"
- DOE O 460.2, "Departmental Materials Transportation and Packaging Management"
- DOE M 474.1-2, "Manual for Nuclear Materials Management and Safeguards System Reporting and Data Submission"
- DOE Order 5400.5, "Radiation Protection of the Public and Environment"
- DOE Order 5480.23, "Nuclear Safety Analysis Reports"
- DOE-EM-STD-5502-94, "Hazard Baseline Documentation"
- DOE Order 5610.12, "Packaging and Transportation of Nuclear Components"
- DOE Order 5633.3B, "Control and Accountability of Nuclear Materials"
- DOE Order 5820.2A, "Radioactive Waste Management"
- DOE-STD-1020-94, "Natural Phenomena Hazards Design and Evaluation Criteria for Department of Energy Facilities," including Change Notice 1, January 1996
- DOE-STD-1021-93, "Natural Phenomena Hazards Performance Categorization Guidelines for Systems, Structures, and Components," including Change Notice 1, January 1996
- DOE-STD-1022-94, "Natural Phenomena Hazards Characterization Criteria," including Change Notice 1, January 1996
- DOE-STD-1023-95, "Natural Phenomena Hazards Assessment Criteria," including Change Notice 1, January 1996
- DOE-STD-1027-92, "Hazard Categorization and Accident Analysis Techniques for Compliance with DOE Order 5480.23, Nuclear Safety Analysis Reports," including Change Notice 1, September 1997
- DOE-STD-1120-98, "Integration of Environment, Safety, and Health into Facility Disposition Activities"
- DOE-STD-3009-94, "Preparation Guide for U.S. DOE Nonreactor Nuclear Facility Safety Analysis Reports"
- DOE-HDBK-1105-96, "Radiological Training for Tritium Facilities"
- DOE-HDBK-1079-94, "Primer on Tritium Safe Handling Practices"
- DOE-HDBK-3010-94, "Airborne Release Fraction/Rates and Respirable Fractions for Nonreactor Nuclear Facilities"
- DOE/TIC-11268, "A Manual for the Prediction of Blast and Fragment Loading of Structures"
- ANS 14-1994, "Internal Dosimetry Standards for Tritium"
- ASCE 7-95, "Minimum Design Loads for Buildings and Other Structures"
- 10 CFR 20, "Standards for Protection Against Radiation"
- 10 CFR 71, "Packaging and Transportation of Radioactive Material"
- 10 CFR 830, "Nuclear Safety Management"

- 10 CFR 835, "Occupational Radiation Protection"
- 40 CFR 261, "Identification and Listing of Hazardous Waste"
- 40 CFR 262, "Standards Applicable to Generators of Hazardous Waste"
- 40 CFR 302.4, "Designation of Hazardous Substances"
- 49 CFR 172, "Hazardous Materials Table, Special Provisions, Hazardous Materials Communications, Emergency Response Information, and Training Requirements"
- 49 CFR 173, "Shippers – General Requirements for Shipments and Packagings"
- 49 CFR 177, "Carriage by Public Highway"
- 49 CFR 178, "Specifications for Packaging"
- 62 FR 62079, Joint NRC/EPA Guidance on Testing Requirements for Mixed Radioactive and Hazardous Waste, November 20, 1997
- IAEA Technical Report Series #324, "Safe Handling of Tritium"
- IAEA-SM-181/19, "Estimates of Dry Deposition and Plume Depletion over Forests and Grassland"
- ISO 7503-2, "Evaluation of Surface Contamination – Part 2: Tritium Surface Contamination"
- Office of Nuclear and Facility Safety Technical Notice 94-01, "Guidelines for Valves in Tritium Service"
- OSWER 9928.4-03, Waste Analysis at Facilities that Generate, Treat, Store, and Dispose of Hazardous Wastes: A Guidance Manual, April 1994
- Westinghouse Savannah River Company, WSRC-TR-94-0596, Titanium for Long Term Tritium Storage (U), December 1994.

2.0 TRITIUM

Isotopes are elements that have the same atomic number (same number of protons in the nucleus) but of different atomic mass (total number of protons plus neutrons in the nucleus). There are three isotopes of hydrogen. Ordinary hydrogen, referred to as protium (${}^1_1\text{H}$, atomic mass of 1), is the most abundant element in the universe and has one proton in the nucleus. Heavy hydrogen, referred to as deuterium (${}^2_1\text{H}$, or D, atomic mass of 2), makes up about 0.015 percent of the hydrogen, and has one proton and one neutron in the nucleus. Radioactive hydrogen, referred to as tritium (${}^3_1\text{H}$, or T, atomic mass of 3), has one proton and two neutrons in the nucleus. Refer to DOE-HDBK-1079-94 and the IAEA Guide on Safe Handling of Tritium for basic information on tritium, its properties, and compounds.

2.1 Radioactive Properties

Tritium is a beta emitter. It decays to ${}^3\text{He}$ by emitting a beta particle (electron) and a neutrino from one of the neutrons in the nucleus. The energy of the beta particle varies from 0 to 18.6 kilo-electron-volts (keV) with an average energy of 5.69 keV. For scientific purposes, the generally accepted value for the half-life of tritium, as measured by Mound Laboratories, is 12.323 ± 0.004 years (4500.88 ± 1.46 days). For DOE accountability purposes, the half-life of tritium, as stated in DOE M 474.1-2, Figure IV-2, is 12.33 ± 0.06 years. Figure 2-1 shows the rate of decay of one mole of tritium over six half-lives.

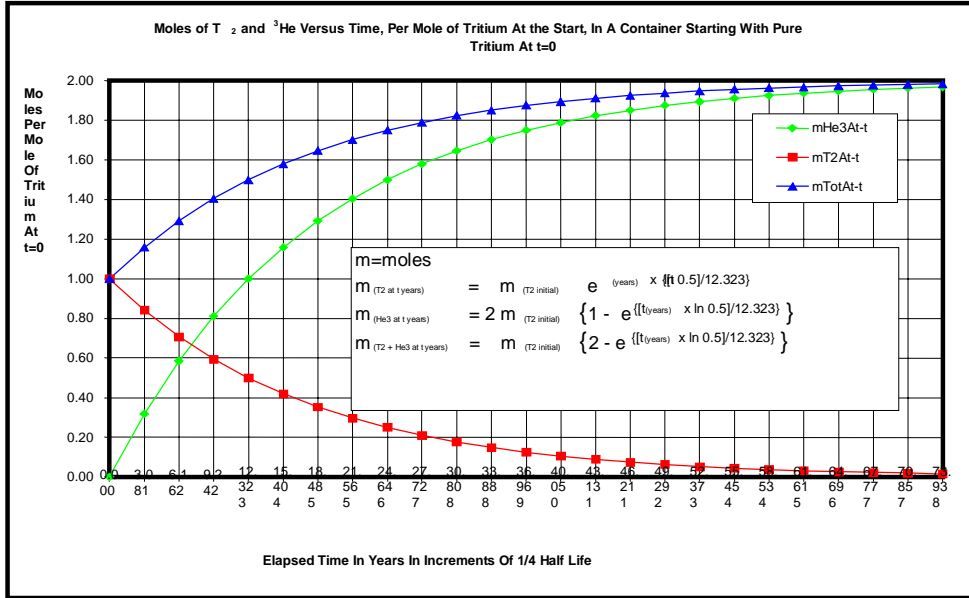

FIGURE 2-1. Rate of tritium decay of one mole of tritium

2.2 Physical Properties

Tritium gas is colorless, odorless, tasteless, and radioactive. It decays to ³He, a monatomic gas, by emitting an electron and neutrino from the nucleus. Tritium has a high coefficient of diffusion. It readily diffuses through porous substances such as rubber and can also diffuse through metals.

As tritium decays in a container of constant volume at a constant temperature, the tritium partial pressure decreases and the partial pressure of ³He increases. The pressure in the container approaches twice that of the original container pressure. The rate of pressure change over time is shown in Figure 2-2.

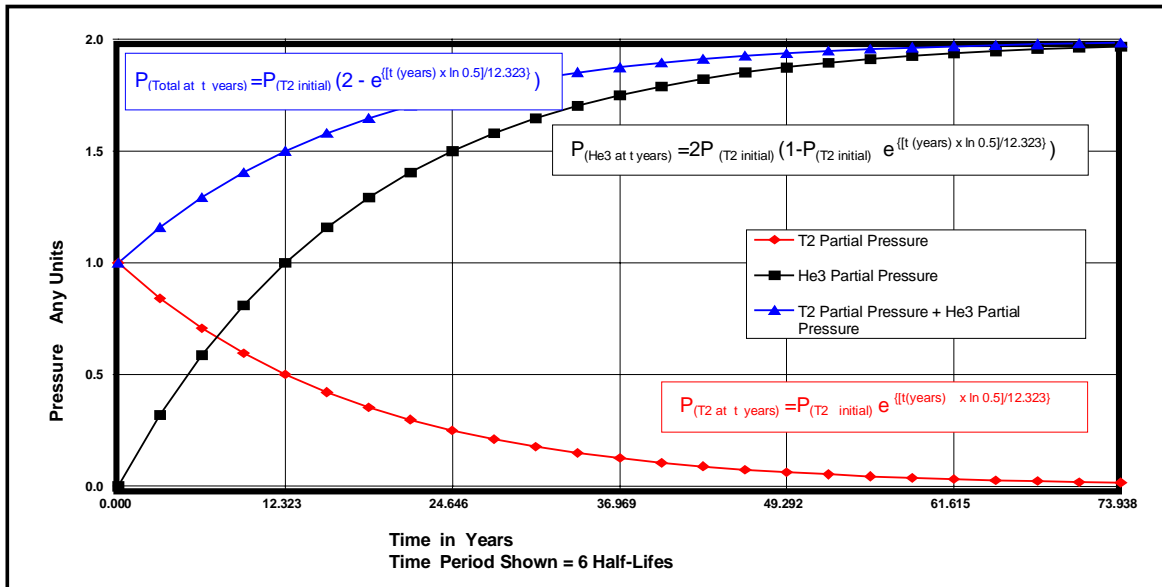

FIGURE 2-2. Pressure versus time in a container of tritium

Other properties of tritium are listed below. Additional characteristics are given in Appendix A.

- Atomic Weight = 3.01605
- Gram Molecular Weight = 6.03210
- Diameter of a tritium atom (approximate) = 1.1 Angstroms
- Dissociation energy, T_2 to $2T$ = 4.59 eV
- Ionization energy, T to $T^+ e^-$ = 13.55 eV
- Half Life = 12.323 +/- 0.004 years

In this handbook, tritium in the form of the oxide (HTO, DTO, and T_2O), unless otherwise specified, is HTO. Likewise, tritium in its elemental form (HT, DT, and T_2) is HT.

2.3 Chemical Properties

The electronic configuration of tritium is the same as protium and deuterium. The chemical properties of the isotopes are also the same. The rates of reaction vary for the different isotopes due to the difference in the atomic masses. Additionally, the energy provided by the radioactive decay of tritium provides the activation energy required so that some reactions will occur with tritium that will not occur with deuterium or hydrogen.

Hydrogen is present in almost all materials. If tritium is present in a material containing hydrogen, the tritium atoms will exchange with hydrogen atoms to form a tritiated molecule of the material.

2.4 Biological Properties

The body has no need for elemental hydrogen, deuterium, or tritium and does not readily absorb H_2 , HT, HD, D_2 , DT, or T_2 from inhaled gases or through the skin. A small fraction of the inhaled hydrogen isotopes, in gaseous form, is not exhaled, but is dissolved in the blood stream and then exhaled after a few minutes.

Tritium in the form of water (HTO, DTO, and T_2O) is adsorbed through the skin and in the lungs from inhaled gases. Tritium in water form is readily retained in the body and remains with a biological half-life of approximately 10 days. Due to the body's ready adsorption of tritium in the form of tritiated water, exposure to tritiated water in air is up to 25,000 times more hazardous than exposure to gaseous tritium (HT, DT, and T_2).

The Derived Air Concentration (DAC) for tritium is the airborne concentration that, if inhaled over a one-year period, would produce approximately a 5-rem dose to the "average" worker. The DAC is derived by the formula:

$$DAC = ALI/2400$$

where DAC = derived air concentration ($\mu\text{Ci}/\text{m}^3$)
 ALI = annual limit of intake (μCi)
 2400 = breathing volume for the average worker over 1 year in m^3
 = $.02 \text{ m}^3/\text{min} \times 60 \text{ min}/\text{hr} \times 40 \text{ hr}/\text{wk} \times 50 \text{ wk}/\text{yr}$

The DACs for elemental tritium and tritiated water [1] are listed in Table 2-1.

TABLE 2-1. Derived air concentrations for tritium and tritiated water

	$\mu\text{Ci/ml}$	Bq/m^3
HT	5E-01	2E10
HTO	2E-05	8E05

Unlike the situation for oxide and elemental, DACs for tritides (e.g., titanium tritide or hafnium tritide) are currently not defined in relevant regulations and, therefore, the process for radiation posting at 10 percent of the DAC level cannot be finalized for these tritiated compounds. The Office of Worker Protection Programs and Hazard Management within the Office of Worker Health and Safety (EH-5) and Environmental Management's Office of Safety and Health (EM-4) at DOE Headquarters are currently pursuing this issue, and a white paper, entitled *Workplace Indicators and Bioassay Limitations When Dealing With Stable Metal Tritides* (SMTs), was authored at Mound in September 1998. The Mound paper uses the terms stable and unstable to refer to the measure of the degree of tritium releasability from the metal. Easily releasable tritium is unstable, and is not a workplace monitoring or bioassay problem, as the tritium is more readily released as elemental or oxide. The tritides in which the tritium is difficult to release, or stable, are the topic of interest here. The biological effect resulting from these tritides is also not as well understood or modeled as those from oxides and elemental. The biological half-life of some tritides is at least an order of magnitude higher than oxide (see Appendix A-3). Tritium that is adsorbed or contained within respirable particulates (e.g., TiT_2 , or tritium gas in glass microspheres) presents unique dosimetry problems. The physical configuration of such material will affect the uptake, distribution, retention of the tritium, and will also affect the amount of energy deposited from each transformation. Other complexities (e.g., production of bremsstrahlung radiation) may have to be considered.

The possible dose pathways from inhalation of tritiated particulates are direct irradiation of the surrounding tissue; irradiation of the surrounding tissue by bremsstrahlung from the particle; uptake of any tritium oxide (HTO) contamination from the surface of the particle; and absorption (leaching) of tritium from the particle into the bloodstream.

The distribution and retention of tritiated particulates is largely dictated by the chemical and physical characteristics of the particles. For example, to gain a perspective on this issue, distribution and retention of inhaled TiT_2 has been modeled using a modification of the ICRP-30 Respiratory Tract Model with modified deposition fractions and compartmental half-lives of several hundred days. [2]

The factors, which affect the distribution and retention of such particulates, can act to both reduce and enhance the dose received per unit intake. For example, a very large fraction of inhaled activity is quickly eliminated from the body if the particle size distribution is relatively large. The small residence time, coupled with the effective encapsulation of the tritium activity and the short range of the beta particle emitted, all lead to a significant reduction in dose per unit intake (not uptake). Conversely, a postulated or observed long residence time in the lungs may lead to significant lung doses.

Due to the high degree of self-absorption of beta energy that takes place within the particle, only a very small fraction of the beta energy from each transformation is expected to escape the particle. It has been estimated [3] that this self-absorption may reduce the effective dose by as much as a factor of 2,000. Additionally, macrophages are expected to envelop particles in the lungs and add tissue shielding around the particle.

The contribution to dose from bremsstrahlung has been estimated. [2-3] Although this contribution is probably relatively small, it should be considered in the evaluation of lung doses from significant intakes of tritiated particulates.

Recently, estimates of effective doses from inhalation of various types of tritiated particulates were made [4]. These estimates are based on in-vitro and animal (rat) studies with titanium tritide. The assumption is made that the tritium, once dissolved, has the same distribution and retention as HTO in the body. The dose conversion factors (DCF) calculated for such intakes in adults are listed in Table 2-2.

TABLE 2-2. ICRP-71 dose conversion factors for inhalation of tritiated particulates

Lung Absorption Type*	DCF (Sv/Bq inhaled)	DCF (rem/ μ Ci inhaled)
Fast	6.2 E-12	2.3 E-05
Moderate	4.5 E-11	1.7 E-04
Slow	2.6 E-10	9.6 E-04

*Based on ICRP-66 Respiratory Tract Model and ICRP 60 Tissue Weighting Factors

The dose from inhalation of tritiated particulates must be evaluated on a case-by-case basis. In general, as with any suspected intake of tritium, urine samples should be collected. In the event of a suspected significant exposure of tritiated particulates, collection of early (first few days) fecal samples should be considered. Inhaled particulates are expected to be eliminated via this route. Cases involving inhalation of metal tritides have occurred in which significant tritium was seen in the feces, but not in the urine [5]. Collection and analysis of fecal samples (analysis based on fecal sampling must be cognizant of particle matrix absorption effects) allows confirmation of intake and may give information regarding the fractional uptake.

2.5 Preferred Forms

Most tritium in the DOE complex exists as a gas, in the form of tritiated water, or as a metal tritide. The preferred form of tritium is dependent upon its use in a process, length of storage, or its classification as a waste.

2.5.1 Characterization of Tritium Forms

2.5.1.a Gaseous Tritium

The use, transfer, storage, and shipment of gaseous tritium at or near atmospheric pressure has a long history in the DOE complex and has been safely used for over thirty years. Gaseous tritium at or near atmospheric pressure occupies 22.414 L/mole at 0° C, and approximately 24.2 L/mole at room temperature, and requires approved packages for shipment in either Type A or B quantities. If the containers are not properly designed or if they are damaged, the gas can leak from the container into the environment.

Gaseous tritium at ambient pressure is easily handled by most gas handling systems and is a good source for general-purpose use. At low pressure and temperature, the tritium does not penetrate deeply into the container wall. Helium and tritium embrittlement of the container wall is not a significant issue at low pressures even after several years of exposure. As tritium decays, the pressure in the container increases (see Figure 2-2) due to the generation of the monatomic gas

^3He . This pressure increase, at most, would only be double the initial pressure. This factor should be considered during the initial design of the vessel so it does not become an issue.

Gaseous tritium at high pressure takes up less space but is more difficult to contain in part due to the potential for tritium and helium embrittlement of the vessel materials. This embrittlement increases the probability of a tritium leak or catastrophic container failure. Unloading high-pressure gas requires specifically designed systems and experienced, skilled operators.

2.5.1.b Metal Tritides

Metal tritides reduce the overall volume of the stored tritium, but some of the finely divided metals used are pyrophoric. Some metals form low melting point alloys with the materials used in the construction of the metal tritide containers. Others require extremely high temperatures in order to recover tritium from the material.

2.5.1.c Tritiated Water

Tritium in the form of T_2O may be difficult to store for long periods due to its corrosive properties. Classified experiments with T_2O indicate that pure T_2O is corrosive. This corrosiveness is likely due to tritium oxide generating free radicals (OH^\cdot) from radiolytic decomposition of water in addition to extra energy from beta decay impinging on surrounding molecules. Additionally, pure T_2O , like distilled H_2O , will dissolve many materials. No data currently exist that quantify the degree of corrosiveness; therefore, there is no basis to definitively state that the U. S. Environmental Protection Agency (EPA) threshold of corrosivity (i.e., a characteristic of hazardous waste), defined in Code of Federal Regulations 40 CFR 261.22, is not exceeded. The authors believe, however, that only a high-purity product, and not waste, would have a reasonable chance of exceeding this threshold. A broader discussion of the relationship between tritiated water and hazardous wastes is contained in Section 3.1.3.

Dilute tritiated water recovered from tritium removal systems has also proven to be corrosive and difficult to contain. In a severe case, storage of tritiated water recovered from tritium removal systems in liquid form at concentrations as low as a few curies per milliliter has corroded through the weld area of stainless steel vessels after only a few days of exposure. In this specific example, it is probable that the extreme corrosive nature of this dilute tritiated water was due, in large measure, to chlorine contamination of the catalyst in the tritium removal system. This corrosion is evidently inhibited by absorption of the tritiated water on clay or in molecular sieve material.

Figure 2-3 provides a comparison of the various concentrations of tritiated water found throughout the nuclear industry.

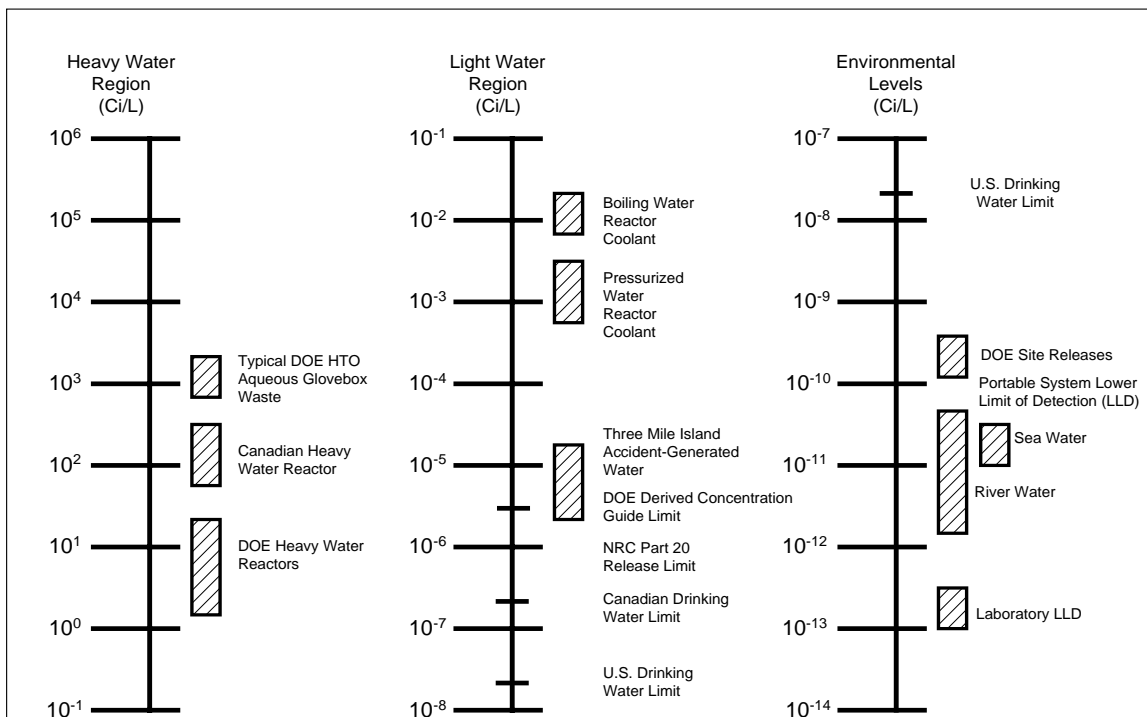

FIGURE 2-3. Comparison of aqueous tritium levels found in the nuclear industry

2.5.2 Identity of Common Forms

Tritium is usually supplied in gaseous or uranium tritide form. Other forms are also available but are not in common use for bulk shipment.

2.5.2.a Gas

In gaseous form, tritium is usually supplied at a purity of 90 to 95 percent tritium (99 percent in research applications) with deuterium and protium as the primary impurities.

The use of metal tritide storage beds is one of the most convenient ways of handling tritium. The metal tritide beds have different operating parameters and characteristics, and there are advantages and disadvantages in use of the different materials.

2.5.2.b(1) Uranium

Uranium is currently the most useful material for general-purpose tritium storage beds. The equation form for the dissociation pressure of uranium tritide, deuteride, and hydride for the pressure in millimeters of mercury is, $P_{mm} = 10^{(-A/T + B)}$, where A and B are parameters listed in Table 2-3. Westinghouse Savannah River Company (WSRC) has determined that in the hydride transport vessel (HTV), for a uranium to tritium ratio of 1:2.9 in the HTV vessel, the equation is $P_{atm} = 10^{(-4038.2/T + 6.074)}$.

At room temperature, tritium in the presence of uranium powder forms uranium tritide. The tritium partial pressure in the bed is very low. As a result, at room temperature the bed acts as a vacuum pump that getters all of the hydrogen isotopes. The impurity gases that may be present, such as

^3He , N_2 , O_2 , or Ar, either remain in the overpressure gas in the bed or react with uranium to form stable compounds. Inert gases, such as Ar, will remain in the overpressure gas, and can be removed by pumping off with a vacuum pump after the pressure has stabilized; however, helium-3 cannot be pumped off without first heating the bed. N_2 and O_2 will react chemically with the uranium to form stable uranium compounds in the bed, and, therefore, cannot be pumped off at all. As the temperature of the bed is increased, the tritium partial pressure increases as a function of temperature. Depending upon the U:T ratio, it can reach a pressure of around 500 pounds per square inch absolute (psia) at 600°C. The tritium may be transferred into and out of manifolds, containers, etc., by heating the bed and then cooling it to room temperature. The general form of the equation for the dissociation pressure, P, in millimeters of mercury (mm) for uranium hydride, deuteride, and tritide is:

$$\log P_{\text{mm}} = -A/T + B$$

or

$$P_{\text{mm}} = 10^{-(A/T(K)) + B}$$

where T = temperature (K)

The values for A and B for hydrogen, deuterium, and tritium, determined by several different investigators, are listed in the following paragraphs, and the results are shown in Table 2-3 and plotted in Figure 2-4. Figure 2-5 is a plot of the general characteristics of uranium hydride, deuteride, and tritide.

TABLE 2-3. Dissociation pressure equation parameters for uranium hydride, deuteride, and tritide

Metal Tritide	Reference	Temperature Range (°C) Investigated	A (/Kelvin)	B	Temperature (°C) required to generate a pressure of 1 atmosphere
UH ₃	Spedding, et al.	260 to 430	4500	9.28	430
	Destriau & Seriot	243 to 412	4255	9.08	415
	Wicke & Otto	200 to 430	4450	9.20	434
	Mogard & Cabane	500 to 650	4480	9.20	435
	Libowitz & Gibb	450 to 650	4410	9.14	432
UD ₃	Spedding, et al.	unspecified	4500	9.43	414
	Destriau & Seriot	unspecified	4401	9.01	445
	Wicke & Otto	unspecified	4500	9.40	417
UT ₃	Flotow & Abraham WSRC	unspecified	4471	9.461	408
		unspecified	4038.2	6.074	unspecified

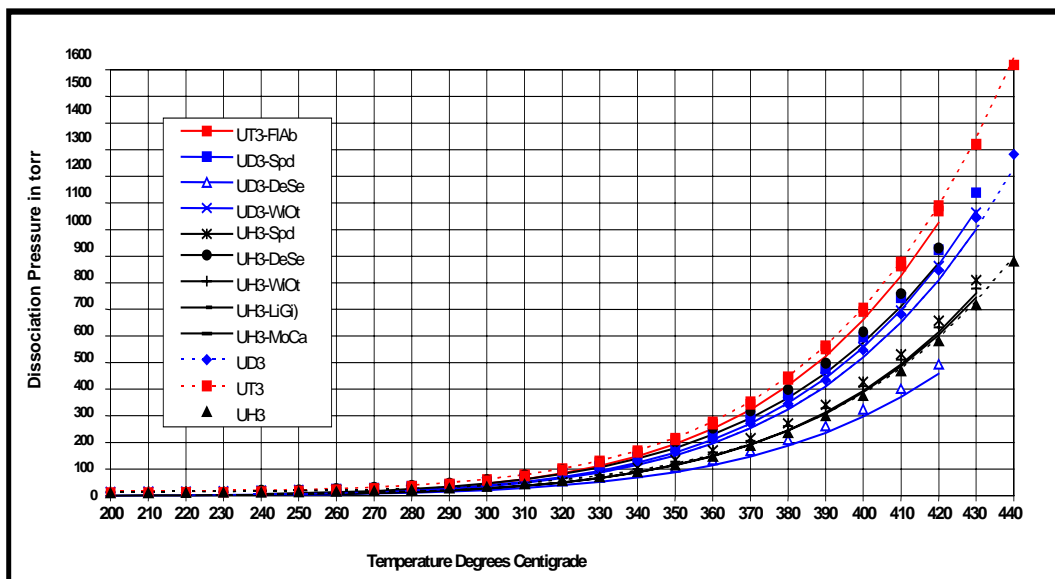

FIGURE 2-4. Dissociation pressure for uranium, hydride, deuteride, and tritide

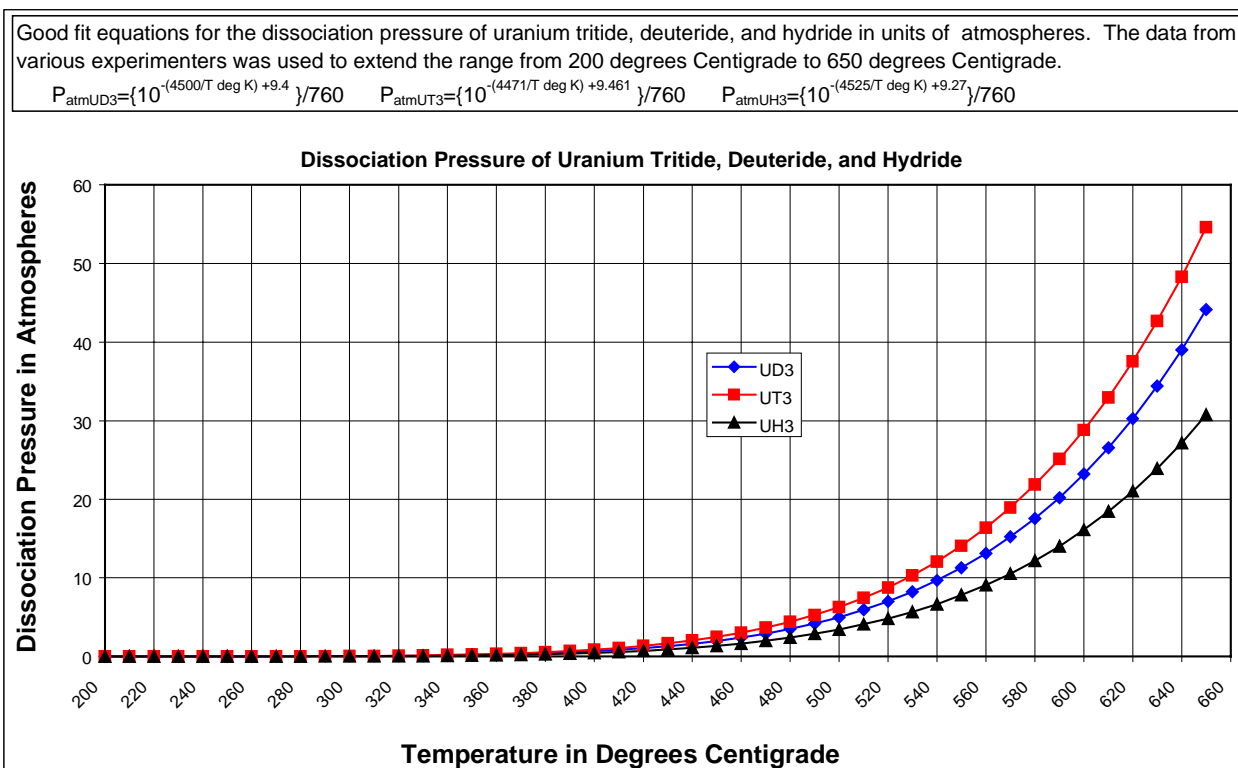

FIGURE 2-5. Plot of a good fit curve for the dissociation pressure of uranium hydride, deuteride, and tritide

Each time the tritium is cycled into the system manifolds it picks up impurity gases. These impurities collect in the bed overpressure gas and may be pumped off to remove them after each

heating/cooling cycle. Active impurity gases, such as oxygen and nitrogen, are irreversibly removed by reaction with the uranium.

Disadvantages to using uranium tritide beds are: 1) uranium powder is pyrophoric; 2) the generation of significant tritium pressure requires a high temperature that results in permeation of tritium through the vessel wall; and 3) the capacity is also permanently reduced by exposure to active impurity gases.

2.5.2.b(2) Palladium

Palladium is a metallic element of group 8 in the Periodic Table. The symbol for palladium is Pd, the atomic number is 46, the atomic weight is 106.42, and the melting point is 1554.9°C.

At room temperature, palladium absorbs up to 900 times its own volume in hydrogen. It diffuses easily through heated palladium; this is one means of purifying the gas. Finely divided Pd is a good catalyst, and is used for hydrogenation and dehydrogenation reactions. Palladium metal is used in dentistry, as an alloy in making jewelry, and in making surgical instruments, watches, and electrical contacts.

Palladium powder is currently the second most used material for general-purpose tritium storage beds. Palladium can be obtained in powdered form and loaded directly into the container used for the metal tritide bed. Palladium was used extensively at both LLNL and SNLL in the tritium storage beds.

When the tritium is exposed to the powder, it dissolves in the palladium powder with a maximum Pd:T ratio of approximately 0.7. Palladium powder is not pyrophoric, but it has a higher tritium partial pressure than uranium at room temperature.

At room temperature, tritium, deuterium, and protium dissolve in the palladium powder and the tritium partial pressure in the gas over the powder is approximately 50 torr. The over pressure increases as a function of temperature. As the temperature of the palladium is increased by heating the bed, the tritium partial pressure increases as a function of the temperature and reaches a pressure of around 750 psia at 350°C. The general form of the equation for the dissociation pressure, P, in millimeters of mercury (mm) for palladium hydride, deuteride, and tritide is:

$$\log P_{\text{mm}} = (-A/T + B)$$

or

$$P_{\text{mm}} = 10^{(-A/T + B)}$$

Where T= temperature (K)

The values for A and B for hydrogen and deuterium determined by different investigators are given in Table 2-4, and the equations developed by the different experimenters over the temperature range they investigated are plotted in Figure 2-6.

TABLE 2-4. Dissociation pressure equation parameters for palladium hydride and deuteride

Metal Tritide	Reference	Temperature Range (°C) Investigated	A	B
PdH _x	Gillespe & Hall	0 to 180	1835.4	7.3278
	Gillespe & Hall	200 to 300	1877.82	7.483
	Ratchford & Castellan	unspecified	2028.2	7.9776
	Wicke & Nernst	-78 to 175	2039	7.65
PdD _x	Gillespe & Downs	to 300	1696.11	7.5138
	Wicke & Nernst	unspecified	1940	8.00

The ³He generated as a result of decay of the tritium absorbed in the palladium is trapped in the palladium and is not released until the bed is heated or until the T:³He ratio reaches a particular value. ³He generated as a result of decay in the overpressure gas is not absorbed in the palladium and remains in the overpressure gas. Most impurities do not react with, and are not gettered by, the palladium powder. These impurities accumulate in the overpressure gas as the bed is used to support operations.

The generation of significant pressure at low temperature (750 psia at 350°C) is the primary advantage of palladium. The primary disadvantage of palladium is the high partial pressure of tritium over the powder at room temperature (50 torr at room temperature).

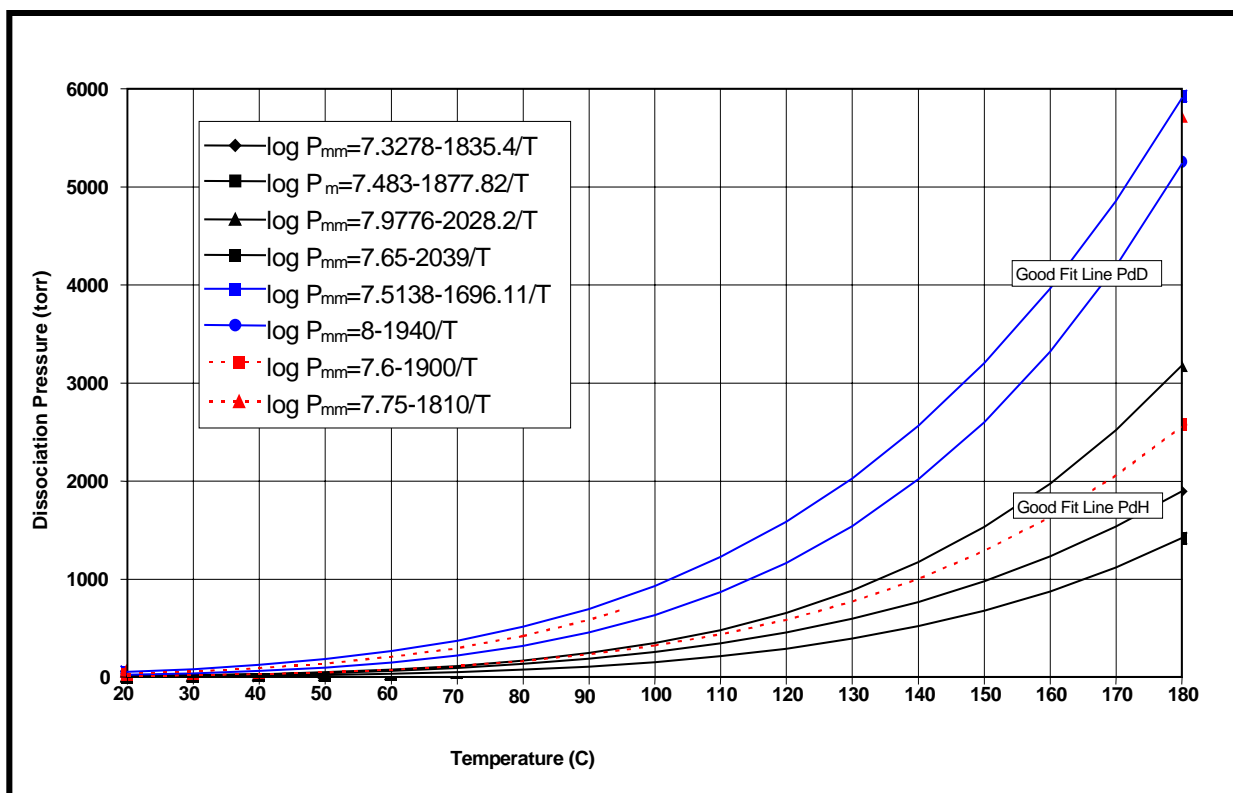

FIGURE 2-6. Dissociation pressure of palladium hydride and deuteride

2.5.2.b(3) Titanium

Titanium is a metallic element in group 4 of the Periodic Table. The symbol is Ti, the atomic number is 22, the atomic weight is 47.90, and the melting point is 1660°C. It is a low-cost metal, and can absorb and store tritium in a compact solid form at a tritium pressure of approximately 1E-7 torr.

Titanium hydride, TiH₂, in powder form, is a black metallic dust that is less prone to spontaneous ignition in air than the parent metal. Finely divided titanium hydride is reported to ignite at 440°C and its dust is an explosion hazard, which dissociates above 288°C. Titanium hydride is used in powder metallurgy, hydrogen production, foamed metals, glass solder, and refractories, and as a gas getter in the electronics industry. Titanium tritide in solid or massive form is stable in air for extended periods of time. Titanium retains the decay helium up to a concentration of 0.3 He atom per Ti atom. Both SRS [6] and Ontario Hydro [7-11] have selected titanium as their long-term storage medium. The SRS titanium beds have an expected useful life of less than 10 years, while the Ontario Hydro beds are expected to be in operation for well over 20 years. The Canadians are not space-restricted, and therefore do not load their beds to the degree that SRS does. Additionally, longer times to maximum helium retention ratio (0.3 He/Ti) can be achieved by diluting the tritium concentration with deuterium or protium.

2.5.2.b(4) Zirconium

Zirconium is a metallic element of group 4 in the Periodic Table. The symbol for zirconium is Zr, the atomic number is 40, and the atomic weight is 91.22. Zirconium is flammable as a powder and melts at 1850°C. Zirconium is a hard, lustrous, grayish metal that is strong and ductile, and is used in alloys, pyrotechnics, welding fluxes, and explosives.

Zirconium hydride ZrH₂ is a flammable gray-black powder and is used in powder metallurgy, nuclear moderators, and as a reducing agent. Finely divided zirconium hydride suspended in air will ignite at 430°C. Zirconium hydride contains about twice as many hydrogen atoms per unit of volume as liquid hydrogen. Massive zirconium hydride is stable in air for extended periods of time at temperatures below 600°C.

Certain DOE radioactive zirconium fines (which are destined for disposal) are managed as D001 mixed ignitable wastes. These radioactive zirconium fines are pyrophoric under 40 CFR 261.21(a)(2) – i.e., they are capable of causing fire through friction. If zirconium used for tritium storage beds is destined for disposal (i.e., constitutes a waste), the RCRA hazardous waste characteristic of ignitability must be analyzed. A broader discussion of RCRA hazardous waste is contained in Section 3.1.3.

2.5.2.b(5) Società Apparecchi Elettrici e Scientifici (SAES) Getters

During the past several years, investigations have been conducted concerning the use of SAES Getters to remove tritium from tritium-contaminated gaseous waste streams. These investigations have concentrated on getters that cracked the gases containing tritium and removed the resulting free tritium from the gas stream. The primary advantage of these getter systems is that tritium is not converted by the tritium removal system to the more radiotoxic tritiated water. Additionally, the tritium can be recovered in gaseous form from the getter, purified, and reused.

The materials being tested include those manufactured in the form of pressed pellets that can be used in low pressure drop packed bed reactors designed for the size required by the application

flow rate and lifetime requirements. The basic strategy currently being implemented in prototype systems is to crack the molecules on a hot getter and remove the non-tritiated reactive impurities that interfere with the performance of the hydrogen gettering alloys. Following purification, the gas is passed through a hydrogen gettering bed to remove the hydrogen isotopes from the gas stream.

2.5.2.b(6) LaNi₅ Based Alloys

The use of lanthanum-nickel hydrides has been a continuing topic of interest, and as recently as 1997, promising results for hydrogen storage have been reported ("LaNi₅ Intermetallic Hydride," extracted from *State-of-the-Art Review of Hydrogen Storage in Reversible Metal Hydrides for Military Fuel Cell Applications*, Gary Sandrock, Ph.D., for the Department of the Navy, Office of Naval Research, N00014-97-M-0001, July 24, 1997). Promising research results were also reported in the literature in 1988 ("Hydrogen Isotope Sorption Properties of LaNi₃Mn₂ Alloy as a Candidate for the Tritium Storage Material," T. Ide et al., Sumitomo Heavy Industries, Ltd. and H. Yoshida et al., Japan Atomic Research Institute, published in *Fusion Technology*, September 1988). Earlier research at Mound, however, in the 1970s and early 1980s indicated that lanthanum-nickel-based alloys were not appropriate for tritium service due, in part, to disproportionation. When cycled, the LaNi₅ had a tendency to separate to form the parent metals (La or Ni) or different alloys. The disproportionation tended to change the pressure, concentration, and temperature properties of the metal/alloy mix and increase the quantity of tritium bound in the heel that was not easily recoverable.

Further investigations will be needed to better ascertain the capabilities of LaNi alloys for tritium service.

2.5.2.c Absorbed Water

Molecular sieve material is used in tritium removal systems for removal of water contaminated with tritium. Systems such as tritium removal systems, effluent recovery systems, and cleanup systems remove tritium from a gas by cracking the tritium-containing components on a heated precious metal catalyst. The free tritium then combines with oxygen in the gas stream to form tritiated water. The gas stream is then cooled to room temperature, and the water contained in the gas stream, including the tritiated water, is removed by a molecular sieve trap.

A molecular sieve will hold about 18 percent water by weight, and the sieve may be regenerated to remove the water so it can be reused. The issue of flammability limits of these containers is discussed in Section 3.1.2. Tritiated water absorbed on molecular sieve is not corrosive and may be stored in this way for long periods without damage to the container wall.

Water contaminated with HTO is also stored on clay. The common method of solidification of tritium-contaminated wastewater for disposal is to solidify the water on clay so that it can be classified as solid waste. Clay will hold approximately 60 percent water by volume. Waste disposal sites generally require the use of 100 percent more clay than required to solidify the water, and, as a result, the water is generally limited to 30 percent of the volume of the clay for waste solidification purposes. Water absorbed on clay is not corrosive and may be stored for long periods without damage to the container wall.

2.5.3 Summary

2.5.3.a Best for Storage Conditions

The decision on storage media is a function of the storage length and frequency of unloadings. Media range from gas (short time frame, many movements) to titanium (long time frame, few or no movements) with other media (e.g., uranium) in between. Although the preferred form for storage is a metal tritide and the least desirable form is a liquid, there are always exceptions to this rule. Factors to be considered include:

Solid (Metal Tritides): Unless already in solid form, tritium is not readily available as a solid metal tritide and requires conversion before storage. Metal tritides can store large quantities of tritium without occupying large volumes, but the storage containers are more complex than gaseous storage containers. Depending upon the metallic tritide chosen for storage, there are both advantages and disadvantages. Titanium tritide is very stable, even when exposed to air, but it is more difficult to recover tritium from the titanium than from other metals. Stored as uranium tritide, the tritium can be easily and quickly recovered and provides for the removal of most impurities that might accumulate during storage. However, uranium powder is also pyrophoric, and starts releasing ^3He after a few months.

Liquid (T_2O): Tritium is not readily available in water form and requires conversion before storage. It is up to 25,000 times more hazardous in oxide form than in elemental form. It takes very little space, but is difficult to store due to the corrosivity of the water. The tritiated liquid can be solidified on clay, molecular sieves, or polymers prior to disposal. It may also be converted to its gaseous form for storage purposes. In either case, the final decision should be based on the quantity of tritium and the tritium concentration of the water to be stored.

Gas (T_2): Tritium is readily available in gaseous form. A great deal of experience already exists on the design of gaseous tritium storage systems. As a gas it takes up more volume than as a liquid or solid, and can be easily released to the environment if the tritium container is breached. Gas also presents a flammability vulnerability.

2.5.3.b Best for Operations/Process

Solid (Metal Tritides): When used as a gas in research where tritium is issued and returned as a gas, there are advantages to the use of uranium beds for storage. The heating/cooling cycle used to store and recover tritium from the bed results in routine removal of the ^3He and other impurities from the tritium supply. It can be reused in other processes at reasonably high purity. Additionally, storage as a metal tritide allows the bed to be used as a pressure generator and, in some cases, eliminates the need for mechanical pumps.

Liquid (T_2O): Unless the process itself uses tritium in the form of water, there are no advantages to storage of tritium in liquid form for operations.

Gas (T_2): Tritium is primarily used in gaseous form, purified in gaseous form, assayed in gaseous form, and is more useful in this form than any other form. As a result, storage in gaseous form for operations is appropriate.

2.5.3.c Best for Disposal Conditions

Disposing of tritium in the form of a liquid waste or gaseous waste is difficult. Generally speaking, waste tritium is converted to solid form so that the material can be disposed of as a solid low-level (radioactive) waste, assuming there is no RCRA hazardous component.

Solid (Metal Tritide): It is possible to dispose of gaseous tritium by converting it to a solid metal tritide. However, the disposal site requires that the metal tritide not be pyrophoric. If it is in particulate form, the metal tritide must be contained to meet disposal site requirements.

Liquid (T₂O): If the waste is in gaseous form, the tritium is normally removed from the gas mixture and is reused. If the concentration of tritium in the waste gas is too low to make recovery of the tritium economically worthwhile, the waste gas is sent to an effluent processing system where the tritium is removed before the gases are released to the environment. The current effluent processing systems remove tritium from the waste gas by converting it to water. The water is then solidified on molecular sieve, clay, mixtures of clay and cement, or Stergo superabsorbent (discussed in Section 8.1.4.b(2)), and is then packaged as solid waste and shipped to the disposal site.

Gas (T₂): Waste disposal sites generally will not accept packages containing pressurized gases or those in which a potential exists for generating 1.5 atmospheres (absolute) of pressure over time.

3.0 BASIC TRITIUM REGULATORY INFORMATION

Due to its more hazardous profile, most of the regulatory interest in tritium is concerned with the oxide form. Figure 2-3 pictorially illustrates various concentrations and regulatory set points. The radiological materials inventory for tritium accounting purposes may not coincide with the radiological materials inventory for safety analysis report (SAR) purposes, which may not coincide with the radiological materials inventory for Environmental Impact Statement (EIS) purposes. This is due to prescribed allowances for excluding various portions of the inventory, as discussed in Sections 3.1 and 3.3.

3.1 Tritium Accountability

3.1.1 Radiological Materials Inventory

The Atomic Energy Act describes three categories of materials: Byproduct, Source and Special Nuclear Material (SNM). There are also three categories of nuclear materials described in DOE Order 5633.3B, "Control and Accountability of Nuclear Materials": SNM, Source and Other. The order designates that tritium is an "Other" category material and is accountable nuclear material.

Tritium is accountable for DOE down to 0.01 grams. Items that contain tritium quantities of 0.005 grams or greater are rounded to the nearest 0.01 grams and become accountable items. Items that contain less than 0.005 grams round to zero and are not accountable items. For the purposes of accountability, the radiological materials inventory of tritium is the sum of the tritium quantities contained in the accountable items. This sum does not include any items that contain less than

0.005 grams of tritium or other items that are not part of the facility accountable nuclear materials inventory.

Quantities of tritium contained in waste may be part of the facility accountable nuclear materials inventory until it is removed from the facility to a waste accumulation area for storage or to a waste packaging area for packaging. Waste can also be put in a prescribed form, as specified in DOE Order 5633.3B. Individual waste items that contain at least 0.005 grams of tritium are accountable nuclear materials items and become part of the facility accountable nuclear materials inventory.

Tritium contained in water (H_2O or D_2O) used as a moderator in a nuclear reactor is not an accountable material.

DOE requires that a tritium facility establish material control and accountability systems to provide accurate nuclear materials inventory information. The facility tritium inventory and scrap levels of tritium must be minimized consistent with the operational needs and safeguards practices of the facility.

For each facility, a materials control and accountability program must be established for all nuclear materials on inventory, including those designated as uneconomical to recover. The facility materials control and accountability system should include the following:

- Accounting System Database
- Account Structure
- Records and Reports
- Physical Inventories
- Periodic Physical Inventories
- Special Inventories
- Inventory Verification/Confirmation Measurements
- Measurements and Measurement Control
- Organization
- Selection and Qualification of Measurement Methods
- Training and Qualification of Measurement Personnel
- Measurement Systems
- Measurement Control
- Material Transfers
- External Transfers
- Internal Transfers
- Material Control Indicators
- Shipper/Receiver Difference Assessment
- Inventory Difference Evaluation
- Evaluation of Other Inventory Adjustments
- Documentation and Reporting Forms
- Procedures and Requirements

3.1.2 EPA Maximum Contaminant Level for Tritium

The current National Primary Drinking Water Regulation (NPDWR) for beta- and photon-emitting radionuclides is 4 millirem (mrem)/year. The regulatory compliance level for tritium, corresponding to the 4 mrem/year level determined by EPA (40 CFR Part 141) is 20,000 pCi/L. By comparison,

the World Health Organization and Canadian levels are approximately 200,000 pCi/L (189,000 pCi/L for Canada and 210,000 pCi/L for the World Health Organization. These are based on a value of 10 percent of the public dose limits as calculated in accordance with ICRP-60 recommendations. [12]

EPA calculated a maximum contaminant level (MCL) for tritium of 20,000 pCi/L in 1976 based on values for worker exposure contained in Handbook 69, "Maximum Permissible Concentrations of Radionuclides in Air and Water for Occupational Exposure," published by the National Bureau of Standards in 1959 and amended in 1963. This calculation assumes that an extra dose resulting from organically bound tritium, equal to a 20 percent increase over that determined for worker exposure dose in Handbook 69, should be factored into the MCL. The resulting MCL (20,000 pCi/L) is based on not exceeding 4 mrem/year on a total body basis, and assumes a daily rate of ingestion of 2L of water.

In July 1991, EPA proposed revised MCLs for radionuclides based on its dosimetric model RADRISK, which included many of the concepts and assumptions included in the effective dose equivalent method (ICRP 30). In the proposed regulation, EPA determined that the MCL for tritium was 60,900 pCi/L. DOE provided comments to EPA suggesting that the appropriate value for the tritium MCL should be 80,000 pCi/L, based on dose to soft body tissues. This value is consistent with the Derived Concentration Guide (DCG) value in DOE Order 5400.5, "Radiation Protection of the Public and the Environment." Apparently, EPA used its RADRISK model to calculate the 60,900 pCi/L value, which differed from the models and parameters recommended by ICRP 30. The proposed regulation has not been finalized. Projections from EPA are that a re-proposed rule is expected no sooner than December 2000.

In early 1997, EPA prepared a Direct Final Rule that would have updated the methodology used in the 1976 final NPDWR. This methodology would be consistent with the method contained in ICRP 30 and Federal Guidance Report 11; i.e., the effective dose equivalent concept—rather than the "total body or organ dose equivalent" method used in 1976. This direct final rule would have retained the 4 mrem/year standard, which is based on daily ingestion of 2L of water and corresponds to a lifetime cancer risk of 10^{-4} . In April 1997, however, EPA determined that the Safe Drinking Water Act Amendments of 1996 contained a provision that would preclude EPA from promulgating a standard that results in increased risk, in the context of revising an existing standard. Although the direct final rule was described as a technical modification to the methodology used to calculate a regulatory compliance level, and that the basic standard (4 mrem/year) was unchanged, the concentration levels for many of the radionuclides would increase, thereby increasing risk. The level for tritium is the most dramatic example, since the change in methodology would increase the regulatory compliance level from 20,000 pCi/L to 86,000 pCi/L. To date, EPA has not promulgated this direct final rule.

It is the current understanding of the Office of Environment Safety and Health (EH's) that EPA is considering a risk-based approach to setting NPDWRs for radionuclides, rather than the dose-based approach currently followed. No decisions have been made. EH is not aware of any plan for providing an advance or draft rule for review and comment on this approach. If a risk-based approach were to be adopted, it is likely that the MCL for tritium would be on the order of 30,000 pCi/L rather than the 60,900 pCi/L proposed in 1991. A summary of the rule and proposals is given in Table 3-1.

TABLE 3-1. EPA maximum contaminant level for tritium

Rule	DOE Effects	MCL	Source
1976 Final Rule (41 FR 28404)	4 mrem/year Total Body or Organ Dose Equivalent	20,000 pCi/L	NBS Handbook 69
1991 Proposed Rule (56 FR 33050)	4 mrem/ year Effective Dose Equivalent	60,900 pCi/L	RADRISK (ICRP 30)
1997 Direct Final Rule (Never Issued)	4 mrem/year Effective Dose Equivalent	86,000 pCi/L	Federal Guidance Report #11

3.1.3 Reactor- Versus Accelerator-Produced Tritium

Under the implementing regulations of the Resource Conservation and Recovery Act (RCRA) [specifically at 40 CFR 261.4(a)(4)], source, special nuclear and byproduct material as defined by the Atomic Energy Act of 1954 (AEA) is excluded from the definition of solid waste (and thus, from the RCRA hazardous waste management requirements). The AEA definition of byproduct material includes “any radioactive material (except special nuclear material) yielded in or made radioactive by exposure to the radiation incident to the process of producing or utilizing special nuclear material.” Tritium produced in a reactor (i.e., through the use of special nuclear or source materials) meets the definition of “by-product” material; and, therefore, the waste streams derived from reactor-produced tritium are excluded from RCRA regulation (provided such waste streams do not also contain a RCRA hazardous waste component in addition to the by-product material component). Accelerator-produced tritium, on the other hand, does not qualify for this exclusion (since the tritium is produced by a linear accelerator, and does not involve the production or utilization of special nuclear materials or the extraction or concentration of source material).

Thus, for reactor-generated tritium waste to be considered hazardous waste, the waste stream also would have to contain a RCRA listed or non-tritium derived characteristic hazardous waste component. For accelerator-produced tritium waste streams (with only tritium, or tritium and other non-hazardous waste components), the waste stream would not be excluded from RCRA. However, unless such tritium wastes exhibit one of the characteristics of RCRA hazardous waste [ignitability, corrosivity, reactivity, or toxicity (40 CFR 261.21 - .24)], the waste streams would not need to be managed as a RCRA hazardous/mixed waste. Pursuant to the RCRA regulations, it is the responsibility of the generator of a waste to determine if that waste is subject to the hazardous waste requirements [40 CFR 262.11]. Categories of characteristic hazardous waste (and associated properties) that appear to have some potential to apply to certain accelerator-produced tritium wastes are as follows:

- Ignitability [40 CFR 261.21] – Ignitable wastes are solid wastes that exhibit any of the following properties: liquids with a flash point of less than 60°C (140°F); solids that are capable of causing fires through friction, absorption of moisture, or spontaneous chemical changes; ignitable compressed gases as defined in 49 CFR 173.300; or oxidizers as defined in 49 CFR 173.151.
- Corrosivity [40 CFR 261.22] – Corrosive wastes are solid wastes that exhibit any of the following properties: an aqueous material with pH ≤ 2 or ≥ 12.5 ; or a liquid that corrodes steel at a rate greater than ¼ inch per year at a temperature of 55°C (130°F).

- Reactivity [40 CFR 261.23] – Reactive wastes are solid wastes that exhibit any of the following properties: (1) they are normally unstable and readily undergo violent change without detonating; (2) they react violently with water; (3) they form potentially explosive mixtures with water; (4) when mixed with water, they generate toxic gases, vapors, or fumes in a quantity sufficient to present a danger to human health or the environment; (5) they are a cyanide or sulfide bearing waste which, when exposed to pH conditions between 2 and 12.5, can generate toxic gases, vapors, or fumes in a quantity sufficient to present a danger to human health or the environment; (6) they are capable of detonation or explosive reaction if subjected to a strong initiating source or if heated under confinement; (7) they are readily capable of detonation or explosive decomposition or reaction at standard temperature and pressure; (8) they are a forbidden explosive as defined in 49 CFR 173.51, or a Class A explosive as defined in 49 CFR 173.53 or a Class B explosive as defined in 49 CFR 173.88.

The discussion in Section 2.5.1.c provides a qualitative argument for the determination that for waste, the characteristic of corrosivity typically are not exhibited. However, little data are currently available to confirm whether or not the vapor space of some tritium containers (e.g. tritium oxide adsorbed on molecular sieves) would exhibit the hazardous characteristic of ignitability or reactivity over time due to radiolytic decay. As explained above, reactor-generated tritium waste streams that do not contain a hazardous waste component may be excluded from the RCRA hazardous waste regulations pursuant to 40 CFR 261.4(a)(4). This may be the case even if sufficient quantities of both hydrogen and oxygen are present to exhibit characteristics of ignitability or reactivity. This is based on a regulatory policy that EPA has applied in certain cases whereby residuals derived from the management of exempt or excluded waste retain the exemption or exclusion. [13-17] However (as indicated above), if a tritium waste (reactor- or accelerator-produced) also contains a distinct hazardous waste component, the waste stream should be managed as a radioactive mixed waste under the AEA and RCRA.

The application of RCRA to certain tritium waste streams may be subject to regulatory interpretation and enforcement discretion. With this in mind, it is recommended that determinations as to whether or not certain tritium wastes constitute RCRA hazardous waste be discussed and validated with the appropriate regulatory agency (i.e., the EPA Region or RCRA-authorized State agency). Section 8.2.2 provides a flow diagram and expanded discussion on this issue, in addition to the definitions and options for tritium recovery and disposal.

3.2 Tritium Safeguards and Security

Tritium is a nuclear material of strategic importance and must be safeguarded from theft or diversion. Safeguard requirements are based on the category of the nuclear material as specified in Figure I-2, "Nuclear Material Safeguards Categories," of DOE Order 5633.3B; i.e., Category I through Category IV, and the attractiveness level; i.e., Attractiveness Level A through E. Tritium is either a Category III or Category IV material depending upon the following:

- Category III – Weapons or test components containing reportable quantities of tritium. Deuterium-tritium mixtures or metal tritides that can be easily decomposed to tritium gas, containing greater than 50 grams of tritium (isotope) with a tritium isotopic fraction of 20 percent or greater.
- Category IV – All other reportable quantities, isotopic fractions, types, and forms of tritium.

3.3 Tritium Facility Safety Analysis and Regulatory Quantity Limits

A safety analysis is required by DOE Order 5480.23, "Nuclear Safety Analysis Reports," for all nuclear facilities. Irrespective of these requirements, the good practices associated with the implementation of integrated safety management principles necessitate that hazards be identified and controlled, which is a major step in the safety analysis process.

3.3.1 Safety Analysis

3.3.1.a Facility Requirements

There are a few fundamental assumptions normally made when performing safety analyses on tritium facilities, which if not satisfied will require more detailed analysis or corrective actions. These include:

- The integrity of the primary container should be ensured for all normal operations, anticipated operational occurrences, and for the design basis accidents (DBA) it is required to withstand.
- If the facility structure is not part of the secondary barrier, its failure as a result of severe natural phenomena or other postulated DBAs should not prevent the primary container or the secondary containment/confinement systems from performing their necessary safety functions.
- When secondary containers (secondaries) are used, a tritium effluent removal system to handle tritium leakage from primary containers is recommended by this Handbook but not required by regulations.

3.3.1.b Radiological Materials Inventory

Attachment 1 of DOE-STD-1027-92, "Hazard Categorization and Accident Analysis Techniques for Compliance with DOE Order 5480.23, Nuclear Safety Analysis Reports," Change Notice 1 states, "Additionally, material contained in Department of Transportation (DOT) Type B shipping containers (with or without overpack) may be excluded from summation of a facility's radioactive inventory if the Certificates of Compliance are kept current and the materials stored are authorized by the Certificate. However, Type B containers (see Section 6.1) without an overpack should have heat protection provided by the facility's fire suppression system."

Further guidance from this handbook expands this clarification to mean that if Type B containers are currently certified to withstand the credible facility accidents in which they are located, then their inventories could be excluded for SAR purposes. If the containers are not currently qualified (qualifications expire on a fixed schedule), then their contents must be included in the summation of facility inventory and be included in accident analyses, irrespective of accident conditions. If, however, the container is currently certified, then a comparison of the conditions resulting from transportation and facility accidents is performed. For example, consider a currently certified Type B container that has been qualified to withstand fire and crush loads (i.e., Type B Hypothetical Accident Crush Test loads) associated with a transportation accident. If these transportation accident conditions are more severe than the associated credible facility accident conditions (e.g., fire and seismic crush loads), then the inventory in these containers can be excluded (irrespective of fire suppression system coverage) in the safety analysis. If the facility fire conditions exceed the transportation fire conditions, the inventory is included. Note that credit for safety-grade or safety-

significant class fire suppression will affect the selection of the credible facility fire scenario and therefore the fire conditions for comparison to the transportation fire conditions.

If the transportation accident conditions are less severe than the facility accident conditions, then the contents are included in the accident scenarios. For example, if the seismic crush loads exceed the transportation crush loads, the contents cannot be excluded from the facility seismic accident scenarios. They could, however, still be excluded from the facility fire scenarios if the transportation fire conditions bound the facility fire conditions.

DOE-STD-1027-92 Change Notice 1 does not provide explicit exemption criteria for other than Type B containers. Future guidance for other than Type B containers, in addition to the guidance concerning the degree and amount of residual tritium inventory to include in safety analyses, will be included in the next revision of this handbook.

The threshold quantities of radiological material inventory [18-20] are as follows:

- Hazard Category I: (Nuclear Facility) Generally Limited to Nuclear Reactors: Regardless of the quantity of tritium in the inventory, a facility that handles only tritium is not classified, by tritium quantity alone, as a Hazard Category I. The PSO may designate a tritium facility as Category I if the potential for significant offsite consequences exists. [18]
- Hazard Category II: (Nuclear Facility): To be classified as a Category II nuclear facility, the facility tritium inventory must be > 30 grams. [18]
- Hazard Category III: (Nuclear Facility): To be classified as a Category III nuclear facility, the facility tritium inventory must be > 1.6 and < 30 grams. [18]
- Radiological Facilities: (Not Nuclear Facilities): Facilities that have less than 1.6 grams of tritium in the facility radiological material inventory are not classified as “nuclear facilities,” unless they contain higher than threshold values of other radionuclides. These facilities are classified as radiological facilities. [18]
- Non-Radiological Facilities: Facilities that have less than 100 Ci of tritium are classified by the DOE Offices of Defense Programs (DP) and Environmental Management (EM) as non-radiological facilities, unless they contain other radionuclides above reportable quantities. [19, 20]

3.3.1.c Material Release Assumptions

Once the total inventory available for release is known, the appropriate source term can be calculated. The components of the source term, as described in DOE-HDBK-3010-94, “Airborne Release Fraction/Rates and Respirable Fractions for Nonreactor Nuclear Facilities,” are material at risk, damage ratio, airborne release fraction, respirable fraction, and leakpath factor. The factors for airborne release and respirable fractions are normally assumed to be 1.0 for elemental tritium and oxide. The other factors are facility specific. For fire scenarios, the fraction of the release assumed to be oxide is normally 100 percent. Typical scenarios to review for inclusion in safety analyses are area fires (single and multiple Fire Control Areas (FCA)), full facility fire, leaks/spills, hydrogen explosions, and Natural Phenomena Hazards (NPH) events (the design basis earthquake (DBE) may have a seismic induced fire, which usually results in the bounding

accident). DOE-STD-3009-94, "Preparation Guide for U.S. DOE Nonreactor Nuclear Facility Safety Analysis Reports," provides detailed guidance for performing accident analyses.

One method of estimating dose is through the use of the HOTSPOT health physics codes developed by Steven C. Homan of LLNL. These codes operate on a PC, and provide a fast calculational tool for evaluating accidental releases. They are a first-order approximation of the radiation effects associated with short-term (less than 24 hours) atmospheric release of radioactive materials. Reference [21] is a detailed analysis by Bill Wall of LLNL for estimating maximum dose from a tritium release that uses HOTSPOT methodology as its base. Fifteen DOE tritium release locations (note that ground release locations will differ slightly from stack locations) were analyzed, the results of which should be considered as preliminary, and are presented in Table 3-2. A set of consistent conservative assumptions was used for all locations. Dose results are presented in current SARs, and are not directly intercomparable due to differing assumption sets among sites. These were calculated, in part, to help provide personnel involved in a real-time determination of bounding doses from tritium releases. These tabled values are worst-case doses for the associated curie releases at these locations, and cannot be compared to the dose values calculated in the SARs, which are normally estimated by more detailed computational methods. Additionally, the use of actual meteorological conditions and site topography would mitigate the tabled values here to smaller doses. An estimation of the impact of topography on the deposition velocity can be found in the document, "Estimates of Dry Deposition and Plume Depletion over Forests and Grassland" (IAEA-SM-181/19), Ray Hosker, Jr. In fact, in many cases, the atmospheric conditions needed for the worst-case doses from ground and stack releases presented here are mutually exclusive. Indeed, one of the objectives of reference [21] was to determine which combinations of conditions and parameters result in worst-case doses. Readers are encouraged to review and comment on the detailed analysis presented in [21].

TABLE 3-2. Worst-case doses in rem resulting from release of 1 Ci of tritium

SAVANNAH RIVER SITE						
Facility		OXIDE		ELEMENTAL		
		Ground	Stack	Ground	Stack	
233-H	Site Boundary	6.0E-7	1.8E-7	2.4E-11	7.2E-12	
	100 meters	1.6E-3	2.1E-5	6.4E-8	8.4E-10	
238-H	Site Boundary	6.0E-7	1.5E-7	2.4E-11	6.0E-12	
	100 meters	1.6E-3	9.8E-6	6.4E-8	3.9E-10	
234-H	Site Boundary	6.0E-7	3.7E-8	2.4E-11	1.5E-12	
	100 meters	1.6E-3	2.1E-7	6.4E-8	8.4E-12	
232-H-line 1&2	Site Boundary	6.0E-7	3.7E-8	2.4E-11	1.5E-12	
	100 meters	1.6E-3	2.1E-7	6.4E-8	8.4E-12	
232-H-line 3	Site Boundary	6.0E-7	3.7E-8	2.4E-11	1.5E-12	
	100 meters	1.6E-3	2.1E-7	6.4E-8	8.4E-12	
MOUND						
Facility		OXIDE		ELEMENTAL		
		Ground	Stack	Ground	Stack	
NCDPF	Site Boundary	1.6E-3	3.2E-6*	6.4E-8	1.3E-10*	
	100 meters	1.6E-3	2.3E-6	6.4E-8	9.2E-11	
HEFS	Site Boundary	1.6E-3	2.5E-6*	6.4E-8	1.0E-10*	
	100 meters	1.6E-3	1.4E-6	6.4E-8	5.6E-11	
SWIC	Site Boundary	8.0E-4	2.5E-6*	3.2E-8	1.0E-10*	
	100 meters	1.6E-3	1.4E-6	6.4E-8	5.6E-11	

DOE-HDBK-1129-99

Facility		OXIDE		ELEMENTAL	
		Ground	Stack	Ground	Stack
T West	Site Boundary**	7.0E-4	1.5E-6*	2.8E-8	6.0E-11*
	100 meters	1.6E-3	2.1E-7	6.4E-8	8.4E-12
T East	Site Boundary**	2.8E-4	1.4E-6	1.1E-8	5.6E-11
	100 meters	1.6E-3	2.1E-7	6.4E-8	8.4E-12
LOS ALAMOS NATIONAL LABORATORY					
Facility		OXIDE		ELEMENTAL	
		Ground	Stack	Ground	Stack
WETF #1/#2	Site Boundary	2.0E-5	8.5E-7*	8.0E-10	3.4E-11*
	100 meters	1.6E-3	8.7E-6	6.4E-8	3.5E-10
TSFF	Site Boundary	3.0E-5	8.5E-7*	1.2E-9	3.4E-11*
	100 meters	1.6E-3	8.7E-6	6.4E-8	3.5E-10
TSTA	Site Boundary	1.2E-4	2.3E-6	4.8E-9	9.2E-11
	100 meters	1.6E-3	6.1E-6	6.4E-8	2.4E-10
LAWRENCE LIVERMORE NATIONAL LABORATORY					
Facility		OXIDE		ELEMENTAL	
		Ground	Stack	Ground	Stack
Bldg. 331, #1/#2	Site Boundary	1.5E-4	2.8E-6	6.0E-9	1.1E-10
	100 meters	1.6E-3	6.1E-6	6.4E-8	2.4E-10
PANTEX					
Facility		OXIDE		ELEMENTAL	
		Ground	Stack	Ground	Stack
SNM Facility Building 12-116	Site Boundary	1.2E-5	NA	4.8E-10	NA
	100 meters	1.6E-3	NA	6.4E-8	NA

* This value is the worst-case dose to the public, which does not occur on site boundary but at a larger distance from the facility, as estimated in reference [22]. The individual is designated to be the maximally exposed member of the public.

** Mound Central Operations Support Building is not considered a public boundary by DOE Miamisburg interpretations. [22]

In some cases, primarily at the DOE Mound facility, the worst-case offsite dose does not occur at the site boundary, but can occur some distance away (due, in part, to high stacks and short distance to site boundaries). Additionally, the DOE Mound Office defines the personnel using the buildings onsite that have been turned over to the community (e.g., the Central Operations Support building) as collocated workers and not as members of the public [22]. If these individuals were instead reclassified as members of the public, then use of this calculational method would result in an increase in some of the tabled site boundary doses from ground releases at Mound. It should be noted that several federal environmental laws (e.g., Comprehensive Environmental Response, Compensation, and Liability Act (CERCLA), Emergency Planning and Community Right-to-Know Act (EPCRA), and the Clean Water Act (CWA) require that releases of hazardous substances above reportable quantities (for tritium, this is 100 curies in 24 hours) be reported to the National Response Center. In many cases, the curie levels are back-calculated from offsite dose receptor requirements (see Section 8.1.3). Current guidance from "Hazardous Substance Release Reporting under CERCLA, EPCRA §304, and DOE Emergency Management System/Occurrence Reporting Requirements," DOE/EH-0383, makes a distinction between "normal" or "routine" releases and "abnormal" or "accidental" releases, and suggests reporting abnormal or accidental releases, even if they are below federally permitted levels.

3.3.2 Integrated Safety Management

All tritium-related operations and activities, including design, construction, system acceptance and turnover, operations, shutdown, deactivation, and decommission for Category 2 and 3 Nuclear Facilities (and Category 1, if ever applicable), should follow commitments identified in DOE Integrated Safety Management (ISM) directives of the 450.4 series, which were an outgrowth from the Defense Nuclear Facilities Safety Board (DNFSB) 95-2 Implementation Plan. The commitments for ISM follow the seven Guiding Principles:

1. Line Management Responsibility for Safety
2. Clearly defined Roles and Responsibilities
3. Personnel Competence Commensurate with Responsibilities
4. Balance of Priorities
5. Identification of Safety Standards and Requirements
6. Hazard Controls Tailored to the Work Being Performed
7. Operations Authorization.

The process for planning and conducting pre-work hazardous analysis for all work operations at tritium facilities should be consistent with the Guiding Principles listed and should follow a structured approach commensurate with the risks and hazards involved. Several methods of enhanced work planning and related work planning strategies used throughout the DOE complex follow five steps: 1) Define Scope of Work, 2) Determine and Analyze Hazards, 3) Develop and Implement Controls, 4) Perform Work, and 5) Monitor Work Performed and Provide Feedback/Improvements. This sequence is one of many ways to ensure a structured approach in work planning with a focus on worker safety and reduced environmental risks.

3.3.3 Facility Segmentation

Facility segmentation is discussed in DOE-STD-1027-92. Activities conducted in the same facility may be separated into different areas for analysis purposes, but only if independence (in accident space) can be shown. Potential areas for segmentation include:

- Receiving area,
- Receiving storage area,
- Shipping area,
- Shipping storage area,
- Tritium unpackaging, handling, and packaging operations,
- Low-level waste accumulation area,
- Low-level waste packaging area, and
- Packaged low-level waste storage area.

The independence of the segments, however, is not easily demonstrated. Common piping and heating, ventilation, and air conditioning (HVAC) cannot exist to use this segmentation process. Additionally, common cause initiating events (e.g., fire, seismic) affect multiple segments, thereby placing an additional burden of proof on the analyst to demonstrate independence. A successful segmentation analysis, however, would not affect the applicability of Price-Anderson enforcement of the Nuclear Safety Rules to the facility.

3.4 Radiological Materials Quantity Limits

3.4.1 Tritium Shipping, Radioactive Material Inventory, Quantity Limits

Once an item has met the DOE and U.S. Department of Transportation (DOT) requirements for shipment (properly packaged, radioactively surveyed, properly marked, properly filled out shipping papers, etc.) then the item inside the approved shipping package can be shipped to a new location.

During shipment, the item inside the approved shipping package is expected to be subject to the normal activities associated with its movement from one location to another; for example, loading and unloading the package from vehicles, transport to a shipping area, storage in the shipping area prior to transport, loading and unloading the package onto trucks/trains/airplanes, and storage in the receiving area after arrival at the new destination.

The packaging required by DOT/NRC regulations is designed to protect the workers, the public, and the environment from the radioactive material during normal package handling, transport, and shipping/receiving storage.

The applicable requirements for various quantities of tritium for transportation and storage are roughly as follows:

- Limited Quantity (< 21.6 Ci for gas; see Table 7-1 for solids, liquids, and applicable 49 CFR 173 requirements): Limited Quantities of tritium can be packaged and shipped in strong, tight containers (paper boxes, paint cans) with proper markings.
- Type A Quantity (21.6 to < 1080 Ci): Type A quantities of tritium use DOT Specification 7A containers, properly marked and surveyed prior to shipment. A number of different packages are available from small cans, 55 and 85 gallon drums, 4 x 4 x 7-foot steel boxes, up to and including oversized, specially designed containers. These containers are relatively inexpensive.
- Type B Quantity (> 1080 Ci): Type B quantities of tritium must be shipped in a certified DOT Type B package. There is only a limited number of these expensive Type B packages available for tritium shipment (e.g., UC-609, TRUPACT-II), and special routing (i.e., prescribed routes employing highway route control such as using major highways, bypassing cities, etc.) is required.
- Type B Quantity, Low-Level Radioactive Waste: For the purposes of storage at the waste site, Type B quantity solid waste can be stored in Type A containers.

At the waste generation location, items containing greater than 1080 Ci quantities of tritium are normally stored in Type A containers. These Type A containers containing over 1080 Ci must then be placed into Type B containers for shipping to DOE waste sites. At the DOE waste site, the Type A containers can be removed from the Type B package and stored in the Type A package. This allows the expensive Type B package to be freed up to be returned to the shipper and reused for another Type B shipment. A radiological materials inventory must still meet the requirements as discussed in Section 3.3.1.b.

3.4.2 Tritium Receiving Area, Shipping Area, Quantity Limits

There are no limits (other than local administrative limits) on the inventory of approved containers that can be stored in a properly marked shipping area, receiving area, shipping storage area, and receiving storage area. There are, however, site-wide limits that may be imposed in the EIS that could restrict the total inventory quantities.

These areas must be inside an area posted as a "Controlled Area." The controlled area encloses an area posted as a Radioactive Materials Area (RMA). The Controlled Area and the Radioactive Materials Area can be the same area. The RMA must be periodically surveyed and appropriately marked to indicate the nuclear hazard associated with the area. These areas may have more than one incoming or outgoing certified package containing Type A or B packages waiting for transport.

3.5 Tritium Unpackaging, Handling, and Packaging Areas, Quantity Limits

The tritium is removed from the specification package/certified package in unpackaging, handling and packaging areas, and, as such, these areas should be designated as radiological areas or Hazard Category II or III nuclear facilities, depending upon the quantity of tritium in the inventory.

3.6 Tritium Waste Collection and Waste Packaging Area, Quantity Limits

The waste collection/packaging area will have, in process, the collection and packaging of low-level waste. The waste collection/packaging area should be designated as a radiological facility or nuclear facility as defined by the quantity of tritium.

3.7 Tritium Focus Group (TFG)

The TFG is comprised of both DOE federal and contractor personnel associated with tritium operations. It was formed in 1991 in response to the Secretary of Energy's Task Force on tritium operations, and has expanded in scope and stature since that time. Its charter is contained in Appendix F. The TFG maintains a Web site (www.er.doe.gov/production/er-80/tfg), which is a comprehensive vehicle containing information on current tritium issues.

4.0 FACILITY DESIGN

DOE tritium facilities, as a subset of DOE nonreactor nuclear facilities, must conform to the design requirements contained in DOE O 420.1, "Facility Safety." Implementation guidance of this Order can be found in DOE G 420.1/B-0, and in two interim-use Guides, DOE G 420.1-X and DOE G 420.1-Y.

4.1 Tritium System Philosophy

Tritium-related construction projects in the past have been designed and managed by personnel who are qualified to design standard industrial buildings and equipment but lack experience with tritium operations. During the design and construction phase, limited use had been made of tritium expertise, and, after building completion, the staff must adapt the facility for tritium operations. It is more desirable to have tritium construction projects managed by a team that includes tritium

expertise on staff. The building/systems would be designed to meet the needs of the user, and costly retrofits after completion could be avoided.

During the first 25 years of tritium technology, the handling techniques in use were designed to protect the worker from exposure to tritium. Worker protection was provided primarily by the use of single-pass ventilation systems designed to rapidly remove any tritium released in the breathing space from the area occupied by the workers. The ventilation gases were released through an elevated stack at high velocity to massively dilute the gases before they could reach ground level. Single-pass ventilation systems and high-velocity hoods were used extensively and quite successfully for worker protection during these early years. These high-velocity ventilation, high-velocity air hood, and elevated release techniques are still used for worker protection, but generally as a supplement to improved barriers that better protect the environment.

In those early years, the room or building enclosing the tritium activity was equipped with a single-pass ventilation system that did not recirculate the air back into the facility. Outside air was brought in by the ventilation fans, conditioned for comfort, passed through the building spaces one time, and was then released to the environment through an elevated stack. The room air exchange rate generally accepted to be adequate for worker protection was 6 to 10 room air changes per hour.

The tritium apparatus was enclosed in a high-velocity air hood, and the worker worked through gloves in the doors or reached in through hood openings to operate the equipment. The high-velocity air hoods were maintained at a pressure negative to the room spaces, and the natural air flow was from the room through the hood opening and then out the ventilation duct work and up the stack to the environment.

Tritium releases that occurred due to normal operations, component failure, and worker error were inside the hood. The high-velocity air flowing through the hood swept any released tritium away from the worker and out the stack to the environment where the tritium was massively diluted in concentration. These techniques protected the worker; however, tritium was released to the environment.

As concern for the environment increased, tritium technologists first attempted to control releases by increasing design and material selection requirements, adding and enforcing regulations, and increasing worker training and awareness. Time would prove that these techniques, although helpful, were not completely successful. The tritium workers were already operating at a high performance level and the tritium releases associated with equipment design and material selection were not measurably decreasing as a result of the more stringent design requirements and reviews. Tritium releases continued to occur. The expectation of faultless materials and errorless workers was unrealistic. By the late 1960s and early 1970s, it became obvious that a more realistic tritium culture was needed that better protected the worker, the public, and the environment. The new culture was one of capture, containment, and cleanup.

4.1.1 Tritium Capture, Contain, and Cleanup Process

The capture, contain, and cleanup process encloses the primary or first wall tritium container inside a secondary container such as a double-walled container, glovebox, room, or building so that any tritium escaping from the primary container is captured in the secondary container. A tritium removal system associated with the secondary container then removes the tritium from the secondary by circulating the captured gases through a cleanup system.

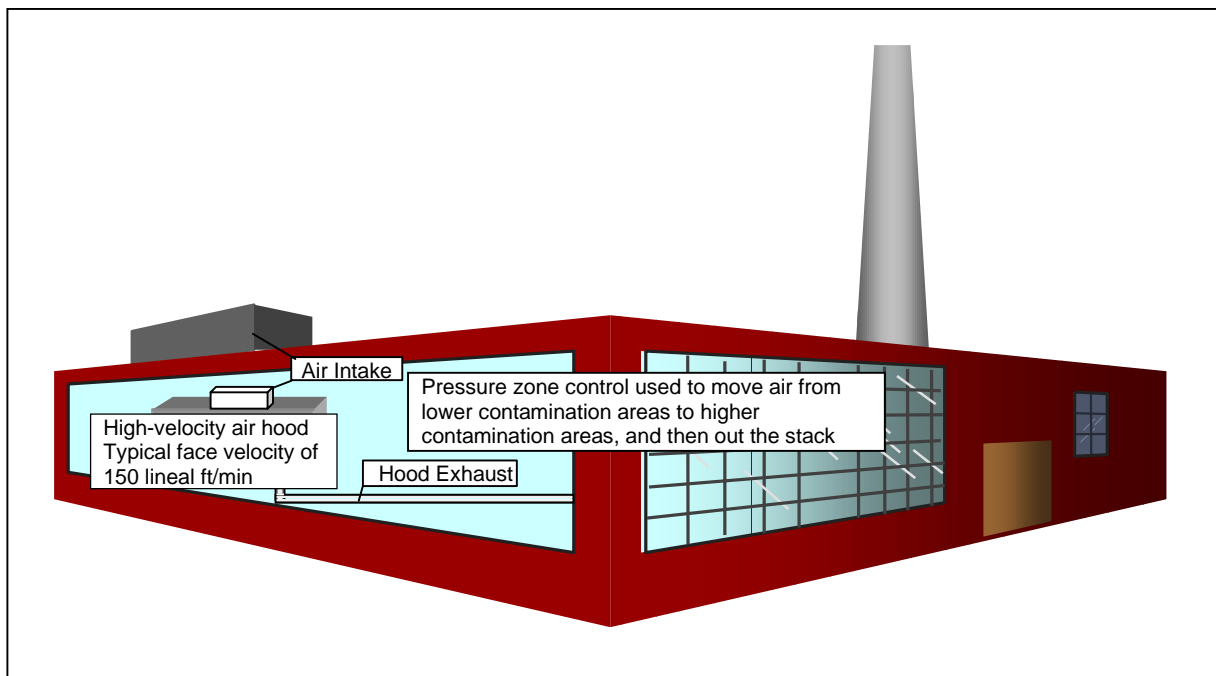

FIGURE 4-1. Tritium facility single-pass ventilation system

4.1.1.a Containment and Confinement Systems

There are many different technical descriptions of the terms containment and confinement. The simple dictionary definitions are: containment – being contained, which in turn is to hold or enclose; and confinement – being confined, which in turn is to restrict, to keep within limits. It is beneficial to define how these words are used in the tritium field. In some facilities and applications, the terms are used interchangeably. The Tritium Focus Group definitions are defined in Appendix B, Definitions. This Handbook, as noted in the Definitions, makes a distinction between these terms as follows:

Containment system – A collection of passive barriers that can satisfy a specified leak criterion without operation of any ancillary equipment. An example of a containment system is a series of piping and vessels enclosing tritium gas operations.

Confinement system – A collection of barriers that can satisfy a specified leak criterion contingent upon operation of its ancillary (active) system. An example of a confinement system is a glovebox and its associated cleanup system.

Note that in the context of these definitions, a glovebox with an associated glovebox cleanup system is a confinement system. A glovebox structure itself is a containment system if, and only if, the specified leak criterion can be met by the structure itself.

4.1.1.a(1) Primary Containers

Operations are conducted with tritium enclosed inside leak tight primary containers consisting of parts such as valves, tubing, pipe, components, transducers, pumps, and vessels. The leak rate of these primary containers, at operating pressure, is generally certified to be less than 10^{-6} to 10^{-7} cm^3 of helium per second (cm^3 He/sec). The quantity of tritium released during all normal operations is extremely small and can be estimated from the engineering specifications. Many primary tritium systems are designed with pressure relief protection. These devices should not relieve directly into the environment, but rather into holding tanks designed with sufficient capacity to retain the entire contents of the primary system.

4.1.1.a(2) Secondary Containers

In modern tritium operations, the primary container is enclosed inside a secondary barrier such as a glovebox. The secondary system is only exposed to the tritium, which is released from the primary barrier.

Secondary containers in the DOE complex vary in size, shape, leak rate, and quality depending upon the age, projected use, and the quantity of tritium at risk.

4.1.1.a(2)(a) High-Quality Secondary Containers

Some operations are equipped with high quality, double-walled pressure vessels. The outer pressure vessel is the secondary containment system, and the inner container is the primary container. This type of secondary containment system is generally used for storage of large quantities of tritium of very high quality, and is certified at operating pressure to leak rates of less than 10^{-6} to 10^{-7} cm^3 He/s.

These high-quality secondary containment systems safely store any tritium released from the primary container for several days or weeks without a significant release to the environment. The maximum quantity of tritium released from these high-quality systems during a significant primary container leak can be accurately estimated from the secondary containment system engineering specifications.

The space between the primary vessel and the secondary container in these systems is usually evacuated during service. If tritium is released into these spaces, there are no dilution gases present, and the gas leaking from the secondary container is in the same form as the gas in the primary container. If the gas released into this high-quality secondary is 90 percent tritium, less than 1 Ci of tritium will be released to the surrounding area for each four to 40 storage days.

Following a release into a high-quality secondary container, the tritium can be recovered in almost the original purity by pumping it from the secondary container into another primary container. Several days can elapse during the recovery process without a significant release of tritium to the environment.

4.1.1.a(2)(b) Medium-Quality Secondary Container

It is not practical or possible to enclose all primary tritium containers inside high-quality, non-diluting, evacuated secondary containers. Gloveboxes, as discussed in 4.1.1.a, can be utilized in both secondary containment and secondary confinement systems. Most primary containers can

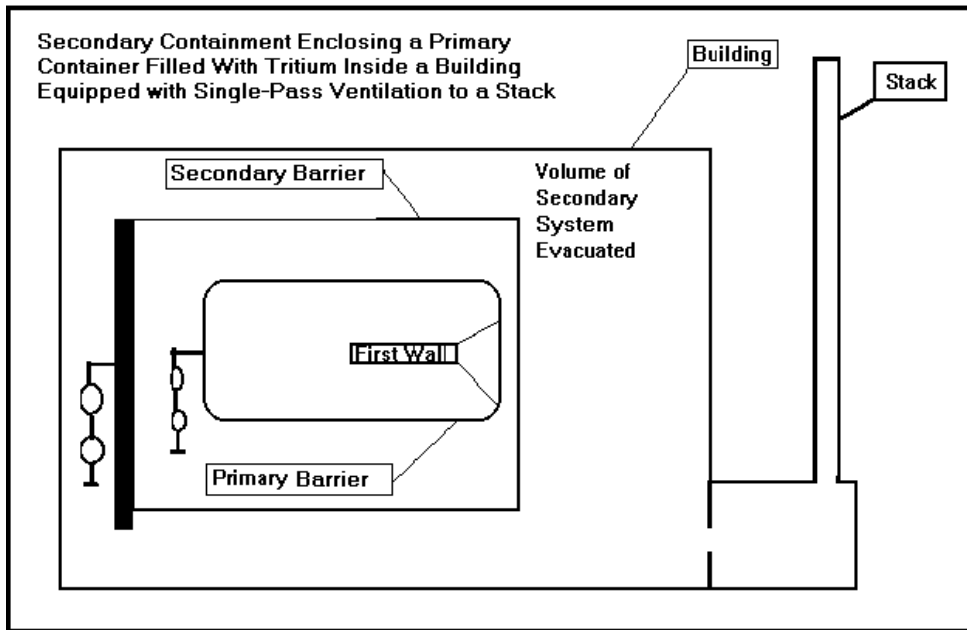

FIGURE 4-2. Secondary containment

be enclosed in gloveboxes. The box gives access to the primary containers for ease of operation and maintenance. The leak rate of a glovebox can generally be certified to be no more than 10^{-3} to 10^{-4} cm³ He/s. Tritium permeation and diffusion through the elastomeric seals and gloves is reasonably well known, and the tritium released from the glovebox during a primary container leak can be accurately estimated.

If tritium is released into the glovebox, the gases in the glovebox are mixed with and dilute the tritium. The gases leaking from the glovebox are then in the form of tritium mixed with the glovebox gases.

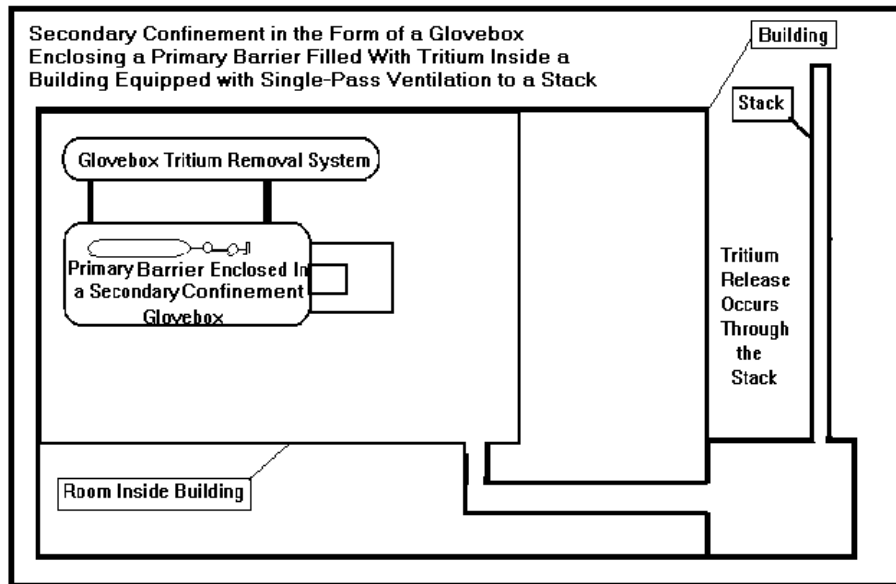

FIGURE 4-3. Secondary confinement

Assuming a glovebox with a volume of 1 m^3 and a release of 10 grams of tritium, the glovebox concentration following the release will be 0.1 Ci/cm^3 . Even at the relatively high leak rates of 10^{-3} to $10^{-4} \text{ cm}^3 \text{ He/s}$, approximately 0.1 Ci of tritium will be released for every 1,000 to 10,000 seconds of elapsed time. This is a release of approximately 1 Ci from the facility stack for every 3 to 30 storage hours, which generally does not pose a significant health risk.

Following a release into a glovebox, the tritium is recovered in a tritium removal system. This low-level waste is in the form of water contaminated with tritium. Several hours can elapse during the recovery process without a significant release of tritium to the environment.

4.1.1.a(2)(c) Low-Quality Secondary Containers

Other facilities are equipped with lower quality systems such as rooms or buildings. It is difficult to determine the leak rate of these low-quality systems and, therefore, it is difficult to estimate the quantity of tritium that will be released to the environment during a primary container leak.

If the secondary container is a room or building, the ventilation system is shut off to prevent release of the tritium through the building stack following the release. The tritium then finds its way to the environment at ground level through the building walls, ceiling, doors, and windows. The tritium released contaminates the building and the area adjacent to the building. If a tritium cleanup system is employed, (in a room or a building), the ventilation system is switched over to the recirculation mode to prevent release of tritium through the building stack. Even in this mode, tritium is released to the environment as described above, but in a lesser quantity.

For example, assuming a 100 m^3 (20 x 18 x 10 feet) building and a 1-gram release to the building, the tritium concentration in the building gases will be 0.0001 Ci/cm^3 . If the building is the containment barrier, it will leak approximately 5 percent of its volume to the environment per hour; therefore, an environmental tritium release of 500 Ci/hr will result.

A significant fraction of the tritium released from the primary containment system will be released to the environment before recovery is accomplished due to the high leak rate of these low quality secondary systems. However, these low-quality systems still have a place in the tritium containment strategy. These room- or building-type systems, equipped with high flow rate tritium removal systems, are used in facilities where there are no other feasible alternatives due to the large size of the equipment being enclosed.

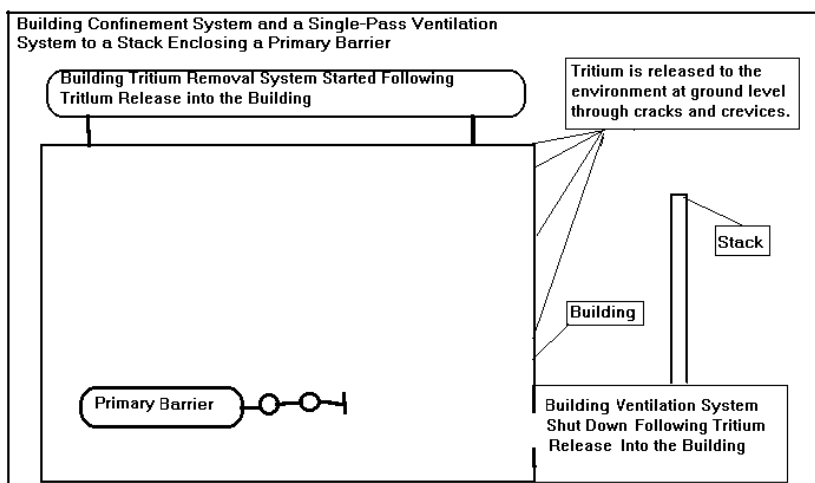

FIGURE 4-4. Building confinement system

4.1.2 Tritium Cleanup and Removal Systems

Current designs employ tritium removal systems. When tritium is released into a secondary, the associated cleanup system starts, and the gases containing tritium are circulated through the cleanup system, and the tritium is removed. See Figure 4-5 for a diagram of a typical gas-to-water conversion tritium removal system.

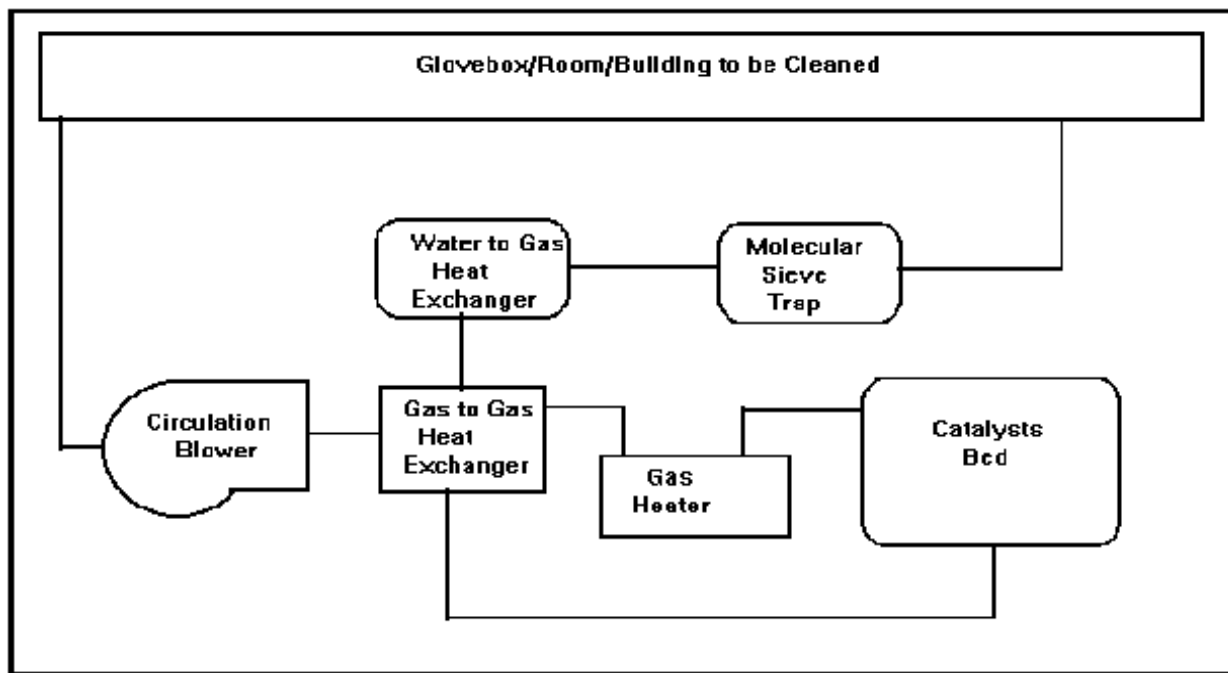

FIGURE 4-5. Typical gas-to-water tritium removal system flow schematic

If the cleanup system is associated with a high quality barrier (leak rate of less than 1 Ci of tritium in a period of 4 to 40 days) then tritium transfer to another container can take several days to complete without a significant release of tritium to the environment. If the cleanup system is associated with a medium quality barrier (leak rate of less than 1 Ci in 3 to 30 hours), then the cleanup system flow rate needs to be high enough to remove tritium within a few hours in order to prevent a significant release of tritium to the environment. If the cleanup system is associated with a low quality barrier, (leak rate of 8 Ci or more per minute), then the cleanup system flow rate needs to be very high so that tritium is removed from the gas before it is released to the environment.

The captured tritium is generally removed by circulating the gas through a system that removes tritium down to the part-per-billion level. Typical present-day cleanup systems remove tritium by cracking the molecules on a hot catalyst. The free hydrogen atoms combine in the catalytic reactor with the oxygen present to form water. The tritiated water is then removed from the gas by molecular sieve traps. Depending upon the tritium species, the concentration reduction of these systems can be from one million to one hundred million in a single pass.

The tritium released to the environment during this process is a function of the quantity of tritium released, the volume, and leak rate of the container, and the cleanup rate of the tritium removal system.

There are several considerations in determining the adequacy of the tritium removal system. First is the volume: the larger the volume, the longer it will take to remove tritium from the gases. Second is the tritium removal system flow rate. This rate affects the time required to remove tritium from the gases. The lower the flow rate, the longer it will take to remove tritium from the volume.

Third is the cleanup rate of the tritium removal system. This system is typically operated in a recirculating mode, but may also be operated in a single-pass mode. The tritium-contaminated gases are pumped through the tritium removal system, and the cleaned gases are either returned to the volume or released to the environment.

In a large complex system filled with equipment, it is difficult to know exactly how the returned or make-up gases will mix with gas in the system. The gas exit port should be spaced several feet away from the return port. It could be assumed that gas flows through in a slug, like a piston, and that only a single pass would be required to remove all of the tritium from the gases. Slug or piston displacement flow, however, is unlikely, and a more common assumption is to assume that the incoming tritium free gases exponentially dilute the gases.

Employing the standard assumption of exponential dilution (which has been experimentally verified in the DOE complex [23]), the quantity of tritium in the system Q_t is expressed by

$$Q_t = Q_i e^{-t(F/V)}$$

where Q_i = initial quantity of tritium released
 t = time after starting the tritium removal system
 V = volume of the system
 F = flow rate of the tritium removal system

A simple way of using the equation is to calculate the time it will take to reduce the system tritium concentration by a factor of 10. That is:

$$Q_t/Q_i = 1/10 = e^{-t(F/V)}$$

This implies:

$$-t(F/V) = \ln 1/10 = -2.3$$

or

$$t = 2.3 \times (F/V)$$

Therefore, assuming exponential dilution, the tritium concentration of the gas will be reduced by a factor of 10 for every 2.3 time constants determined by F/V . Similar calculations show that the concentration will be reduced by a factor of 100 and 1000 for every 4.6 and 6.9 time constants, respectively. Figure 4-6 is the plot of the relationship between the percent of tritium remaining in the volume with time.

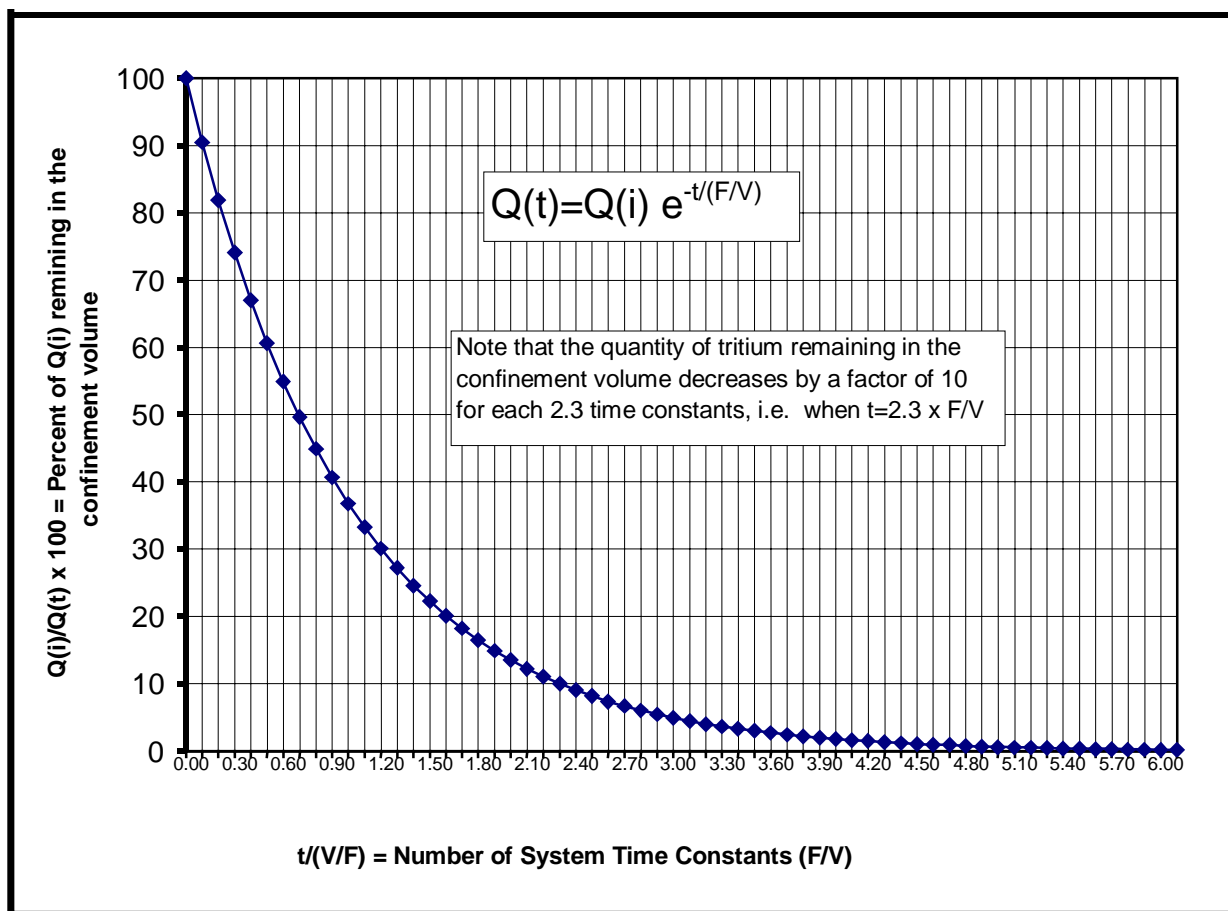

FIGURE 4-6. Confinement volume cleanup rate as a function of system time constant, F/V , assuming an exponential dilution rate

The fourth consideration is the system leak rate. While the tritium removal system is in operation, some of the gases will leak out of the system to the environment. The barrier must be leak tight enough to prevent a significant release of tritium to the environment while the tritium is being removed. A high flow rate tritium removal system can be used to help offset a leaky system, but will significantly increase the cost of the removal system.

The quantity of tritium released to the environment due to the leak rate can be calculated. Assuming exponential dilution, the concentration of tritium in the gas $C_{T2(t)}$ is

$$C_{T2(t)} = C_{T2(i)} e^{-t/(F/V)}$$

where $C_{T2(i)}$ = initial concentration of tritium in the system

t = time

V = volume of the system

F = flow rate of the tritium removal system

Note, $C_{T2(i)} = Q_{T2}/V$ where Q_{T2} is the quantity of tritium released.

Therefore, the rate of tritium released from the system, $\frac{d C_{T_2}}{d t}$, at any time, t is

$$\frac{d C_{T_2}}{d t} = L C_{T2(t)} = L C_{T2(i)} e^{-t(F/V)}$$

where L = leak rate of the system

The tritium release from the system due to leakage $T_{2(\text{rel})}$ over any time period from 0 to t, is

$$\begin{aligned} T_{2(\text{rel})} &= \int L C_{T2(i)} e^{-t(F/V)} dt \\ &= (V/F) L C_{T2(i)} e^{-t(F/V)} \Big|_0^t \\ &= (V/F) L C_{T2(i)} e^{-t(F/V)} \end{aligned}$$

The calculated leak rate that will result in a tritium release, $T_{2(\text{rel})}$, of 1 Ci due to an initial tritium release, $C_{T2(i)}$, of 1 g (10,000 Ci) into a glovebox with a volume, V, of 1m^3 and a flow rate, F, of $1\text{m}^3/\text{min}$ is

$$\begin{aligned} L &= T_{2(\text{rel})} / (V/F) C_{T2(i)} e^{-t(F/V)} \\ &= 1 / (1 \times 10000 \times 1) \\ &= .0001 \text{ m}^3/\text{min} \\ &= 1.667 \text{ cm}^3/\text{s} \end{aligned}$$

Therefore, a glovebox leak rate of $1.667 \text{ cm}^3/\text{s}$ will result in the release of 1 Ci of tritium from a 1 m^3 volume glovebox during the time it takes a tritium removal system operating at a flow rate of $1 \text{ m}^3/\text{min}$ to clean up the glovebox following a tritium release.

4.1.3 Future Directions in Tritium Removal and Cleanup

Future tritium facilities should analyze the applicability of confinement systems in their facilities. For example, DOE O 420.1, Change 2, states, "For a specific nuclear facility, the number and arrangement of confinement barriers and their required characteristics shall be determined on a case-by-case basis. Factors that shall be considered in confinement system design shall include type, quantity, form, and conditions for dispersing the material. Engineering evaluations, trade-offs, and experience shall be used to develop practical designs that achieve confinement system objectives. The adequacy of confinement systems to effectively perform the required functions shall be documented and accepted through the Safety Analysis Report."

As regulatory release criteria and ALARA concerns are strengthened, the desirability of barriers increases. Most current confinement systems are of the glovebox and of the room or building cleanup types. One disadvantage of these current designed systems is that tritium is converted to oxide, which eventually must be handled and disposed (with the attendant risks). Room or building type confinement systems are used in some tritium facilities such as in the T-building at Mound, in TFTR at Princeton Plasma Physics Laboratory, and in TSTA and WETF at Los Alamos. If the system is not very close to 100% efficient, the released oxide (which is ~ 25,000 times more toxic than the gas) could give an overall detriment (e.g., if 25,000 Ci of gas are collected, but only one Ci of oxide is released by the system, the whole operation is just a draw). Some current designs, notably the cleanup systems at RTF, make use of gettering without oxidation. Additionally, research efforts for other systems that replace the oxidation step are active in the DOE complex. The primary advantage of these getter systems is that tritium is removed and stored in elemental

form and is not converted by the tritium removal system to the more radiotoxic tritiated water. The application for glovebox atmospheres is good; however, severe challenges for removing tritium from room atmospheres with the required flow rates, while not fouling the getters, appear less promising. Research into other than metal (e.g., fullerenes) gettering material has been sponsored by EH; however, results have not been promising to date. It is possible that advances in design will make room or building-type confinement systems highly desirable, or it may turn out that these cleanup systems in general are found not to be cost-effective, and that a better use of resources to decrease environmental releases could be made by upgrading the existing primary and secondary systems. Additionally, there may be future glovebox decisions in which the oxidation process is still chosen over the gettering process due to programmatic reasons.

4.1.4 Inspection and Surveillance Requirements

Instrumentation should be provided to monitor the leak-tight integrity of process piping, tanks, and other equipment. The surveillance measurements may include those of pressure differentials or flow rates and should relate to the design leak rate. Radiation monitoring instrumentation may be used to qualitatively assess changes in leak rate.

4.2 Building Ventilation System

If tritium does penetrate its barriers, it can be released into the worker breathing space. In this scenario, the ventilation system should be designed to meet the following objectives.

- Move released tritium from the worker breathing space as soon as possible.
- Minimize the contamination of other areas while moving released tritium.
- Release the tritium-contaminated gases at an elevation and velocity that will result in massive dilution and mixing with outside air before the tritium reaches ground level.

The ventilation system should be designed using the following guidelines:

- The ventilation system should be a single-pass ventilation system. Outside air is brought in through a supply fan, conditioned for the comfort of the workers, passes through the ductwork to the ventilated spaces one time, goes through the exhaust ductwork to an exhaust fan, and is released to the environment through the facility stack.
- The air supply and exhaust systems should be designed to eliminate dead air spaces where tritium-contaminated gases may accumulate.
- The ventilation system ductwork should not be shared with non-tritium operations.
- To minimize cross-contamination from one room to another, the exhaust gas from each room should dump into a central exhaust duct. Exhaust gases from several rooms should not be combined before being dumped into the central exhaust duct.
- To minimize cross-contamination from one ventilation function to another, the gases for each type of function, such as room ventilation, high velocity air hood ventilation, and glovebox ventilation, from a single room should not be combined until they reach the central exhaust duct.

- To ensure good mixing and dilution by outside air, the exhaust gases should be released to the environment through an elevated stack at high velocity.
- The ventilation system should be designed to use pressure zone control to minimize cross-contamination. The ventilation control system is designed to hold the spaces occupied by the tritium operations at a negative pressure relative to the spaces surrounding the facility. If the whole building is a tritium facility, then the building is at a slightly negative pressure relative to the environment. If the tritium is in a single room in a building, the room is at a negative pressure relative to the adjacent rooms. Air continuously leaks into the tritium operating areas from the surrounding environment. The ventilation zones of tritium processing areas should be maintained under controlled temperature and humidity conditions at all times to reduce the in-leakage of moisture to inert atmosphere gloveboxes. (Further reductions in in-leakage of moisture into inert gloveboxes can be achieved by selecting a glove material that has a low permeation rate for moisture and by reducing the exposure time (e.g., glove port covers) and/or total glove surface area).
- The walls separating adjacent rooms must be reasonably sealed to minimize tritium released from contaminating an adjacent room. Administrative controls need to be in place to require caulking and sealing around wall penetrations such as conduit and piping.
- For the ventilation system to work as designed, the inside and outside doors and airlocks need to be used properly. Propping an outside or inside door open will upset the pressure zone control system. An outside door bypasses the stack and provides a path for a ground level tritium release. The doors should be equipped with automatic door closures, and all personnel should be instructed on the proper use of doors.
- For facilities handling gram quantities of tritium, a rule of thumb is 6 to 10 air changes per hour as the standard of performance. Depending upon the operating conditions associated with the ventilated area, ventilation rates of 3 to 20 air changes per hour have been used.

The ventilation rate should be based on analysis of the hazards of the operations. A facility that has the potential to release only a few curies of gaseous tritium into the breathing space does not need to operate at the same ventilation rate as a facility that has the potential to release tritium into the breathing space.

- Single-pass ventilation systems are expensive to operate because all air must be conditioned to make its single pass through the facility, and this conditioned air is not reused. Additionally, a high flow rate is desired in order to remove any released tritium from the facility as soon as possible to protect the workers.
- Special precautions such as Personnel Protective Equipment, including respiratory protection and passing exhaust through particulate filters, are needed when working with SMTs. D&D work with SMTs should occur within a confined airspace, if possible.

It is feasible to design future ventilation systems to operate at a variable flow rate that is a function of the time of day and the measured tritium concentration in the rooms. This would entail a higher initial cost, but would decrease the long-term operating costs without significant impact on the facility safety.

4.3 Chilled Water System

The chilled water system that is used to cool the tritium-related activities in a facility must be carefully designed to minimize the volume and tritium concentration of the contaminated water generated. The use of single-wall, water-to-gas heat exchangers in tritium removal systems and vacuum furnaces for example, will result in tritium contamination of the chilled water system. In some facilities, the same chilled water system is used to cool non-tritium activities in the same building, and, at some sites, the same chilled water system is also used in non-tritium related activities in adjacent buildings. As a result, tritium-contaminated wastewater is generated, and tritium contamination is spread from one piece of equipment to another, from one room to another, and from one building to another through the chilled water supply.

The chilled water system should be designed to minimize the volume of water that can be contaminated with tritium. One technique is to use water-to-water heat exchangers or double-walled, gas-flushed water-to-gas heat exchangers to isolate the high volume central system from the tritium-related activities. The volume of water in the secondary loop is much smaller than that in the primary loop.

The primary reason for using chilled water for cooling equipment is cost. The systems are reliable, low in cost, small in size, readily available in many different sizes from many different manufacturers, and easy to maintain. Air-to-air heat exchangers can, in some cases, be substituted for chilled water cooling, but are larger in size and will not work in some applications. Refrigerated cooling systems are more expensive, but operationally eliminate the need for disposing of tritium-contaminated water generated by the chilled water systems.

4.4 Seismic and Wind Design and Evaluation of Structures and Facilities

Savannah River Site (SRS) has been the lead site for interfaces with the DNFSB and DOE EH concerning NPH design issues associated with tritium. A summary of DOE Natural Phenomena Hazards Policy is included in Section 5.7.1. This policy is also applicable to structures and the complete facility. Section 5.7.2 and its references should be reviewed as part of the overall seismic and wind design for evaluation of a tritium facility.

For wind loading provisions, American Society of Civil Engineers (ASCE) 7-95, "Minimum Design Loads for Buildings and Other Structures," has recently been completed and issued and is changed greatly from past versions. A "3-second peak wind gust" is used rather than "fastest mile wind speed" as a design measure. Change Notice of DOE-STD-1020, "Natural Phenomena Hazards Design and Evaluation Criteria for Department of Energy Facilities," is in error in referencing ASCE 7-95, but keeping "fastest mile wind speed" as a measure. Wind speeds must be converted to "3-second peak wind gust" for ASCE 7-95 to be correctly used.

An understanding of the types of loading produced by earthquakes and windstorms is useful in planning mitigating approaches. An earthquake produces shaking, which will affect the entire facility and its contents. Attention to anchorage and connection details to all structures, systems, and components is essential. Earthquakes may also cause ground rupture if the facility is near a fault. Loss of ground stability may also occur due to settlement or liquefaction and will depend on soil types and location of the ground water table.

Windstorms generally affect the structural shell and systems and components outside of the structure. Windstorms will produce direct pressure and suction on walls and roofs with increased

loading at corners, eaves, and ridges. Extreme windstorms can produce missiles from debris near the facility or from nearby facilities. These missiles can strike walls and roofs and their effects should be evaluated. During tornadoes, in addition to pressure effects and windborne missiles, there will be an atmospheric pressure change or a pressure drop below ambient pressure as the tornado passes over a facility. This can affect wall and roof openings and ventilation system filters.

An approach used at SRS is to store resources in a Highly Invulnerable Encased Safe (HIVES). HIVES are metal cabinets designed to store tritium reservoirs and Hydride Storage Vessels (HSV). The HIVES are designed to be capable of protecting the pressure boundary integrity of stored reservoirs or HSV against impact of structural elements free falling from the collapse of Building 234-H and the adjacent 296-H stack caused by credible NPH Design Bases Accidents. The HIVES are constructed of hardened T-1 steel, primarily from 1-inch plate. The overall dimensions are approximately 22"Wx39"Dx68"H, which includes both a cabinet and a matching bonnet assembly bolted to the cabinet top plate. This bonnet contains an aluminum hexcall honeycomb material designed to absorb the impact loading stated above.

The following should be considered when designing or evaluating structures or facilities for earthquakes and windstorms:

- The Performance Category (PC) of the structure or facility should be determined. It is not necessary for the entire facility to have the same PC; that is, different parts of a facility could be in different performance categories. For example the office portion of a Tritium Handling Facility may be PC1 while the laboratory portion may be PC3.
- Judgment should be exercised to ensure that various parts of the facility have been categorized in a rational manner. For example, a PC1 facility does not physically support a PC3 facility.
- In addition to the vertical load carrying system, a lateral force resisting system should carry the seismic and wind loads. This may be a frame or shear wall system or separate bracing system. Attention to connection details is very important in ensuring adequate structural integrity to resist the limited energy input motion produced by earthquakes and the longer duration wind loading.
- An understanding of the type of loading that earthquakes and extreme winds produce on the overall structure is essential during the design and evaluation process.
- An adequate load path must be ensured throughout the structure
 - Roof and wall connection details to structural system
 - Overall roof-to-wall connections
 - Wall-to-foundation connections
 - Foundation adequacy
- Innovative technologies, such as base isolation and passive energy dissipation devices, should be considered during design of new facilities and for upgrading of existing facilities to reduce seismic loads to systems and equipment within the structure. These approaches have been used in many projects throughout the world during the last 10 years.
- Avoid the type of details and structural features that have performed poorly during past earthquakes. These are as follows:

Structural Systems

- Unreinforced masonry construction
- Non-ductile concrete construction
- “Soft” story construction
- Incomplete lateral force resisting systems
- Welded steel connections
- Irregularities, eccentricities, and discontinuities in both weight and geometry
- Pounding or impact with nearby facilities

Details

- Inadequate hoop reinforcement in concrete columns
- Reinforcing steel connections
- Connection details
- Accommodation of differential motion

- Ensure foundation adequacy by avoiding the following:
 - Ground failures
 - Landslides
 - Liquefaction
 - Excessive or differential settlement
- Ensure that lifelines are not damaged.
 - Provide flexibility in lifeline connections to the facility.
 - Identify important lifeline functions such as power, water, sewer, gas, and communications that will be needed immediately after an earthquake or windstorm.
 - Examine the vulnerability of lifelines onsite as well as offsite.
 - Plan for alternative lifeline support.
- Examine and prepare for the possibility of a fire following the earthquake.

Employing mitigation efforts before earthquakes or windstorms occur is a very cost-effective means to provide life safety, to minimize damage and losses, and to reduce the impact on the facility and operations. It is extremely important to pay attention to all details because natural phenomena will find the weak links and cause damage.

4.5 Other Design Considerations

The following items should be considered in the design of a facility with tritium operations.

- Designated safety-class systems should employ the concepts of redundancy, separation, and diversity. Some designs in the past, notably at Building 233-H at SRS (i.e., RTF), employed redundant signals to a single actuation device. An improvement to this design concept would be to provide these redundant signals to two independent, separate (by distance) actuation devices.
- A design requirement should be included to prevent the formation of explosive mixtures during the handling, processing, and storage of tritium gas and other hydrogen isotopes.

- Calibrated tanks and associated piping that are used for pressure-volume-temperature measurements should have surface treatment of their interiors (e.g., electropolished and passivated) to allow accurate volume measurements.
- Tritium process and handling systems should use, wherever possible, nonflammable hydraulic, lubricating, and cooling fluids.
- The designer should consider not using hydrogenous fluids where they might become contaminated with tritium.
- The designer should consider providing for the retention of firewater with subsequent monitoring prior to disposal for all buildings where there is tritium.
- Barriers should be provided to prevent damage to equipment and injury to personnel while performing testing operations that could produce missiles or blast pressures. These barriers should be designed using conservative and proven design principles, such as those of DOE/TIC 11268, "A Manual for the Prediction of Blast and Fragment Loading of Structures."
- An independent air system should be provided for breathing air. It should have dedicated, oil-free compressors or pressurized cylinders of breathing air, and provide breathing air in all areas of the tritium facility where it may be needed for maintenance operations and/or personnel safety. Contamination of the air supply (e.g., from refrigerant leaks or air intakes) should be detectable at levels low enough so as not to pose health concerns.
- The design considerations of the Fire Protection System should include the following:
 - determining safety classification of SSCs of both fire detection and fire suppression systems
 - consideration of unique fire sources (e.g., uranium beds used for tritium storage)
 - compatibility of fire extinguishing agents with the fire sources in a tritium facility
 - containing and handling requirements for expended fire fighting agents (including water inventory) that may become contaminated with tritium

4.6 Lessons Learned

Buildings 232-H, 233-H, and 234-H at SRS, the Weapons Engineering Tritium Facility (WETF) located at Los Alamos National Laboratory (LANL) and the Tritium Research Laboratory (TRL) at Sandia National Laboratory, Livermore (SNLL) are examples of facilities that were initially designed to perform tritium handling. Most other facilities in use were originally designed to do other work and have been retrofitted to perform tritium handling.

One of the major problems with the facility retrofit process is that the existing utilities such as ventilation, floor drains, gas supplies, and chilled water systems are shared with the adjacent non-tritium areas. The same duct work, which is used to sweep released tritium from tritium operating areas, is used to provide ventilation for offices and non-tritium areas, and, as a result, tritium back diffuses into the non-tritium areas through the shared duct work. The same chilled water system used to cool the tritium-related equipment is used to cool the non-tritiated office spaces, and leaks of tritium-contaminated chilled water result in contamination of clean areas. The floor drains from the non-contaminated areas drain into the same system as the floor drains from the tritiated areas, and, through the drains, gases flow from one area to another.

Tritium facility utilities such as chilled water, compressed air, gas supplies, ventilation, floor drains, sink drains, storm drains, and stacks should not be shared with other non-tritium areas. Sharing these systems spreads tritium contamination to other areas, complicates day-to-day management of the facility, and impacts the transition process if the facility is transitioned to other use. The use of hazardous materials should be reduced or eliminated in the initial design stages of the facility, as it will likely lead to the generation of mixed wastes and increased D&D costs.

4.6.1 SNLL Tritium Research Laboratory

Tritium operations have been terminated at the TRL, and the facility has been transitioned to other use. The problems encountered during transition of the TRL should serve as an example for facility designers of the future. The TRL was designed beginning in 1972 specifically to handle tritium, and a few changes to the initial design would have resulted in significant cost and timesaving during the transition process.

- The tritium removal system in the central glovebox had a supply and return manifold fabricated of six-inch diameter stainless steel pipe. The associated vacuum pump effluent manifold consisted of an all welded two-inch diameter pipe. These manifolds were approximately 200 feet long and extended down the central corridor of the building. The manifolds extended into each room from the corridor and were of all welded construction. During the transition process, special tooling had to be purchased to cut the six-inch and two-inch diameter pipe into sections small enough to be disposed of as solid waste.

Designing the system to include flanges and isolation valves at specific locations would have resulted in some cost savings during facility dismantlement and transition. However, since too many valves and flanges can increase the potential for leaks during operation, the installation points should be placed only at strategic locations.

- The floor covering installed in the TRL consisted of 12-inch tiles glued to the concrete floor. Both the floor tile and the adhesive contained asbestos that had to be removed during transition of the facility. Additionally, tritium-contaminated liquids were spilled on the floor during operation and leaked through the tile into the concrete below. The use of adhesives made of non-hazardous materials would have resulted in significant cost saving.

Princeton University Plasma Physics Laboratory has suggested that sealing the concrete with a thick, hard finish epoxy paint prior to installation of any floor covering would mitigate the impact of tritiated liquid spills, although even epoxy will experience tritium permeation.

- The TRL was equipped with a recirculating chilled water system. The water-to-gas heat exchangers used the chilled water to cool the glovebox and vacuum effluent tritium removal system gases, vacuum furnace heat exchangers, glovebox temperature control systems, and in a variety of other tritium-related tasks. After a few months of operation, tritium contamination was found in the chilled water. In order to control the buildup of tritium in this system, the contaminated water was periodically drained from the system and replaced with uncontaminated water.

If the initial design had used water-to-water heat exchangers as barriers, the volume of contaminated water would have been minimized. If double-walled, gas-flushed, water-to-gas heat exchangers had been used, the contamination would have been significantly lower.

- The TRL used approximately 100 oil-type vacuum pumps. Oil-free vacuum pumps were not as common when the TRL was designed. The vacuum pump oil becomes contaminated with tritium during use. At some DOE locations, tritium-contaminated oil is regulated as a mixed waste. Handling the tritium-contaminated oil is a significant safety hazard to operating personnel and should be eliminated where practical.

If oil-free vacuum pumps had been used, the generation of mixed waste in the form of tritium-contaminated vacuum pump oil would have been eliminated as would the hazard associated with changing vacuum pump oil.

- The TRL was equipped with a ten-air-change-per-hour, single-pass, pressure-zone-controlled ventilation system. Some of the ductwork became contaminated and was removed and disposed of as solid low-level (radioactive) waste during the transition process.

Experience from Sandia has suggested that if the ventilation ductwork for room air ventilation had been separated from the ductwork used for high velocity air hood and glovebox ventilation, the contamination would have been easier to control during the transition process.

- The presence of hazardous materials in the form of asbestos and oil complicated the transition process. The materials used in fabrication and during facility operation should be reviewed, and, if possible, all hazardous materials should be eliminated.
- The initial design of the TRL included collection of wastewater from floor drains and sinks in two underground holding tanks so that the water could be checked for contamination before it was sent for disposal. The holding tanks were buried and could not be inspected. The wastewater drain system consisted of several hundred feet of buried drainpipe, which drained into the holding tanks. After a few years of operation, the underground tanks were replaced with holding tanks enclosed in a below-ground-level open concrete pit. If the tanks leaked, the concrete pit would contain the leak. This design also provided for inspection of the tanks for leaks. The buried, underground drain lines remained in place throughout the life of the facility.

Wastewater holding tanks and collection systems should be designed so that potential leaks can be contained and the holding tanks and drain system can be inspected periodically.

4.6.2 SRS Old Tritium Extraction Facility

Between 1995 and 1997, a team of specialists decontaminated and decommissioned (D&D) the Old Tritium Extraction Facility (232-F) at the SRS. [24] The work was conducted in six phases. Each phase presented challenges regarding the behavior of tritium, particularly tritium in equipment and structures of metal and concrete. A description of each phase is as follows:

- Phase I, pre-Characterization/Isolation, was designed to identify the specific buildings, ancillary equipment, structures and premises to be cleaned, and isolate them in a way that avoided inadvertent contamination elsewhere in the complex.
- Phase II, Detailed Facility Characterization, included determination of the type and amount of actual contaminants and determined the location and type of disposal operations required. This phase was the most complex in terms of characterizing tritium contamination.

- Phase III, Decontamination and Dismantlement, involved removing hazardous materials such as PCBs, mercury, and lead, as well as radioactive constituents such as tritium and fission products. It also involved dismantling equipment and some structures.
- Phase IV, Demolition with Explosives, involved the removal and destruction of the facility and stack.
- Phase V, Waste Management, was a continuing process throughout all six phases. It involved the determination of how much of each contaminant was present at the site and where the various site contaminants would be disposed.

Phase VI, Green Grass Restoration, restored the site to a usable, visually aesthetic entity.

Detailed characterization was one of the most challenging phases in dealing with tritium, and required an expert understanding of the behavior of tritium in porous and non-porous materials. For example, because tritium migrates to the subsurface of porous materials, volumetric characterization required core boring. This was not well understood initially and early characterization activities, which involved smear and scabbling techniques or wiping and scraping the surface of concrete, gave false (low) tritium contamination levels. In some instances, areas that were smeared clean, began to reveal elevated readings following rain inleakage. In addition, destructive testing for nonporous material, such as metals, was required to fully characterize volumetric tritium contamination.

DOE-STD-1120-98, "Integration of Environment, Safety, and Health into Facility Disposition Activities," provides guidance for integrating and enhancing worker, public and environmental protection during facility disposition activities.

5.0 DESIGN OF EQUIPMENT

The design requirements for tritium are a function of the tritium form, quantity, concentration, pressure, and period of storage. High concentrations of tritium gas stored at high pressure (> 2,000 psia) are difficult to contain due to tritium and helium embrittlement of the container materials. Design of these systems requires careful selection of the materials of construction and must be designed using expertise in high-pressure tritium containment.

Low concentrations of tritium in gaseous form mixed with other gases at low (< 600 psia) to medium (600 to 2,000 psia) pressure, regardless of the quantity, do not significantly impact the strength of the materials they are stored in. As a result, standard designs can be used.

Tritiated water in the form of T_2O is somewhat corrosive unless properly stored with an overpressure of T_2 gas. This is due to the suppression of the formation of oxygen in the cover gas and peroxides in solution. [25] Tritium systems should be designed by persons with tritium experience.

Low concentrations of HTO (mCi/mL to Ci/mL) recovered from tritium removal systems have proven to be corrosive when stored in liquid form in metallic containers and have resulted in the development of significant leaks in containers within days or weeks. Storage of this same water

solidified on clay or on molecular sieve material, regardless of the quantity, is stable and non-corrosive and may be stored for many years in the container.

5.1 Material Compatibility

Proper materials selection and rigorous design have led to tritium-handling systems that are extremely safe for long periods of time. Materials exposed to tritium under certain conditions can be susceptible to hydrogen embrittlement. The chances of embrittlement are significantly reduced by proper material selection. No additional thickness of components, such as the “corrosion allowance” used to mitigate uniform corrosion, is added to components to reduce or eliminate the chance of hydrogen-induced cracking and subsequent failure as material degradation effects are not uniform. In the past, tritium systems were located in hood systems having a single-pass air flow to protect workers should a component fail and tritium be released; the released tritium would be removed from the facility into the atmosphere by the hood exhaust system. Current system design normally consists of a closed glovebox, with a stripper or getter system to trap the released tritium. This arrangement protects workers and prevents releases to the environment.

Tritium can permeate vessel barriers, especially in components operating at elevated temperature. Currently available tritium permeation data is normally sufficient to estimate the order of magnitude of tritium permeation through barriers. These estimates can be used during system design or to determine whether additional purging and stripping systems are required to “clean up” permeated tritium or whether other design changes (such as wall thickness, material, or coating) are required to reduce permeation. Tritium permeation can lead not only to contamination outside the barrier, but it can also result in significant quantities of tritium being dissolved in parts, which can lead to hydrogen embrittlement. Over time, this tritium decays to ^3He , which has been found to accentuate hydrogen embrittlement and to cause weld cracking (see below).

5.1.1 System Design

Tritium primary containers must have an exceptionally low leak rate (10^{-6} to 10^{-7} cm^3 $^4\text{He}/\text{second}$) and probability of failure or leaking. The consequences of tritium leaks can include personnel uptake, release to the environment, ignition (if mixed with oxygen), and violation of operating permits. Pressure and vacuum vessels used in tritium systems are generally designed and constructed using codes and standards applicable to boiler and pressure vessels. In the United States, use of the American Society of Mechanical Engineers (ASME) Boiler and Pressure Vessel Code is recommended but not required. Pressure and vacuum vessels constructed using this code have an accepted rigor in design, construction, and inspection that facilitates approval and acceptance by regulators. The ASME Boiler and Pressure Vessel Code primarily covers the design of vessels, and does not cover all of the aspects of a tritium system design. Other design standards, such as resistance to seismic events, also must be followed, depending on the location and regulators of the facility. See Sections 4.4 and 5.7 for more discussion of seismic design.

5.1.1.a Leak Testing

After fabrication, thoroughly leak testing tritium systems is extremely important. Normally, leak testing employs commercial helium-mass-spectrometer-based systems and is performed after any other required proof, pressure, or vacuum performance tests. Other leak detection methods, such as rate-of-rise, can also be employed in addition to helium mass spectrometry. A dilute solution of tritium in an inert gas can also be used to detect small leaks. Tritium is a highly effective leak

detection species, since it travels rapidly through cracks and can be easily detected at very low levels.

5.1.1.b Joining

Components of tritium systems are commonly joined by welding. Welds are normally designed so they can be non-destructively inspected by a suitable method such as radiography or ultrasonic testing. Also, the weld design should minimize so-called “virtual leaks” on the interior of tritium containing volumes. Examples of weld practices to minimize virtual leaks include 1) using full penetration welds where possible, and 2) welding feed-throughs to the interior wall surface (not on the outside, which would leave a gap on the inside around the feed-through that is difficult to outgas). Standard weld rod filler materials are chosen, depending on the base alloy. Every effort should be made to reduce or eliminate welding residual stresses.

There is less experience using other joining methods such as brazing or high temperature soldering in tritium systems. Dissimilar materials may have to be joined by a transition junction, using an intermediate material to enable proper welding and accommodate differences in thermal expansion and other properties.

Tritium gas permeates austenitic stainless steels, and, over time, ^3He is created by beta decay of tritium in solution in the material. Welding stainless steel containing solute helium is difficult because intergranular cracking can occur. During welding, the solute helium agglomerates at grain boundaries and forms both intergranular cracks in the heat-affected zone and pores in the fusion zone. Low-heat-input weld techniques have been shown to mitigate this problem to some degree; however, weld repair of helium-containing stainless steel is normally difficult to perform without some cracking.

All-metal mechanical joints are also a sound way to join components in tritium systems. Typically, copper, silver-plated nickel, or silver-plated stainless steel have been used as gaskets. Commercial high- and ultrahigh- vacuum fittings are normally compatible with tritium.

5.1.1.c Surface Coatings and Treatments

Aluminum and aluminide coatings have been successfully employed on stainless steel to reduce permeation into and through the steel. These coatings can be applied on large items using a proprietary fluidized bed furnace, having a controlled atmosphere (in the so-called “calorization” process). Gold has also been used as a permeation barrier in some applications and is often applied over a thin nickel buffer layer (“strike”) that has been applied to the bulk metal (e.g., stainless steel) after proper surface preparation.

Several companies treat stainless steel surfaces using various proprietary electrochemical processes to “passivate” the surface. These processes probably enrich the chrome content of the surface oxide, polish the surface (thereby reducing the effective surface area), and remove carbon and hydrogen from near the surface. All of these microstructural changes may be desirable for tritium systems in which the process gas must remain at high purity. Capillary lines that route gas to mass spectrometers are commonly passivated, to reduce changes of gas composition by isotope exchange, while the gas flows from the sample location to the mass spectrometer. Passivated surfaces reduce the rate of isotope exchange in hydrogen isotope mixtures, probably by reducing the catalytic effect of the surface decomposing hydrogen isotope molecules to atoms, which enables isotope exchange. Vacuum systems having surfaces treated in this way evacuate

faster. This type of surface passivation can be expensive, so many parts of tritium systems are not passivated; normally only parts requiring the special properties of passivated surfaces are treated.

5.1.2 Structural Metals

Exposure of metals to high pressure (> 2,000 psia) hydrogen, deuterium, or tritium will result in hydrogen embrittlement of the material. This could eventually result in material failure. The time until failure is a function of the container material, the pressure, and temperature. Additionally, materials exposed to high-pressure tritium are also subject to helium embrittlement. Tritium at high pressure enters the metal and decays to ^3He . The buildup of helium in the metal results in helium embrittlement, which, depending upon the pressure, temperature, and type of material, will eventually result in failure of the material. Exposure of metals to low to medium pressure tritium at normal temperatures does not generally result in material failure within any reasonable period of time.

Some metals are more resistant to embrittlement than others and, therefore, are more compatible with tritium. Depending upon the specific application, 304L and 316L stainless steel are generally considered to be the most hydrogen compatible and readily available stainless steels for tritium service. High-pressure vessels, valves, and tubing designed of these materials when used at their rated pressure and temperature will provide many years of service without material failure. When equipment is designed for tritium operations, a materials expert should be consulted to ensure that the materials selected are compatible with their intended service.

5.1.2.a Austenitic Stainless Steels

The recommended materials of construction for tritium-handling systems are from the class of wrought 3XX series of austenitic (face-centered-cubic) stainless steels, including Types 304L, 316L, and 347. Types 304L and 316L are most often used in tritium processing systems. These steels provide good strength, weldability and resistance to hydrogen embrittlement. Components fabricated from these materials are procured routinely. Many commercially available vacuum system components that are used in tritium systems, such as valves, piping, pumps, and analytical instrument sensors, are fabricated from these types of austenitic stainless steel. Wrought materials are preferred to cast because wrought materials normally have a more homogenous microstructure. In the past, tritium has leaked through parts having poorly oriented stringers and inclusions. The forging direction of some wrought components has been specified so that the orientation of inclusions is not in a direction that could result in a tritium leak path. Low carbon grades (such as 304L and 316L) are preferred to avoid weld sensitization and to reduce the number of inclusions (impurity particles such as oxides and carbides). Modern vacuum-arc-remelted steels are a good choice because they have lower impurity levels, thereby resulting in fewer inclusions that could aid hydrogen-induced cracking or provide leak paths. Typically, tritium system components employ seamless pipe and tube where practical.

Stabilized grades, such as Type 347, have been employed in applications where post-weld heat treatment is not possible. This usually occurs when a process vessel contains a working material (such as hydride or getter) that will degrade when exposed to the post-weld heat treatment, which is typically performed at about 1,100°C for austenitic stainless steels.

High carbon grades, such as Type 347H or Type 316H (having 0.04 percent carbon minimum), have been successfully employed for tritium service if high temperature strength is required. Type 347H is employed in the Hydride Transport Vessel (see section 6.2.2), and Type 316H was

employed for the SRS Building 232-H Extraction Furnace retorts. Type 310 stainless steel has good oxidation resistance and can be considered for elevated temperature applications if oxidation is a concern. Type 316 stainless has superior creep resistance but inferior oxidation resistance to Type 310.

Some types of higher-strength austenitic stainless steels not generally employed for tritium service may be required for fasteners (such as nuts and bolts) in mechanical joints in high-temperature regions. This may be acceptable if the bolts are exposed to only residual amounts of tritium. These materials also may be used to contact 3XX stainless steels to avoid galling of mating screw contact surfaces. Typical materials used in these applications include Nitronic 60, Nitronic 50 (also called 21-13-9) and Nitronic 40 (also called 21-6-9); these are all nitrogen-strengthened austenitic stainless steels.

5.1.2.b Copper and Copper Alloys

In principle, copper should be a suitable material in tritium systems. Copper has several tritium-compatible properties. Tritium has a low permeability in copper, and copper is a ductile, stable, face-centered-cubic metal and so is resistant to hydrogen embrittlement. The high thermal conductivity of copper is a desirable property for process vessels requiring heat flow or constant temperature. Copper can be easily joined in a number of ways (e.g. soldering, brazing, welding). In spite of these advantageous properties, copper and copper alloys are not commonly used in tritium systems. Several factors may account for this. The ASME allowable design strength of copper falls rapidly at temperatures above 200 °C, making it difficult to use copper for process beds that operate at elevated temperature. Also, hydrogen isotopes can react at elevated temperature with oxygen in copper, whether the oxygen is in solid solution or in copper oxide precipitates. In either case, water is formed, and over time water vapor agglomerates at grain boundaries, which eventually results in intergranular cavitation, cracking, and failure. This failure mechanism is sometimes termed “steam embrittlement.” Also, a transition junction (normally nickel) is required to join copper and the stainless steel components of the remainder of the system.

5.1.2.c Aluminum and Aluminum Alloys

Aluminum has properties making it potentially desirable for tritium systems. It has a low density and a high thermal conductivity. Hydrogen isotope permeability is very low in aluminum compared to stainless steel. Aluminum is used in applications where light weight is important, such as in containers that must be lifted by personnel in gloveboxes. However, aluminum is not commonly used in tritium systems. Stainless steel has much higher strength, at room and elevated temperature. Welding aluminum requires more precautions because aluminum reacts with atmospheric water vapor, which can cause porosity due to hydrogen in the weld fusion zone.

5.1.2.d Materials to Avoid

Plain carbon steels and alloy steels must not be used for tritium service. These steels have high strength and (normally) a body-centered-cubic crystal structure, both of which make the material less ductile and much more susceptible to hydrogen embrittlement. Ferritic stainless steels (such as Type 430), martensitic stainless steels (both quench-and-tempered (such as Type 410) and precipitation hardening (such as 17-4 PH and PH 13-8 MO)) and precipitation hardened austenitic stainless steels (such as AM-350) should not be used for general tritium service; they are all more

susceptible to hydrogen embrittlement than the austenitic stainless steels. Additionally, free-machining grades of austenitic stainless steel (such as Type 303) should not be used.

Other materials that must not be used for tritium service are any material that forms hydride near room temperature and atmospheric pressure. Examples include zirconium, tantalum, niobium, and many alloys of these materials.

5.1.3 Polymers

All polymers degrade when exposed to radiation. Both tritium and tritiated water permeate all polymers, and permeated tritium deposits the beta decay energy throughout the polymer bulk. (Although the tritium beta energy is very low and has a small penetration depth in matter, permeation allows tritium atoms to be near enough to polymer chains throughout the bulk to cause changes in the polymer by radiation.) Types of radiation-induced changes in polymer properties include either softening (degradation) or hardening, ductility loss, color change, dimensional change, and gas evolution. Because of these effects, polymers should only be used in tritium systems where no metal alternatives exist. Normally, only polymers that harden during radiation exposure are employed, and are replaced before they begin to deteriorate. In addition to polymer breakdown itself, products of degradation can form corrosive liquids or acids such as HF and HCl. Polymer parts must be easily replaceable as a part of normal operations, and a program of regular inspection and replacement should be established. The system should be designed to expose any polymers to as little tritium as possible. Typical uses of polymers in gas-handling systems include gaskets, O-rings, electrical cable insulation and valve parts, including seats, stem tips, and packing.

Polymers relatively resistant to radiation can typically withstand up to about 1 million rad (1 rad = 100 erg energy deposited per gram of material). By knowing the solubility of tritium in a polymer at a given temperature and tritium partial pressure and the decay rate of tritium, the approximate dose can be calculated, assuming the tritium concentration has reached equilibrium.

Many effects of radiation on polymers are accentuated by oxygen. Protecting polymers from oxygen or air will likely lengthen the lifetime of polymers exposed to tritium. Also, temperatures above about 120°C accelerate radiation effects in polymers, so the temperature of any polymer parts should be kept as low as possible. Inert additives such as glass or graphite generally enhance the resistance of polymers to radiation. Addition of antioxidants may also enhance radiation resistance.

5.1.3.a Plastics

VespeI™, a polyamide, has been successfully used for valve stem tips in some tritium laboratories. Ultra-High-Molecular-Weight polyethylene (UHMWPE) and High Density Polyethylene (HDPE) have been used for valve stem tips in automatic valves. Quantitative data still needs to be accumulated on the effectiveness of all of these materials. Success as a stem tip material, particularly UHMWPE and HDPE, have been overstated in the past as described in EH Technical Notice 94-01, "Guidelines for Valves in Tritium Service."

Low-Density polyethylene (LDPE) is very permeable by tritium and tritiated water and should not be considered for use in tritium systems. Polytetrafluoroethylene (PTFE, a trade name is Teflon™) degrades and decomposes in tritium, thus resulting in HF and HCl. In humid air, hydrochloric and hydrofluoric acid are then formed, which are highly corrosive. Generally, chlorofluorocarbon

polymers should not be used in tritium service. Polyvinyl chloride (PVC) and vinylidene chloride (Saran) are among several polymers used in tritium protective clothing, but should not be used for process equipment because they contain chlorine.

5.1.3.b Elastomers

Tritium readily permeates into and diffuses through elastomeric materials and, depending upon thickness, begins appearing on the outside of the elastomeric seal within hours after exposure to tritium. Elastomers are subject to radiation damage due to exposure to tritium and harden and lose their sealing ability due to exposure to high concentrations of tritium.

Ethylene propylene diene monomer (EPDM) elastomers are employed for low-pressure process flange gaskets because of EPDM is relatively good performance in tritium service. In some cases, Buna-N process flange gaskets are being replaced by EPDM when the gaskets are changed; however, in other applications Buna-N remains in use. Viton™, a common O-ring material, is used, but can embrittle in months in tritium service. Butyl rubber has low permeation for both tritium and tritiated water, but is not as resistant to radiation damage as EPDM. Butyl rubber is used for glovebox gloves. Water vapor in the air outside gloveboxes permeates gloves and can lead to a significant portion of the residual tritiated water vapor in tritium gloveboxes.

Kel-F™ is a common chlorofluorocarbon polymer and is incompatible with tritium. It, like Teflon™, degrades in tritium gas and should not be used.

5.2 First Wall Design

5.2.1 High-Pressure Tritium

For high-pressure tritium, it is generally recommended that the first wall be of all metal construction and hydrogen compatible materials including valves, valve seats, and tubing. The use of non-hydrogen-compatible materials will result in material failure and the release of the contained tritium. Elastomers are not tritium compatible, and, as a result, elastomeric seals and valve seats are not recommended for use in the containment of high-purity tritium. There are exceptions to this general case, and other criteria may be used when justified by analysis.

5.2.2 Low- and Medium-Pressure Tritium

For the containment of low- and medium-pressure, high-purity tritium, it is generally recommended that the first containment wall be of all metal construction of hydrogen-compatible materials where possible, including valves, valve seats, and tubing. Hydrogen and helium embrittlement of the materials of construction is not usually significant at low and medium pressures. As a result, non-hydrogen-compatible materials may be used if required by the design or if the required component is not available in other materials. Again, elastomers are not tritium-compatible, and, as a result, elastomeric seals and valve seats are not recommended for use in the containment of high purity tritium. There are also exceptions to this general case, and other criteria may be used when justified by analysis.

It is difficult to design a vacuum system, which in some cases is the first wall, without including some non-hydrogen-compatible materials and elastomers. However, embrittlement of the materials is not an issue because the tritium exposure is transient and the pressure is low. Under these conditions, the elastomers are not exposed to tritium continuously, and most can be used in

tritium operations under this condition. Surveillance and/or preventive maintenance schedules should be selected in order to maintain elastomer functionality.

5.3 Secondary Wall Design

5.3.1 High-Quality Secondary

The design requirements for a high-quality secondary wall are the same as the primary wall. If the secondary wall is required to provide long-term containment of high concentrations of tritium, it should meet the same requirements as the primary or first wall container.

5.3.2 Medium-Quality Secondary

If the secondary wall is a glovebox and only contains tritium that has been diluted by the glovebox gases for a short duration (a few hours), e.g., while the glovebox is cleaned up by the tritium removal system, then the requirements can be relaxed. Although the quantity of tritium contained may be quite large, the low pressure and concentration of tritium will not result in material failure due to tritium exposure.

5.3.3 Low-Quality Secondary

If the secondary wall is a room or building and only contains tritium that has been diluted by the air contained in the room or building while the room or building is cleaned up by the tritium removal system, then the construction requirements can be relaxed. Although the quantity of tritium contained may be quite large, the low pressure and concentration of tritium will not result in material failure.

5.4 Cleanup System Design

Most of the components of the tritium removal and cleanup system are only exposed to tritium at low concentrations and pressure for short time periods. The only long-term exposure is in the water collection system where the water is collected at low pressure on a molecular sieve. All metal construction is recommended, but the materials of construction are not required to be hydrogen-compatible materials. Where appropriate, elastomeric sealing materials have been used successfully in these systems for many years without significant problems. When possible, metal seals should be used because they are more durable and reliable and require less maintenance than elastomeric seals.

To minimize the potential for the generation of mixed waste and to decrease radiation exposure of the workers, oil-free pumps should be used where possible.

5.5 Storage System Design

Storage systems must consider the total cost of the storage cycle and the purpose for the storage. Storage techniques that increase the complexity of the handling process without adding beneficial features should not be used. The barrier concept discussed in Sections 4.1.1 through 4.1.3, in addition to the wall design considerations discussed above, should be incorporated into all storage system designs.

5.5.1 Short-Term Storage

Tritium used to support the day-to-day activities in a facility must be readily available to the facility customers. If the facility uses tritium in gaseous form and its decay to helium does not impact the process, then, to simplify the operation and the equipment, the tritium can be stored in gaseous form. The storage container should be fabricated of all metal, hydrogen-compatible materials including valves, valve seats, and seals.

5.5.2 Medium-Term Storage

If tritium is only used in periods of two years or less, the requirements do not change significantly from those of short-term storage. Experience has shown that tritium can be stored safely at near atmospheric pressure for long periods of time. If the buildup of helium in the supply does not impact the use, then storage as a gas is an acceptable alternative. There are, however, advantages of tritide bed storage for medium-term use. Impurities such as nitrogen and oxygen form uranium nitride and uranium oxide and are removed from the gas stream as the bed is heated and cooled. Helium, which accumulates due to the decay of tritium, and any other impurities remain in the overpressure gas above the bed and may be pumped off after the bed had been cooled down and the tritium has been gettered by the uranium. As a result, the uranium bed not only provides for tritium storage but also provides a means of maintaining a reasonably pure and stable tritium supply.

5.5.3 Long-Term Storage

Due to the half-life, storage of tritium for several years implies that it is not readily needed. It should be placed in a safe and stable condition while the tritium decays.

5.5.3.a Storage as a Gas

Compared to the fabrication and preparation of metallic storage beds, regardless of what metal is used, the cost of storage of tritium as a gas at near atmospheric pressure is economical. ASME-code-designed stainless steel tanks are available or can be designed and fabricated at a reasonable cost. A tank at atmospheric pressure would end with a final of 15 pounds per square inch gauge (psig) pressure after all of the tritium had decayed, so embrittlement is not an issue. The long-term storage of hydrogen and tritium in containers is well understood in comparison to the understanding of long-term storage of metal tritides.

5.5.3.b Storage as a Metal Tritide

Uranium beds designed at Sandia in the late 1970s for laboratory use were about the size of two one-gallon paint cans. This included the secondary containment system and electric heaters used to drive the tritium off during tritium removal. These beds were designed to store 50 grams of tritium as uranium tritide that was easily recoverable in a matter of less than an hour. Long-term storage in this type of container is expensive, but the tritium can be easily and quickly recovered for use. Additionally, large uranium beds capable of storing kilogram quantities are possible, and would significantly decrease the volume required to store large quantities of tritium. Also, impurities such as nitrogen and oxygen form uranium tritide and uranium oxide, and are removed

from the gas stream as the bed is heated and cooled. Helium, which accumulates due to the decay of tritium, and other non-reacting impurities remain in the overpressure gas above the bed.

To help resolve unknowns regarding consequences of air-ingress accidents in uranium beds, a series of air-ingress experiments was conducted at Ontario Hydro Research Division, with the participation of Princeton Plasma Physics Laboratory (PPPL) and the Idaho National Environmental and Engineering Laboratory. The experiments indicated that the resulting reaction was restrained with only modest temperature excursions. This leads to the conclusion that the hazards associated with an air-ingress accident involving a uranium bed is smaller than previously anticipated. Additionally, tests conducted by WSRC indicate that, except for catastrophic container failure, the tritium release due to air inleakage into a uranium tritide bed is limited by diffusion.

Titanium hydride is not pyrophoric at room temperatures, is a stable material, and has been studied for use in the long-term storage of tritium. It is reported to be less prone to spontaneous ignition in air than the parent metal. Following the hydriding process, if the titanium hydride is exposed to air under controlled conditions, a small quantity of hydrogen is released from the material as the oxide layer forms on the surface of the material. Following formation of the oxide layer, titanium hydride is stable in air. Hydrogen will not be released unless the material temperature is significantly increased.

Palladium tritide is not pyrophoric at room temperature, is a stable material, and the overpressure of tritium over the bed at room temperature is approximately 50 torr.

Metal tritides have the advantage of significantly decreasing the volume required to store tritium without increasing the pressure of the gas during storage.

5.6 Surveillance and Maintenance

The level of equipment surveillance (including radiological monitoring) and maintenance required is based on the hazard class of a facility; i.e., Hazard Category I through III or Radiological. The specific requirements for the different classes of facility equipment are a function of the safety issues associated with the equipment. These are specified in the facility safety analysis report or other facility safety documentation and in the facility maintenance plan.

5.7 Seismic Considerations

This section describes 1) DOE Natural Phenomena Hazards Policy, which defines the requirements for protection against natural phenomena such as earthquakes, and 2) Seismic Design and Evaluation of Equipment and Distribution Systems. Seismic and Wind Design and Evaluation of Structures and Facilities are discussed in Section 4.4.

5.7.1 DOE Natural Phenomena Hazards Policy

The DOE has developed a policy for the mitigation of natural phenomena (such as earthquakes, extreme winds, and floods) on its facilities. This policy is in the form of an Order, an Implementation Guide, and a series of Standards. DOE Order 420.1 and its Implementation Guide provide the overall requirements for mitigation of the effects of natural phenomena. The Standards lay out the basic performance requirements for structures, systems, and components (SSCs) subjected to loads caused by earthquakes, extreme winds, and floods.

The approach in the DOE policy consists of placing each SSC into a PC based on its function, its importance to safety, and the quantity and type of material involved, if any. DOE-STD-1021-93, Change Notice 1 provides guidance for categorizing SSCs. Background material used in the development of DOE-STD-1021-93 can be found in UCRL-ID-112612. The Standard provides useful dose information for radiological materials and toxic chemicals. Additional information that is useful in determining categorization results from accident analyses, information from a safety analysis report, and information in support of DOE-STD-3009. An equipment list will be developed with the PC for each SSC identified.

DOE policy invokes DOE-STD-1022-94, Change Notice 1, "Natural Phenomena Hazards Characterization Guide," and DOE-STD-1023-95, Change Notice 1, "Natural Phenomena Hazards Assessment Criteria," if any SSC is categorized as a PC3 or PC4. These Standards define acceptable procedures to determine levels of the natural phenomena hazards at the site for use in design or evaluation. If only PC2 or lower SSCs exist at the site, then Uniform Building Code (UBC) design values are acceptable. However, site-specific values are always preferable if they are available.

Design and evaluation criteria are provided in DOE-STD-1020-94, Change Notice 1. This handbook provides an acceptable approach for the design and evaluation of SSCs in PCs 1, 2, 3, and 4. The design basis earthquake and wind can be developed from the available natural phenomena hazard description, either site specific or from the UBC. A table of representative seismic and wind design values for most DOE sites is contained in DOE-STD-1020-94, Change Notice 1. Use of the values in DOE-STD-1020-94, Change Notice 1 must be justified for the site. DOE-STD-1020-94, Change Notice 1 also discusses the 5 percent damped in-structure response spectra, which is used for the design and evaluation of equipment. These spectra must be developed from the description of the ground motion and the facility characteristics.

The user should review these standards, the appendices in the standards, and the references listed below and be aware of the type of information provided therein. DOE has conducted training on the use of the design and evaluation standard since 1989, and copies of the training material are also available.

5.7.2 Seismic Design and Evaluation of Equipment and Distribution Systems

In the event of an earthquake, DOE facilities need to have adequate measures for the protection of the public, workers, environment, and investment. Due to the evolutionary nature of design and operating requirements as well as developments in engineering technology, existing DOE facilities embody a broad spectrum of design features for earthquake resistance. These features depend on factors such as vintage of the facility design and construction and hardware supplier practices at the time of design and construction. The earliest vintage facilities often have the least design consideration for seismic-induced forces and displacements and exhibit the greatest difference between their design basis and current requirements for seismic design criteria for new facilities. DOE has developed a Seismic Evaluation Procedure (SEP) to summarize a technical approach and provide generic procedures and documentation requirements, which can be used at DOE facilities to evaluate the seismic adequacy of equipment and distribution systems.

The SEP is intended to provide DOE facility managers, safety professionals, and engineers with a practical procedure for evaluating the seismic adequacy of equipment. Often the approach used to review the seismic capacity of equipment in facilities is to conduct sophisticated evaluations, which can be very time consuming, complex, and costly. Much of the available funding and time can be spent on analysis rather than on the real objective of increasing the seismic capacity of the

equipment. The SEP is designed to be an extremely cost-effective method of enhancing the seismic safety of facilities and reducing the potential for major economic loss that can result from equipment damaged by an earthquake.

The following is a suggested list of topics to consider in the design of new systems and equipment or the evaluation of existing systems and equipment. Representative equipment that may be found in tritium facilities is listed in Table 5-1.

The PC for each system or component to be reviewed must be defined, (PC 1, 2, 3, or 4) in the Seismic Equipment List (SEL). The methodology and procedures for evaluating the seismic adequacy of equipment described in the SEP are based on the observed performance, failure, and response of various types of SSCs during and after they were subjected to either actual or simulated earthquake motion. An SSC in a DOE facility can be evaluated for seismic adequacy provided that the associated guidelines, limitations, requirements, and caveats described in the SEP are satisfied.

TABLE 5-1. Representative equipment found in tritium facilities

<p>ELECTRICAL EQUIPMENT</p> <ul style="list-style-type: none"> Batteries on Racks Motor Control Centers Low- and Medium-Voltage Switchgear Distribution Panels Transformers Battery Chargers and Inverters Instrumentation and Control Panels Instruments on Racks Temperature Sensors Computer Data / Storage Systems Alarm Instrumentation Communications Equipment <p>PIPING AND RACEWAY SYSTEMS</p> <ul style="list-style-type: none"> Cable and Conduit Raceway Systems Piping HVAC Ducts Underground Piping Underground Raceways Stacks Conveyors of Material <p>TANKS</p> <ul style="list-style-type: none"> Vertical Tanks Horizontal Tanks and Heat Exchangers Underground Tanks Canisters and Gas Cylinders Miscellaneous Tanks 	<p>MECHANICAL EQUIPMENT</p> <ul style="list-style-type: none"> Fluid-Operated / Air-Operated Valves Motor/Solenoid-Operated Valves Horizontal Pumps Vertical Pumps Chillers Air Compressors Motor-Generators Engine-Generators Air Handlers Fans HEPA Filters Gloveboxes Miscellaneous Machinery <p>ARCHITECTURAL FEATURES</p> <ul style="list-style-type: none"> Unreinforced Masonry (URM) Walls Hollow Clay Tile Walls Suspended Ceilings Raised Floors Storage Racks Cranes Elevators <p>SWITCHYARD AND SUBSTATION EQUIPMENT</p> <ul style="list-style-type: none"> Power Transformers Miscellaneous Equipment
--	---

The general approach for the development of the SEL is envisioned to be a three-step process as depicted in Figure 5-1. After a SEL Team is selected, the first step of the process is the development of the preliminary SEL from a list of the facility SSCs. The SEL Team consists primarily of safety professionals and systems engineers with assistance from seismic engineers and facility operators. Only a portion of the facility SSCs will be contained in the SEL and, in many cases, the SEL will contain only safety-related SSCs that must function during or after a seismic event. The selection of the SSCs belonging on the SEL should be based on the results of accident

analyses. These accident analyses should consider the appropriate facility hazards as required by DOE Orders and Standards.

For the DOE facility being seismically evaluated, accident analyses and their results are typically provided in a SAR. The preliminary SEL should be based on information provided in this SAR. For a nonreactor nuclear facility, DOE-STD-3009 provides guidance on the preparation of a SAR. Using the guidance in DOE-STD-3009 and the appropriate accident analyses in the SAR, SSCs can be differentiated into Safety Class or Safety Significant, and the preliminary SEL can focus on those facility SSCs. For facilities without a SAR, accident analyses comparable to those required for a SAR should be performed.

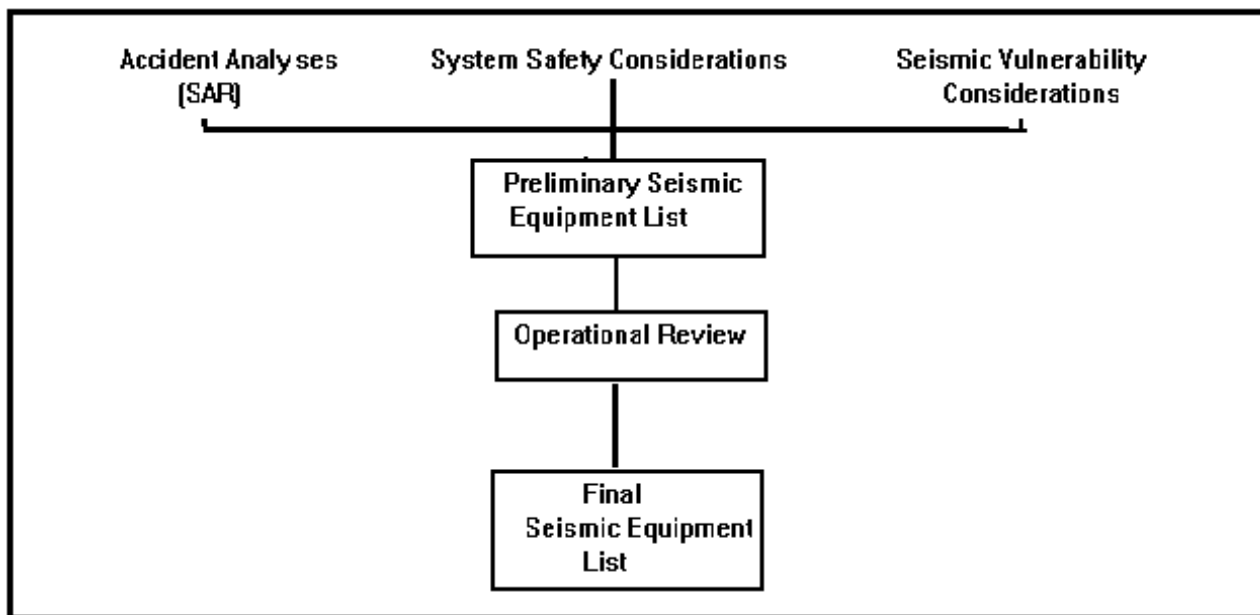

FIGURE 5-1. Development of the seismic equipment list

Additional guidance for the development of the preliminary SEL is provided in DOE-STD-1021. This Standard considers the results of facility hazard classification, SSC safety classification, and performance categorization. With these considerations, the facility SSCs are assigned to the appropriate performance category. The preliminary SEL focuses on those SSCs that are classified above a specified performance category. In addition to selecting SSCs based on a SAR or DOE-STD-1021, there are system safety considerations and seismic vulnerability considerations that should be addressed when developing the preliminary SEL.

Next, the location of equipment items in the facility and in-structure response spectra for this level or location are determined. The in-structure response spectra represent the modification of the ground response spectra by the facility. There may be amplification or attenuation of the motion at various frequencies at different locations within the facility. As discussed in DOE-STD-1020-94 (CH-1), the 5 percent damped in-structure response spectra is used for design or evaluation of equipment at a specific location. Guidance for determining in-structure response spectra is provided in the Standard. To evaluate equipment and distribution systems, the following items should be considered:

- **Functionality Requirements**
 - Does the item need to function during the earthquake?
 - Does it need to function only after the earthquake?
 - Can it be placed back into service by operator actions?
- Does the item have sufficient capacity to meet the earthquake demand specified for its PC? An example of a comparison of capacity to demand is shown in Figure 5-2.
- Is the item adequately anchored or braced? There are special considerations for base-isolated or vibration-isolated items since they have behaved poorly during earthquakes.
- Does an adequate “Load Path” exist to transfer all seismic loads in addition to operating loads? A load path is a continuous path, which carries load from the top of a structure or component down through an element and finally into the foundation. Loads produced by the earthquake must be combined with normal operating loads such as weight, pressure, temperature, and any temporary loads that may exist.
- Are there system interaction issues?
 - Can something fall and cause the item not to function?
 - Can the item impact with nearby items?
 - Is there differential motion between the item and the structure?
 - Is there a water spray or flood issue?
 - Is there a fire issue?

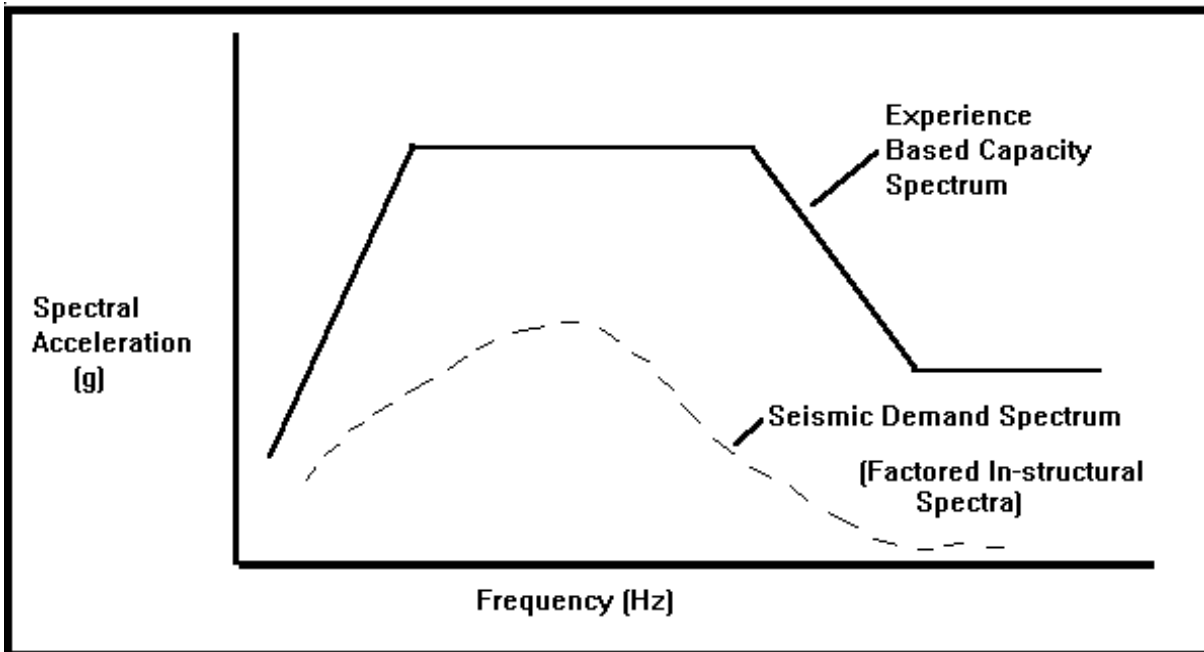

FIGURE 5-2. Comparison of seismic capacity spectra to seismic demand spectra

Each new system or new component must be designed to meet the DOE seismic criteria specified in DOE Natural Phenomena Policy as specified in Section 4.4. Adequate documentation to support its design must be maintained by the facility management. Adequate inspection should be

conducted to make sure the system or component was fabricated and installed as specified in the design documents. Documentation must be maintained current throughout the life of the item.

Evaluation of existing systems or components must be conducted based on the "Actual" condition of the item. This may be different than the design or "As-Built" condition due to field modifications or deterioration of the item during its service. An examination of the item, its installation, and current condition should be made during a walkdown by seismic engineers as defined in the SEP. Existing systems and components may also be evaluated by use of experience data. This is an alternative approach that can be used if the systems or components are installed in an acceptable manner and meet the rules specified in the SEP to ensure that the item is similar to items in the experience database. DOE has developed resources for the evaluation of existing systems and components, has conducted training on their application, and has been implementing the development of seismic evaluation guidelines for systems and components at DOE facilities.

5.8 Fire Scenarios

There have been recent investigations that point to the conclusion that fire scenarios are the dominant risk at most tritium facilities. These fire scenarios are not restricted to seismic-induced fires, but include fires from all sources. These recent analyses show that the slower burning fires are limiting, and that in almost all cases, these fires result in oxidation rates that are high (in excess of 90%). Additionally, compliance with National Fire Protection Association (NFPA) requirements, while limiting the potential for fire spread, does not ensure that a full-facility fire scenario need not be analyzed. Reference [26] describes the latest findings in this area.

It is possible that fires of sufficient magnitude and frequency exist at some tritium facilities so as to warrant safety system classifications of both the fire suppression and fire detection systems. It has long been the position of EH-3 that tritium fire suppression and detection systems should be classified as safety systems (at a minimum as safety-significant, and in some cases as safety-class (e.g., where other safety-class equipment operation is contingent upon fire system operation or where fire scenarios result in unacceptable public dose)), unless documented analyses such as the FHA or the SAR justify non-classification. This importance that EH-3 places on fire protection at tritium facilities was highlighted as early as September 1991 during a review of the then-under-construction RTF. The exemption request from some requirements of DOE Orders 5480.7 and 6430.1A for RTF were not approved by EH/NS until physical modifications were made to the tritium facility. [27]. The definition of tritium that was Material at Risk in selected fire (and seismic) scenarios was also developed prior to startup at RTF, which eventually led to decisions on upgraded selected storage containers and inventory limits. [28]

5.9 Instrumentation

This section provides information on several instruments used to detect and monitor tritium. The references are provided for information only. DOE does not certify that a particular product is superior to any other product from another vendor. References in this Handbook do not imply endorsement by DOE.

5.9.1 Tritium Monitoring Systems

Several different types of instruments may be used to detect and measure tritium in the operation of a facility. Examples and a discussion of such instrumentation follow:

- Ionization Chambers — Tritium decays to ^3He by the ejection of a beta particle. The beta particle generated by the decay of tritium ionizes the surrounding gas. The number of ions produced due to the loss of energy of the beta particle is a function of the type of gas. A sample of gas is collected in the ionization chamber and the ionization current is measured. The resulting chamber ionization current is proportional to the quantity of tritium in the gas. The larger the measuring chamber volume the higher the output current and the easier it is to measure. However, as the volume of the chamber increases, the longer it will take to get an accurate measurement. Modern electronic systems have solved most of the problems associated with measuring small ionization currents in small volumes and as a result, the volume of the ionization chambers has been reduced over the years from 50L down to 1 or 2L. Most tritium measuring instruments have an ionization chamber.
- Proportional Counters — Gas proportional counters are also used to measure the amount of tritium contained in a gas. A sample of the gas to be monitored is mixed with a counting gas and passed through a proportional counter tube where the pulses caused by the decay of tritium are counted. Proportional counter monitors can be used for most gas monitoring applications and are also available to measure surface contamination.
- Scintillation Crystal Detectors — Scintillation detector systems are used to measure the total mole percent of tritium in a sample of gas independent of the chemical composition of the tritium in the gas (HT, DT, T₂, and CH_xT_y). A sample of the gas is introduced into a measurement chamber at low pressure, generally less than a few torr. The chamber contains a scintillation crystal, which is exposed to the tritium as it decays. The light pulse produced in the scintillation crystal is either counted or is used to produce a current, which is proportional to the mole percent tritium contained in the gas sample. Crystal scintillation detection is generally used to measure the mole percent of tritium in gases containing high concentrations of tritium.
- Mass Spectrometer — Magnetic sector, quadrupole, and drift tube mass spectrometers are used as analytical tools to measure the individual components that make up the gas being measured. Mass spectrometers are generally used for the purposes of assay and accountability or for scientific purposes. A sample of the gas to be measured is introduced at low pressure (a few microns) into a chamber and ionized. The ions produced are then measured by a means that discriminates on mass. The number of ions produced at each mass is measured and is proportional to the partial pressure of the component in the gas sample.

The sophistication of the measurement systems varies greatly from facility to facility through out DOE. Light isotope, drift tube, mass spectrometers require a large capital investment and require a skilled staff to operate, and, in some cases, may not be cost-effective. All DOE tritium facilities do not require a light isotope drift tube mass spectrometer. Quadrupole mass spectrometers and crystal scintillation detectors are much less expensive, but still require operation by knowledgeable well-trained personnel. The DOE assay and accountability requirements and regulations do not currently reflect this difference in sophistication and cost and currently place the same requirements on small as well as large-scale operations.

- Liquid Scintillation Counters — Due to the need to measure the removable tritium on surfaces and in the body water of workers, almost all tritium facilities are equipped with or have access to a liquid scintillation counter. If the scintillation counter is not available on site the service can generally be purchased from a local firm. Liquid scintillation counters are used to measure the quantity of tritium on surfaces, in liquids, and in dissolved samples. For removable surface contamination measurements, a wipe of the surface to be measured is taken using dry paper

or a Q-Tip. The filter paper or Q-Tip is then placed in a scintillation cocktail, and the quantity of tritium is measured by counting the light flashes that occur in the scintillation cocktail as the tritium decays. The surface contamination is then calculated in units of dpm/100 cm².

For liquid measurement, a sample of the liquid to be measured is placed in the liquid scintillation cocktail and measured. The tritium concentration of the liquid is calculated in Ci/mL. For solid measurement, a known weight of a material is dissolved to produce a liquid and then the liquid is sampled and measured in the scintillation counter. The quantity of tritium is then calculated in units of Ci/g of the original solid.

- Gas Samplers — Many different types of gas samplers have been developed and used for measuring very small quantities of tritium in very large volumes of gas. These samplers are used to measure quantities of tritium released through a facility stack and for environmental monitoring at a site. Stack exhaust gas monitoring systems generally use an ionization chamber to measure the tritium in the stack gases and a gas sampler to measure the extremely low levels of tritium that cannot be measured by an ionization chamber.

Most of the stack gas samplers are patterned after the ethylene glycol sampling system developed at Mound Laboratories. A commercial version of this system is now available. In this system, a sample of gas from the stack is circulated through six ethylene glycol bubblers in series. The first three bubblers remove tritium in the form of HTO, DTO, and T₂O. The gas stream is passed through a heated catalytic reactor where tritium in the form of HT, DT, T₂, and CH_xT_y, is cracked and oxidized to form water. This sample is then passed through three more ethylene glycol bubblers to remove the tritium gas, which is now in the form of water. After a period from a few hours to days, a sample of the ethylene glycol from each bubbler is removed and counted using a scintillation counter to determine the quantity of tritium in each bubbler. Tritium recovered from the first three bubblers is proportional to the tritium in liquid form contained in the stack gases and the tritium recovered in the last three bubblers is proportional to the quantity of tritium in gaseous form contained in the exhaust gases.

Due to the extremely small quantity of tritium contained in the atmospheric gases surrounding a tritium facility, the environmental gas samplers use higher flow rate sampler systems than those required for stack monitoring, and, in general, collect the water on molecular sieve traps. The water collected on the molecular sieve traps is then recovered from the trap and the tritium concentration of the gas passing through the trap is calculated from the tritium concentration of the collected water, the gas flow rate through the trap, and the sampling time.

- Portable Room Air Monitors — There are several hand held portable room air monitors on the market and their capabilities and ranges vary as a function of the different manufacturer and the purpose for which they were designed. It is convenient in some activities to have the capability to connect a small hose to the monitor so that it may be used to detect tritium leaks around equipment.
- Fixed Station Room Air Monitors — Fixed station monitors are designed to be installed in fixed locations and to be used to monitor the room air tritium concentrations. Depending upon the manufacturer they may have several ranges and are equipped with one or two alarm set points and audible as well as visual alarms.

- Glovebox Atmosphere Monitors — Glovebox monitors may be open mesh or closed ionization chambers and are designed to monitor the higher levels of tritium inside the glovebox containment systems.
- Hood and Exhaust Duct, Air Monitors — Hood and exhaust duct air monitors are similar to fixed station monitors in range and characteristics.
- Exhaust Stacks, Air Monitors — Exhaust stack monitors are similar to fixed station air monitors except that they generally have larger ionization chambers to increase the sensitivity of the monitor.
- Personnel Friskers and Breath Analyzers — There has been some interest in instruments which can be used to frisk personnel as they enter and exit tritium contaminated areas. One DOE facility implemented a process of personnel frisking consisting of the use of skin surface wipes counted in a liquid scintillation counter upon entry and exit from tritium contaminated areas. In another facility, a hand station based on counting the associated gas flow across the hands was used. To date, the development work required to relate measurements made by these techniques to dose or worker exposure has not been completed. It is expected that differences in the body chemistry of personnel and differences in the time delay between tritium exposure and equilibration of tritium in the body will continue to make the results of skin surface contamination measurement and breath analysis monitoring inconsistent. The impact of false alarms and inconsistent results on worker confidence will probably continue to make these systems unsatisfactory for worker monitoring.

5.9.2 Specialized Instrumentation

There are many other types of specialized devices and/or instrumentation vendors, and some may be superior to those discussed here. No endorsement of these devices should be inferred by the reader. A more expansive discussion is planned for the next revision of this Handbook.

5.9.2.a Remote Field Tritium Analysis System

A prototype system for the remote, in situ analysis of tritium in surface and ground waters has been developed at SRS. Using automated liquid scintillation counting techniques, the Field Deployable Tritium Analysis System (FDTAS) has been shown in laboratory and field tests to have sufficient sensitivity to measure tritium in water samples at environmental levels (10 becquerels (Bq)/L [~ 270 pCi/L] for a 100-minute count) on a near-real-time basis.

The prototype FDTAS consists of several major components: a multi-port, fixed volume sampler, an on-line water purification system using single-use "tritium columns," a tritium detector employing liquid scintillation counting techniques, and the serial communications devices. The sampling and water purification system, referred to as the "autosampler," is controlled by a Programmed Logic Controller pre-programmed to perform a well-defined sampling, purification, and flushing protocol. The tritium analyzer contains custom software in the local computer for controlling the mixing of the purified sample with liquid scintillation cocktail, counting, and flushing the cell. An external standard is used to verify system performance and for quench correction. All operations are initiated and monitored at the remote computer through standard telephone line modem communications. [29]

5.9.2.b Surface Activity Monitor

A new surface activity monitor (SAM) for measuring tritium on metal (electrically conducting) and non-metal (electrically non-conducting) surfaces has been recently developed at Ontario Hydro Technologies. [30-32]

The monitor detects tritium on the surface and in the near-surface regions by virtue of primary ionization in air due to the outward electron flux from the contaminated surface. The resulting ion pairs are measured by imposing an electric field between the contaminated surface and a collector plate. A simple theoretical model relates the total tritium concentration on a surface to the measured current.

Experiments benchmarking the application of the surface activity monitor on metal surfaces against independent measurement techniques of aqueous dissolution and thermal desorption show equivalence in the total tritium activities measured. Comparison of surface activity monitor measurements with the dry polystyrene smear protocol has shown that the two methods are complementary. Smearing measures the activity removed by the smear action, which can be used to infer the total activity on the surface. Surface activity monitor measurements determine the total activity on the surface, which can be used to infer removable activity. Ontario Hydro has stated that this device is the only surface monitor for tritium that provides an absolute measurement of the total activity on metallic surfaces.

Experiments demonstrating the application of the surface activity monitor on a variety of non-conducting surfaces have been conducted. Some of the non-conducting surfaces examined include paper, concrete, granite, and wood. Experiments are underway to extend the database of non-conducting materials measured by SAM and catalogue the associated collection efficiencies.

Currently, the SAM is commercially available in two models, QP100 and QP200, which have measurement ranges of 0 - 200 nCi/cm² and 0 - 200 µCi/cm², respectively. A summary of the technical specifications of the instrument is given in Table 5-2.

5.9.3.c Breathalyzer

A device undergoing development in Canada is the Scintrex Tritium-In-Breath Monitor. It is an automatic monitor dedicated towards health physics and radiation biology applications. The Tritium-in-Breath Monitor measures levels of exhaled tritium within 5 minutes of sampling, thus saving considerable time and effort in the monitoring process. This rapid assessment has a sensitivity level of 5µCi/L-urine equivalent, which may be sufficient for alarming the cautionary levels of in-body tritium. Preliminary development of this equipment has been done at the Atomic Energy of Canada Ltd. research laboratory in Chalk River, Canada.

TABLE 5-2. SAM technical specifications

	Model QP 100	Model QP 200
Detection Sensitivity	740 Bq/100 cm ² (0.2 nCi/cm ²) (440 dpm/cm ²)	740 kBq/100 cm ² (0.2 μCi/cm ²) (440 kdpm/cm ²)
Ranges	0-74 kBq/100cm ² (0-200 nCi/cm ²)	0-74 MBq/100cm ² (0-200 μCi/cm ²)
Measurement Area	9 cm ²	
Signal Display	3½ digit LCD	
Instrument Response Time	Less than 15 seconds	
Operating Time	500 hours continuous service	
Operating Temperature	15 - 60°C	
Air Pressure	600 – 120 kPa	
Humidity	5 – 65 percent RH	
Change in Off-Set	0.04 nCi/cm ² /°C over 5°C to 30°C	
Dimensions: Footprint Height	5.8 cm diameter 14.2 cm	
Weight	575 g	
Accessories	Calibration surface activity sources Verification surface activity source Reusable boots to eliminate cross contamination Battery pack	

6.0 TRITIUM PURCHASING AND RECEIVING

In the past, DOE has been a commercial supplier of tritium to industry. DOE ceased commercial sale of tritium at the end of fiscal year (FY) 1995 and now only supplies tritium to DOE-operated facilities. There is no charge to DOE facilities for the tritium. Costs may be incurred for the shipping container, the loading and shipping of the container, and any other incidental costs associated with shipping tritium from the supplying facility to the user. While it is advantageous to transport tritium in a metal hydride vessel, the receiving sites must be equipped with appropriate furnace capability.

6.1 Shipping Packages

The packages for shipment of tritium must meet regulatory requirements based on the amount of tritium being transported. The design requirements for radioactive materials shipping packages are specified in 10 CFR 71.43 and 49 CFR 173.410. See Section 7.2.3, Minimum Requirements for Packaging, for the basic shipping container design requirements.

6.1.1 Type A Shipping Packages

Type A quantities (< 1,080 curies) of tritium may be shipped in DOT 7A Type A shipping packages. DOE/RL maintains a manual, "Test and Evaluation Document for the U.S. Department of Transportation Specification 7A Type A Packaging" (formerly WHC-EP-0558) that lists

approximately 15 packages that meet 49 CFR 178.350 for the transportation of Type A quantities of liquid or gases. Additionally, several commercial manufacturers will design packages that meet these radioactive materials shipping criteria.

6.1.2 Type B Shipping Packages

Tritium in Type B quantities (> 1,080 curies) is shipped in the form of uranium tritide in the WSRC-developed Hydride Transport Vessel (HTV). If the tritium is in gaseous form, it is shipped in the WSRC-developed Product Vessel (PV). LP50 containers are no longer used. The HTV and PV can be packaged for shipment in the Type B, UC-609 shipping package. Primary containers other than the HTV and PV can also be shipped in the UC-609. However, if tritium is ordered from or is to be returned to a DOE facility, it is generally shipped in an HTV or PV if packaged inside the UC-609. For design and analysis purposes, the storage vessel receives no credit for tritium containment. The package can be transported as non-exclusive (i.e., with other than radioactive cargo) use by highway, rail, water, or air.

Type B quantities may also be transported from one DOE site to another in the Sandia-designed H1616 shipping package. DOE authorization is required before using the H1616 package. The primary tritium container enclosed inside the H1616 must meet the Sandia National Laboratory (SNL) specification SS393217. The HTV is qualified for shipment in the H1616 packaging and meets the SNL specification [33]. Of the two H1616 variations, H1616-1 and H1616-2, qualification for transport in the H1616-1 automatically includes qualification for transport in the H1616-2. The next revision to this handbook is planned to include relevant information on the H1616 design, operational procedures, packaging and shipping requirements, and limitations on use.

Caution should be exercised when shipping “empty” HTVs, as the residual heel may contain > 1080 curies, thereby requiring a Type B shipment for the “empty” HTV.

6.2 Product Containers

6.2.1 WSRC, Product Vessel

The WSRC PV is designed for use with the UC-609 to ship up to 10 grams of gaseous tritium in a single valve, 21L-volume container at pressures up to 1,200 torr. The PV is designed to meet the requirements of the ASME Boiler and Pressure Vessel Code, Section VIII, Division 1, 1991 Addenda, Lethal Service, Full Vacuum to 8.5 psig (1,200 torr) at 77°F.

Although the PV is designed to meet ASME code requirements, the PV is not ASME code stamped. The vessel is equipped with a single valve, Nupro® SS-4HS-TW valve, 316 SS body and is closed with a male Cajon® SS-4-VCR-4 nut and a Cajon® SS-4-VCR-CP cap.

6.2.2 WSRC, Hydride Transport Vessel

The HTV [33] can be loaded with a maximum of 3 moles (18 grams) of tritium as uranium tritide. The main body of the HTV is fabricated from two four-inch Schedule 40 pipe caps, welded together and contains a free volume of approximately 690 cubic centimeters. The HTV weighs 9.3 pounds, has a maximum outside diameter of 4.560 inches, and is 9.980 inches high. The HTV is equipped with two ports with a single Nupro® SS-4HS-TW closure valve on each port. Both ports are equipped with 2-micron nominal pore size, cup shaped, porous stainless steel filters welded on the

end of the port tube inside the vessel. The purpose of the filters is to confine the uranium powder. One filter is positioned in the volume above the uranium and is connected through a valve to the female port with a Cajon® SS-4-VCR-1 female nut. The second filter, connected through the valve to the male port, is positioned below the level of the uranium powder in the bottom of the vessel and is connected through the valve to the male port with a Cajon® SS-4-VCR-4 male nut. Both ports are used when the bed is used in a flow-through mode of operation.

The maximum normal unloading temperature is 450°C, and the maximum unloading pressure at temperature is 2.9 psia. Exceeding the 2.9 psia pressure at temperature will impact the vessel service life.

When uranium is loaded to full stoichiometry with tritium to form UT_3 , it retains the decay helium in the solid for about 300 days until the concentration of helium reaches approximately 0.134 He/U, after which, some of the helium will be released from the solid. The helium release rate increases over a period of about 600 days, until it equalizes with the helium generation rate.

The HTV Dissociation Pressure [33], P is

$$\log P_{\text{atm}} = -(4038.2/T) + 6.074$$

where T = temperature (K)

which implies

$$P_{\text{atm}} = 10^{-(4038.2/T) + 6.074}$$

The second equation for the HTV Dissociation Pressure is

$$\log P_{\text{psia}} = -(4038.2/T) + 7.2413$$

which implies

$$P_{\text{psia}} = 10^{-(4038.2/T) + 7.2413}$$

WSRC conducted several tests on the HTV to determine the impact of an air ingress incident. The results indicate that in the dehydride state, the uranium reacted with both oxygen and nitrogen in the air. The reaction stopped when the accumulation of argon and moisture in the vessel reached atmospheric pressure and prevented additional air from entering the vessel. The maximum temperature was approximately 200°C. If air is drawn through the uranium continuously, a temperature higher than 1,000°C can be reached, and damage to the vessel may occur. There are some current issues associated with HTV qualification and use that are being addressed at SRS, the results of which will be included in the next revision to this document.

6.2.3 Recommendations for Improvements for Product Containers

Both the PV and HTV containers are single-valve designs (although the HTV actually has two valves; one for filling and one for evacuating), employing an SS-4HS-TW valve. Selection of this valve was based in part on the favorable rating it received against valves of similar size. It is rated at 315°C and 1000 psig. Additionally, the valve stem tip is Stellite™ spherical design, a desirable tip configuration. Although the leak rate is verified annually at SRS, the employment of a single H-type valve close to the heat zone is not an optimal design, as described in EH Technical Notice 94-

01, "Guidelines for Valves in Tritium Service," and users should be prepared for potential leaks across the valve seat in addition to bellows leaks.

Modifications to existing designs could be incorporated into future revisions. In addition to valve overtorque protection and/or hardware upgrades, the HTV use of thin-walled SS 348 may lead to more than desired outgassing as the number of cycles accumulates. The upgrading of material or jacketed design are potential options. Other design improvements could include internal baffling and different (types, sizes, and locations) filters. An operational practice of tracking and segregating containers that are used for high-purity shipments and those used for other shipments (e.g., scrap shipments) would be beneficial in ensuring the capability to ship War Reserve gas by not contaminating the U bed with mixed isotopes.

6.3 Valve Container Operations

The use of two valves in series on containers filled with tritium that are to be disconnected from the tritium apparatus on a routine basis has been in common use for several years. When the failure of a single valve seat can result in the release of significant quantities of tritium, two valves in series should be used. If the seat of a single valve develops a leak during storage and the container port is uncapped, the tritium will be released into the containment system through the failed valve seat.

Valve seat failure is often associated with damage to the seat caused by long exposure to tritium or by misalignment resulting from improper operation or maintenance practices. Double valves are recommended in all cases where the container valve seat is exposed to tritium for long periods of time or is susceptible to misalignments. Additional guidance for tritium valve selection, operation and maintenance is contained in the Office of Nuclear and Facility Safety's Technical Notice 94-01. This document describes desirable features and material for various tritium applications and lists recommended practices.

It is assumed by experienced tritium handlers that valve seats can fail, and, therefore, the basic strategy in double-valve use is depicted in Figure 6-1 and described as follows:

- The container is connected, leak tested, and filled with the required quantity of tritium, and the second container valve is closed.
- The tritium between the second valve and the tritium supply is pumped away, and the section is isolated and monitored for pressure rise.
- If a pressure rise indicates that the second valve seat is leaking, then the container is emptied while connected to the manifold, and the valve seat is repaired.
- If no leak is detected, then the first valve is closed and the second valve is opened, and the tritium trapped between the first valve and the second valve is pumped away. This section is isolated and monitored for a pressure rise.
- If this test indicates that the first valve seat is leaking, the container is emptied, and the valve seat is repaired.
- If no leak is detected, then the second valve is closed, the container is disconnected, and the container port is capped and sealed.
- The container is transported to a new location or placed in storage as appropriate to the task.

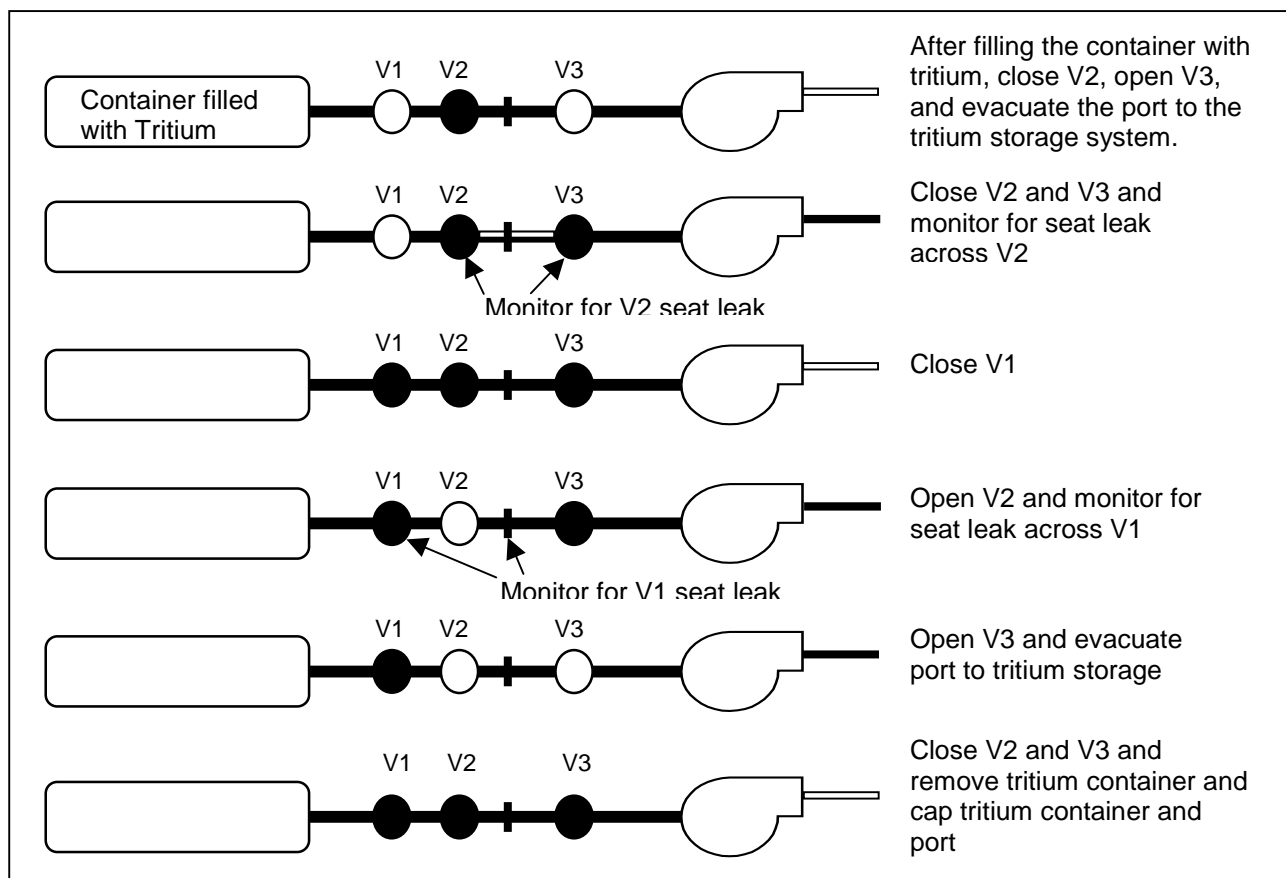

FIGURE 6-1. Use of double valve container

This leaves the container in the following condition:

- The tritium is trapped inside the container by the first valve, and the valve seat of the first valve is exposed to tritium during storage or transport.
- The space between the first valve and the second valve has been evacuated and contains no significant quantity of tritium or other gases. The second valve seat is not exposed to tritium during the storage or transport cycle.
- The space between the second valve and the container port cap contains glovebox gas or air sealed into the void space by the port closure seal.

To make a reconnection to a manifold, the following steps apply:

- Before the container is reconnected to a manifold, the two valves are checked by hand to make sure they are closed.
- The port is uncapped and connected to the manifold.
- The gas trapped in the space between the port and the manifold is pumped out, and the connection is leak checked using a helium leak detector calibrated to detect a leak of $< 10^{-6}$ cc He/second.

- If the port connection is leaking, the leak is repaired, and the leak test is rerun.
- The first hand valve is opened and then closed to allow tritium from the container to enter the void space between the two valves.
- The second hand valve is opened and then closed to allow the trapped tritium to expand into the port volume.
- The outside of the port connection area can be sniffed with a tritium monitor. The containment system tritium monitor may be observed for an increase in tritium concentration to detect a tritium leak from the port connection into the containment volume.
- If no leak is detected, then the two series valves may be opened, and the reconnection is complete.

6.3.1 Tritium Apparatus, Isolation Valves, and Purge Ports

A “purge port” is a capped, sealed port connected through a valve to a potentially tritium-contaminated volume. The purpose of a purge port is to provide a path, which can be used to remove tritium-contaminated gases from the isolation volume prior to making a line break at the component flanges to remove a component. If the tritium-contaminated gases are not removed from the isolation volume, they will be released into the containment system when the flange is unsealed. The released gases and outgassing from the isolation volume surfaces will contaminate the containment volume gases. Following removal and replacement of a component, the port is used to leak test the new component and flange seals prior to placing the component in service.

Figure 6-2 is an illustration of two purge ports installed to allow evacuation of the volume and leak testing of the flanges between two sets of valves, thus allowing isolation and removal of a tritium-contaminated component. Note that the purge ports are part of the permanently installed system, and are not part of the component.

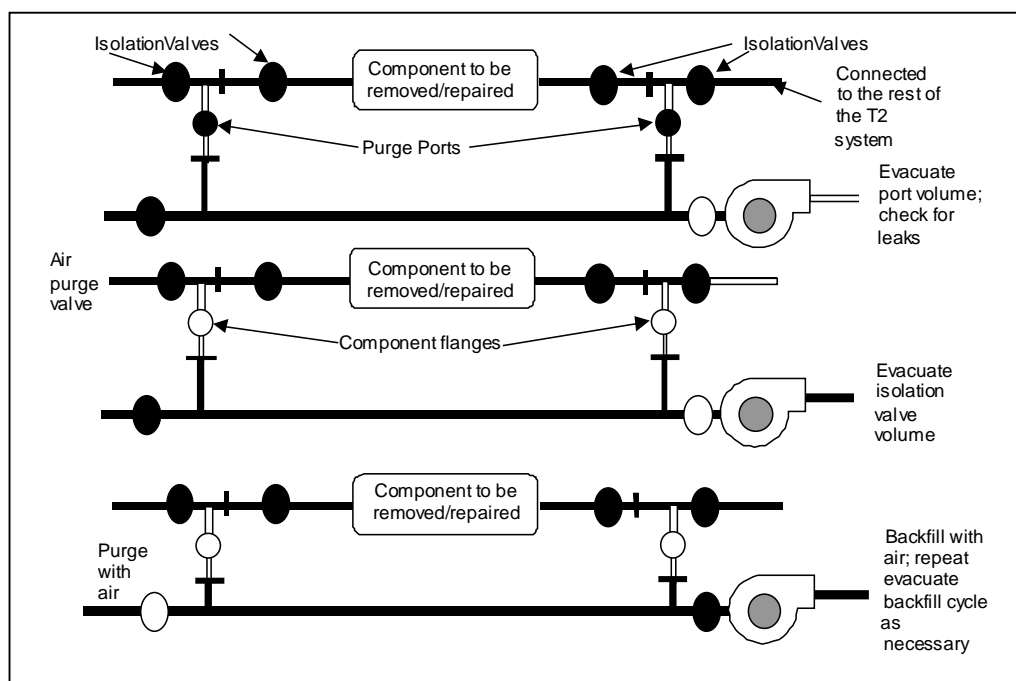

FIGURE 6-2. Purge ports and isolation valves

The component is isolated with two valves on each side of the component, and a purge port has been installed between each set of valves. The purge port allows evacuation of the volume between the two valves to remove the tritium-contaminated gases from the isolation volume prior to removal of the component.

In operation, the two sets of valves are closed to isolate the component from the rest of the tritium manifold. A vacuum pump is connected to the two purge ports. The purge port valves are opened and the gases trapped between the isolation valves are evacuated to remove the tritium-contaminated gases. In most applications, air is allowed to enter the purged volume, and the evacuation operation is repeated. Other gases, such as argon and nitrogen, may be used; however, air is usually more effective at decontaminating the surfaces. Ambient air entering the purged volume contains several thousand parts per million of normal water along with the nitrogen and oxygen. Some of the tritium and HTO on the internal surfaces of the purged volume exchange with the hydrogen and water in the ambient air and are pumped out during the purge cycle. This purge/backfill cycle is repeated 3 to 6 times to remove as much of the tritium as possible before disconnecting the component. Performance of three ambient air purge backfill cycles is typical, and, in practice, more than 6 purge backfill cycles has not proven to be beneficial.

After the component has been removed and replaced, the new component is leak tested through the purge port before the isolation valves are opened. The sequence of operations is as follows:

- The four component isolation valves are closed.
- The purge ports are uncapped and connected to a vacuum pumping system.
- The port volume is evacuated and leak checked.
- If no leaks are found, the purge port valves are opened, and the gases in the volume between the isolation valves are evacuated to a tritium-contaminated waste gas collection and removal system.
- The evacuation valve is closed, and air is allowed to enter the isolation volume through a valve mounted on the maintenance manifold.
- The air inlet valve is closed. The ambient air is allowed to sit in the isolation volume for a few minutes to allow the exchange of hydrogen and tritium to take place.
- The evacuation valve is opened, and the volume is again pumped out to the cleanup system.
- This evacuation and/or backfill sequence can be repeated several times.
- The component is disconnected at the maintenance flanges and removed. The new component is installed.
- To control outgassing from the removed component, blind flanges with installed purge ports may be installed over the open end of the removed component.
- The new flange connections are leak tested through the purge ports. If the new flange connections are not leak tight, they are repaired or replaced and retested.
- When the component and flanges are leak tight, the purge valves are closed, disconnected from the leak test system, and capped.
- The component isolation valves are opened, and the new component is placed in service.

As is always the case when dealing with process quantities of tritium, adherence to procedures is particularly important. If a large source (e.g., container) of tritium is connected via valving to the piping used in evacuating, an inadvertent valve operation could result in a significant loss. One such incident occurred at Mound, in which a valve was inadvertently opened, resulting in a loss of approximately 10 grams of tritium to the cleanup system via the evacuation header.

6.4 Receiving Tritium

Nuclear Material may be delivered to a receiving area, a receiving storage area, or directly to the tritium-handling facility. A brief description of the DOE regulatory requirement is as follows:

- The Receiving Area and/or Receiving Storage Area must be inside a posted “Controlled Area.”
- The Receiving Area and/or Receiving Storage Area must be inside a posted “Radioactive Materials Area (RMA).”
- The Receiving Area and/or Receiving Storage Area must be posted to reflect the radiological hazard that exists due to the quantity and types of nuclear material received and/or stored.
- The Receiving Area and/or Receiving Storage Area must be inside a “Controlled Area” and posted as a Controlled Area.
- Inside the Controlled Area is an area posted as a RMA.
- The boundary of the Controlled Area and the RMA can be the same boundary.

The area where the nuclear material is being kept while waiting to be transported from the Receiving Area must be posted as a Controlled Area and an RMA while the nuclear material is present. When the nuclear material is moved to a Storage Area, the signs can be removed. While in the Receiving Area and/or Storage Area, the material must remain in the certified shipping container. No nuclear material handling or unpacking can take place in this area.

As long as the material remains packaged in the approved container (includes certification), the quantities are not a facility issue during the receiving process. However, the total site quantities, including the packaged material, cannot exceed limits specified in the site’s EIS.

Site and facility management may have internal requirements and limits associated with the receipt and storage of nuclear materials. In general, as long as the material remains in the approved shipping package it can be received, stored, and transported per requirements.

The container should be radiologically surveyed to determine radiological posting needs and to ensure it is safe for storage. When the material is removed from the receiving area, the RMA, and Controlled Area, and radiological sign may be removed.

6.5 Storage of Packaged Nuclear Materials

The packaged nuclear materials may be transported to a storage area while awaiting transport to a tritium-handling operations area. While in the Storage Area the same rules apply as those in the Receiving Area.

- The Storage Area must be inside a posted “Controlled Area.”
- The Storage Area must be inside a posted “RMA.”
- The Storage Area must be posted to reflect the radiological hazard that exists due to the quantity and types of nuclear material stored.
- The nuclear material must remain packaged in the certified shipping containers.
- Periodic surveys must be performed and be sufficiently detailed to determine that surface contamination levels are not exceeded, airborne releases are not occurring, and packages are not leaking.

7.0 PACKAGING AND TRANSPORTATION

7.1 General Administrative Packaging and Transport Requirements

Transport of tritium in concentrations greater than 70 Bq/g (0.002 μ Ci/g) meets the definition of a Class 7 (Radioactive) Material under DOT regulations. As a hazardous material, tritium is subject to the DOT hazardous materials regulations (HMR) in 49 CFR Parts 106 through 180. These regulations specify the shipping paper, marking, labeling, placarding, and packaging requirements for hazardous material. The safety requirements for packaging are dependent on the type, form, and quantity of tritium, per DOE O 460.1A, "Packaging and Transportation Safety". Additional packaging and transportation regulations for radioactive material, established by the U.S. Nuclear Regulatory Commission (NRC), are found in 10 CFR 71.

Tritium may also meet the definition of other hazard classes in 49 CFR 173; e.g., tritium gas, in certain conditions, may meet the definition of a flammable gas. Tritium-contaminated hazardous waste will be subject to the requirements for hazardous waste shipments.

Organizational responsibility for the packaging and transport of hazardous materials such as tritium need to be clearly defined. Written procedures must be developed for the operations that package and ship tritium. DOT hazardous materials regulations (49 CFR 172.704) require initial and recurrent general awareness/familiarization, safety-related and function-specific training for hazardous materials workers.

There are also pre-transport requirements applicable to hazardous/mixed wastes that address packaging, labeling, marking, placarding, and accumulation time provisions which can be found in 40 CFR 262.30 – 34.

The guidance provided in this Handbook assumes that tritium is the only radioactive material in the packages. If another radionuclide is present, additional requirements may apply to the packaging and transport of the combination of radioactive materials.

7.2 Selection of Proper Packaging

The package types for radioactive material are limited quantity excepted package, low specific activity (LSA), surface contaminated object (SCO), Type A and Type B. The definitions of the package types are listed in order of increasing allowable radioactivity material limits.

- Limited Quantity Excepted Package: The requirements for a limited quantity package of tritium are as follows:
 - The radiation level at any point on the external surface of the package does not exceed 0.005 milliSievert (mSv)/hr (0.5 mrem/hr).
 - The amount of radioactive material is less than the limit in 49 CFR 173.425 (see Table 7-1).
 - The package meets the general design requirements for radioactive materials packaging from 49 CFR 173.410 (see Section 7.2.3).
 - The nonfixed (removable) contamination on the external surface of the package does not exceed the limits in 49 CFR 173.443 (0.41 Bq/cm² or 22 dpm/cm² for tritium).
 - The outside of the inner or outer packaging is marked "Radioactive."

The advantage to using the limited quantity excepted packaging is that it is excepted from specification packaging, marking, labeling, and, if not a hazardous substance or hazardous waste, it is also excepted from the shipping paper and certification requirements of the HMR.

- LSA is a quantity of Class 7 (radioactive) material with limited specific activity. Shielding materials surrounding the LSA material may not be considered in determining the estimated average specific activity of the package contents. The definition for LSA was recently revised into three groups: LSA-I, LSA-II, and LSA-III. Type A packages, which are discussed later, are limited to an A_2 quantity of radioactivity where the quantity A_2 is listed in the regulatory documentation for each individual radioactive material. The A_2 quantity for tritium is 40 TBq (1080 Ci) per Type A package. The LSA activity limits are based on the Type A package A_2 quantity limit. The definitions for these groups are provided below.
 - LSA-I is defined as contaminated earth, concrete, rubble, other debris, and activated material in which the radioactive material is essentially uniformly distributed and the average specific activity does not exceed $10^{-6}A_2/g$. For tritium, the maximum allowable specific activity for LSA-I is 4×10^{-5} TBq/g (0.001 Ci/g, 1 Ci/kg, or 2.2 lb/Ci).
 - LSA-II is defined as either water with tritium concentration up to 0.8 TBq/L (20.0 Ci/L) or material in which Class 7 (radioactive) material is essentially uniformly distributed and the average specific activity does not exceed $10^{-4}A_2/g$ for solids and gases and $10^{-5}A_2/g$ for liquids. For tritium-contaminated solids or gases, the maximum allowable specific activity is 0.004 TBq/g (0.1 Ci/g, 100 Ci/kg). The resulting limit for tritium-contaminated liquid (other than tritiated water) is 4×10^{-4} TBq/g (0.01 Ci/g).
 - LSA-III is defined as solids such as consolidated wastes or activated materials that meet the testing requirements of 49 CFR 173.468 (water leach test) and the following requirements:
 - The Class 7 (radioactive) material is essentially uniformly distributed throughout a solid or a collection of solid objects or essentially uniformly distributed in a solid compact binding agent (such as concrete, bitumen, or ceramic).
 - The Class 7 (radioactive) material is relatively insoluble, or is intrinsically contained in a relatively insoluble material, so that, even under loss of packaging, the loss of Class 7 (radioactive) material per package by leaching when placed in water for seven days would not exceed $0.1 A_2$. The resulting limit for tritium is 4 TBq (108 Ci).
 - The average specific activity of the solid does not exceed $2 \times 10^{-3}A_2/g$. The resulting limit for tritium is 0.08 TBq/g (2.16 Ci/g).

The advantage to using LSA instead of Type A packaging is that, for exclusive use shipments, bulk and strong, tight packaging can be used in some cases, if authorized. In addition, LSA packages are excepted from the marking and labeling requirements of 49 CFR 173 Subpart I.

- SCO is similar to LSA but is limited to a solid object that is not itself radioactive but has Class 7 (radioactive) material distributed on any of its surfaces. SCO is divided into two groups, SCO-I and SCO-II. The definitions are provided below.
 - SCO-I is defined as a solid object that meets all of the following requirements:
 - The nonfixed contamination on the accessible surface averaged over 300 cm^2 (or the area of the surface if less than 300 cm^2) does not exceed 4 Bq/cm^2 (10^{-4} Ci/cm^2) for beta emitters such as tritium.

- The fixed contamination on the accessible surface averaged over 300 cm² (or the area of the surface if less than 300 cm²) does not exceed 4 x 10⁴ Bq/cm² (1 •Ci/cm²) for beta emitters such as tritium.
 - The nonfixed plus the fixed contamination on the inaccessible surface averaged over 300 cm² (or the area of the surface if less than 300 cm²) does not exceed 4 x 10⁴ Bq/cm² (1 •Ci/cm²) for beta emitters such as tritium.
- SCO-II is defined as a solid object on which the limits for SCO-I are exceeded and meets all of the following requirements:
- The nonfixed contamination on the accessible surface averaged over 300 cm² (or the area of the surface if less than 300 cm²) does not exceed 400 Bq/cm² (10⁻² •Ci/cm²) for beta emitters such as tritium.
 - The fixed contamination on the accessible surface averaged over 300 cm² (or the area of the surface if less than 300 cm²) does not exceed 8 x 10⁵ Bq/cm² (20 •Ci/cm²) for beta emitters such as tritium.
 - The nonfixed plus the fixed contamination on the inaccessible surface averaged over 300 cm² (or the area of the surface if less than 300 cm²) does not exceed 8 x 10⁵ Bq/cm² (20 •Ci/cm²) for beta emitters such as tritium.
- Type A packages are limited to an A₂ quantity of radioactivity. The A₂ limit for tritium is 40 TBq (1080 Ci) per package. The physical form of the package contents must be within the envelope of the contents used during testing of the package. Type A packages are significantly less expensive and much easier to obtain than Type B packages.
 - Type B packages provide the highest level of safety features of all types of radioactive material packaging. The contents are limited by the requirements of the Certificate of Compliance (CoC) for the package. The CoC is issued by the agency that certifies that the package meets the Type B requirements.

7.2.1 Form and Quantity of Tritium

The form of the tritium affects the quantity of tritium that may be shipped in one package and the design and testing requirements for the packaging. Table 7-1 is a comparison of the allowable quantities of tritium in various package types.

7.2.2 Evaluation of Approved Packaging

Tritium-contaminated solid waste is typically packaged in DOT Type A, Specification 7A open head 55-gallon drums or Type A metal boxes. The maximum amount of tritium that may be shipped in a Type A package is 40 TBq (1080 curies).

Packages containing over 40 TBq of tritium must meet the Type B container requirements. These containers are few in number, and, compared to Type A packages, expensive to manufacture and use. If Type B packages are to be considered for shipments, the CoC should be reviewed carefully against the form and quantity of tritium to be shipped.

TABLE 7-1. Allowable quantities of tritium per 49 CFR 173

Form	Shipping Package Type	Maximum Quantity/ Specific Activity of Tritium per Package	Comments
Solid	Limited Quantity	0.04 TBq (1.08 Ci)	
	LSA-I	4×10^{-5} TBq/g (0.001 Ci/g)	
	LSA-II	0.004 TBq/g (0.1 Ci/g)	The conveyance limit* for combustible solids is 4000 TBq (1.08×10^5 Ci)
	LSA-III	0.08 TBq/g (2.16 Ci/g)	
	SCO-I	Limit based on surface contamination	The maximum nonfixed contamination on accessible surfaces is 4 Bq/cm^2 ($10^{-4} \bullet \text{Ci/cm}^2$). The maximum fixed contamination on accessible surfaces is $4 \times 10^4 \text{ Bq/cm}^2$ ($1 \bullet \text{Ci/cm}^2$). The total surface contamination on the inaccessible surfaces is limited to 10^4 Bq/cm^2 ($1 \bullet \text{Ci/cm}^2$). The conveyance limit* is 4000 TBq (1.08×10^5 Ci)
	SCO-II	Limit based on surface contamination	The maximum nonfixed contamination on accessible surfaces is 400 Bq/cm^2 ($10^{-2} \bullet \text{Ci/cm}^2$). The maximum fixed contamination on accessible surfaces is $8 \times 10^5 \text{ Bq/cm}^2$ ($20 \bullet \text{Ci/cm}^2$). The total surface contamination on the inaccessible surfaces is limited to $8 \times 10^5 \text{ Bq/cm}^2$ ($20 \bullet \text{Ci/cm}^2$). The conveyance limit* is 4000 TBq (1.08×10^5 Ci)
	Type A Type B	40 TBq (1080 Ci) Limited by Certificate of Compliance for the package	The Type B, UC-609 package is limited to 150 grams of tritium
Liquid	Limited Quantity (tritiated water)	37 TBq (1000 Ci) 3.7 TBq (100 Ci) 0.037 TBq (1 Ci)	<0.0037 TBq/L (0.1 Ci/L) 0.0037 to 0.037 TBq/L (0.1 to 1.0 Ci/L) >0.037 TBq/L (1.0 Ci/L)
	Limited Quantity (other liquids)	0.004 TBq (0.108 Ci)	
	LSA-II	4×10^{-4} TBq/g (0.01 Ci/g)	The conveyance limit* is 4000 TBq (1.08×10^5 Ci)
	Type A	40 TBq (1080 Ci)	
	Type B	Limited by Certificate of Compliance for the package	The Type B, UC-609 package is limited to 150 grams of tritium
	Gas	Limited Quantity	0.8 TBq (21.6 Ci)
LSA-II		0.004 TBq/g (0.1 Ci/g)	The conveyance limit* is 4000 TBq (1.08×10^5 Ci)
Type A		40 TBq (1080 Ci)	
Type B		Limited by Certificate of Compliance for the package	The Type B, UC-609 package is limited to 150 grams of tritium

*The conveyance limit is the limit per trailer if highway transportation is used.

The UC-609 and TRUPACT-II are the currently approved Type B containers for tritium and tritium-containing materials. The UC-609 is a drum type container with a limited volume containment

vessel. The containment vessel is authorized for containers of tritium gas, tritiated water, or tritium-containing solids and is limited to 150 grams of tritium. The TRUPACT-II is authorized for fourteen DOT Type A, Specification 7A 55-gallon drums or two Standard Waste Boxes. The authorized waste forms for the TRUPACT-II are solids or solidified liquids.

Tritium waste that meets the definition of LSA or SCO may be shipped domestically in a DOT Type A, Specification 7A packaging or a strong, tight package. A strong, tight package is defined as a package that prevents leakage of the radioactive content under normal conditions of transport. A strong, tight package may be used if the shipment is made for exclusive use and each package is limited to 40 TBq (1080 Ci) of tritium.

7.2.3 Minimum Requirements for Packaging

The design requirements for a radioactive materials package are located in 10 CFR 71.43 and 49 CFR 173.410. These requirements include the following:

- The smallest overall dimension may not be less than 10 centimeters (4 inches).
- The outside of the package must incorporate a feature, such as a seal, that is not readily breakable and that, while intact, would be evidence that the package had not been opened by unauthorized persons.
- A containment system securely closed by positive fastening devices that cannot be opened unintentionally or by a pressure that may arise within the package.
- Materials and construction that ensure that there will be no significant reaction between the package components, and contents, including possible reaction resulting from inleakage of water, to the maximum credible extent. Account must be taken of the behavior of materials under irradiation. (Irradiation of materials is not a significant consideration with tritium. However, chemical compatibility with hydrogen needs to be evaluated for shipments of gaseous tritium.)
- Any valves or devices, the failure of which would allow radioactive contents to escape, must be protected against unauthorized operation and, except for a pressure relief device, must be provided with an enclosure to retain any leakage.
- Design, construction, and preparation for shipment so that under the tests specified in 10 CFR 71.71 there would be no loss or dispersal of contents, no significant increase in the external surface radiation level, and no substantial reduction in the effectiveness of the packaging.
- No features that will allow continuous venting.
- The package can be easily handled and properly secured in or on a conveyance during transport.
- Each lifting attachment that is a part of the package must be designed with a minimum safety factor of five, based upon breaking strength, when used to lift the package in the intended manner, and it must be designed so that failure of any lifting attachment under excessive load would not impair the ability of the package to meet other requirements of 49 CFR Subpart I. Any other structural part of the package, which could be used to lift the package, must be capable of being rendered inoperable for lifting the package during transport or must be designed with strength equivalent to that required for lifting attachments.
- The external surfaces, as far as practicable, will be free from protruding features and will be easily decontaminated.
- The outer layer of packaging will avoid, as far as practicable, pockets or crevices where water might collect.
- Each feature that is added to the package will not reduce the safety of the package.

DOE-HDBK-1129-99

- The package will be capable of withstanding the effects of any acceleration, vibration, or vibration resonance that may arise under normal conditions of transport without any deterioration in the effectiveness of the closing devices on the various receptacles or in the integrity of the package as a whole and without releasing the nuts, bolts, or other securing devices even after repeated use.

For transport by air, the following requirements apply:

- The integrity of containment will not be impaired if the package is exposed to ambient temperatures ranging from -40°C (-40°F) to 55°C (131°F).
- Packages containing liquids will be capable of withstanding, without leakage, an internal pressure that produces a pressure differential of not less than 95 kPa (13.8 lb./square inch).

The surface temperature of packages is limited to 38°C (100°F) for nonexclusive shipments and 50°C (122°F) for exclusive shipments. This requirement should not be an issue with tritium shipments based on the low decay heat for tritium.

The requirements for Type A packages include the ability to withstand the following tests specified in 49 CFR 173.465:

- Water spray—simulation of 2 inches of rainfall per hour for at least one hour.
- Free drop—a drop of 1 to 4 feet, depending on the package mass, onto a hard surface.
- Stacking—compressive load of five times the package mass for a minimum of 24 hours.
- Penetration—this test is performed by dropping a 6 kilogram, 3.2 centimeter steel bar onto the weakest point of the package from a minimum height of one meter.

Packages designed for liquids and gases are required to pass a more rigorous free drop and penetration test than solids.

7.2.4 Onsite versus Offsite Shipments

Offsite shipments of hazardous materials or any shipment that meets the requirements of “transportation in commerce” must comply with the HMR. DOT provided a clarification of transportation in commerce in a 1991 letter to DOE. The following is excerpted from the letter:

“Transportation on (across or along) roads outside of Government properties generally is transportation in commerce. Transportation on government properties requires close analysis to determine whether it is in commerce. If a road is used by members of the general public (including dependents of Government employees) without their having to gain access through a controlled access point, transportation on (across or along) that road is in commerce. On the other hand, if access to a road is controlled at all times through the use of gates and guards, transportation on that road is not in commerce.

“One other means of preventing hazardous materials transportation on Government property from being in commerce is to temporarily block access to the section of the road being crossed or used for that transportation. The road would have to be blocked by persons having the legal authority to do so and public access to the involved section of road would have to be effectively precluded.”

Attachment 1 to DOE Order 460.2, "Departmental Materials Transportation and Packaging Management," requires that contractors shall comply with the HMR for on site materials transfers or comply with an approved site- or facility specific Transportation Safety Document that describes the methodology and compliance process to meet equivalent safety for any deviation from the Hazardous Materials Regulations.

7.3 Package Loading and Preparation for Shipment

7.3.1 Disassembly and Inspection of the Package

DOE Order 460.2 requires that DOE contractors inspect incoming hazardous materials shipments for damage or loss and evidence of leakage. Radioactive material shipments shall be inspected for external surface contamination and dose rate.

Preliminary determinations prior to first use of any packaging are required by 10 CFR 71.85. The determinations are as follows:

- Ascertain that there are no cracks, pinholes, uncontrolled voids, or other defects that could significantly reduce the effectiveness of the packaging.
- Where the maximum normal operating pressure will exceed 35 kPa (5 lb/in²) gauge, the package user shall test the containment system at an internal pressure at least 50 percent higher than the maximum normal operating pressure to verify the capability of that system to maintain its structural integrity at that pressure.

Prior to the first use of any radioactive materials packaging, 49 CFR 173.474 requires the offerer to determine the following:

- The packaging meets the quality of design and construction requirements as specified in 49 CFR Subpart I.
- The effectiveness of the shielding, containment, and, when required, the heat transfer characteristics of the package, are within the limits specified for the package design.

7.3.2 Package Loading and Assembly Operations

Sections 10 CFR 71.87 and 49 CFR 173.475 require routine determinations during the loading of a radioactive materials package. Before each shipment of any Class 7 (radioactive) material, the offerer must ensure, by examination or appropriate tests, the following:

- The packaging is proper for the contents to be shipped.
- The packaging is in unimpaired physical condition, except for superficial marks.
- Each closure device of the packaging, including any required gasket, is properly installed, secured, and free of defects.
- Each special instruction for filling, closing, and preparation of the packaging for shipment has been followed.
- Each closure, valve, or other opening of the containment system through which radioactive material might escape is properly closed and sealed.
- The internal pressure of the containment system will not exceed the design pressure during transportation.
- External radiation and contamination levels are within the allowable limits specified in 49 CFR 173 Subpart I.

- Any system for containing liquid is adequately sealed and has adequate space or other specified provision for expansion of the liquid.
- Any pressure relief device is operable and set in accordance with written procedures.
- Any structural part of the package that could be used to lift or tie down the package during transport is rendered inoperable for that purpose, unless it satisfies the design requirements of 10 CFR 71.45. (See Section 7.2.3.)
- Accessible package surface temperatures will not exceed the limits in 10 CFR 71.43 at any time during transportation. (See Section 7.2.3.)

7.3.3 Leak Testing

Leak testing is required for radioactive materials shipments in Type B packages to ensure that the tritium is contained within the package. The package must be leak-tight as defined by American National Standards Institute (ANSI) N14.5. Assembly verification and maintenance verification leak testing requirements will be noted in the CoC for the Type B package.

Packages that contain liquid in excess of the A₂ quantity for tritium (40 TBq or 1,080 Ci) and intended for air shipment must be tested to show that they will not leak under an ambient atmospheric pressure of not more than 25 kPa, absolute (3.6 psia). The test must be conducted to determine compliance with this requirement on the entire containment system or on any receptacle or vessel within the containment system.

7.3.4 Preparation for Shipment

For each shipment of more than 40TBq (1080 Ci) of radioactive material, DOE Order 460.2 requires the contractor to notify the shipment consignee of the dates of the shipment, the expected date of arrival, and any special loading or unloading instructions. Placarding for tritium shipments is required if the packages are labeled with Radioactive Yellow III labels or for exclusive use shipments. Marking, labeling, and shipping paper requirements from 49 CFR 172 need to be evaluated for each shipment of hazardous materials.

7.4 Documentation and Records

The 10 CFR 71.1 record may be the original or a reproduced copy. A microform may be used provided that authorized personnel authenticate the copy. The record may also be stored in electronic media with the capability for producing legible, accurate, and complete records during the required retention period. Each record must be legible throughout the retention period specified by regulation. Records such as letters, drawings, and specifications must include all pertinent information such as stamps, initials, and signatures. The licensee shall maintain adequate safeguards against tampering with and loss of records.

The requirements of 10 CFR 71.91 are as follows:

- Each licensee shall maintain for a period of three years after shipment a record of each shipment of licensed material not exempt under 10 CFR 71.10, showing where applicable:
 - Identification of the packaging by model number;
 - Verification that there are no significant defects in the packaging, as shipped;
 - Volume and identification of coolant;

DOE-HDBK-1129-99

- Type and quantity of licensed material in each package and the total quantity of each shipment;
 - Date of shipment;
 - For Type B packages, any special controls exercised;
 - Name and address of the transferee;
 - Address to which the shipment was made; and
 - Results of the determinations required by 10 CFR 71.87 and by the conditions of the package approval.
- The licensee shall make available to the Commission for inspection, upon reasonable notice, all records required by this part. Records are valid only if stamped, initialed, or signed and dated by authorized personnel or otherwise authenticated.
 - Each licensee shall maintain sufficient written records to furnish evidence of the quality of packaging. The records to be maintained include results of the determinations required by 10 CFR 71.85; design, fabrication, and assembly records; results of reviews, inspections, tests and audits; results monitoring work performance and materials analyses; and results of maintenance, modification, and repair activities. Inspection, test, and audit records must identify the inspector or data recorder, the type of observation, the results, the acceptability, and the action taken in connection with any deficiencies noted. The records must be retained for three years after the life of the packaging to which they apply.

The documents and records requirements of 10 CFR 830.120 state, "Documents shall be prepared, reviewed, approved, issued, used and revised to prescribe processes, specify requirements, or establish design. Records shall be specified, prepared, reviewed, approved and maintained."

7.4.1 Type A Package Documentation

Federal regulation 10 CFR 71 establishes documentation requirements for transportation. Several sections apply to Type A package documentation:

10 CFR 71.5 Transportation of Licensed Material

- Each licensee who transports licensed material outside of the confines of its plant or other place of use, or who delivers licensed material to a carrier for transport, shall comply with the applicable requirements of the regulations appropriate to the mode of transport of DOT in 49 CFR Parts 170 through 189.
 - The licensee should particularly note DOT regulations in the following areas:
 - Packaging - 49 CFR 173, Subparts A and B and paragraphs 173.401 through 173.478.
 - Marking and labeling - 49 CFR 172, Subpart D and paragraphs 172.400 through 172.407; 172.436 through 172.440.
 - Placarding - 49 CFR 172.500 through 172.519, 172.556 and Appendices B and C.
 - Monitoring - 49 CFR 172, Subpart C.
 - Accident reporting - 49 CFR 171.15 and 171.16.
 - Shipping papers - 49 CFR 172, Subpart C.
 - The licensee should also note DOT regulations pertaining to the following modes of transportation:

- Rail - 49 CFR 174, Subparts A-D and K.
- Air - 49 CFR 176, Subparts A-D and M.
- Vessel - 49 CFR 176, Subparts A-D and M.
- Public Highway - 49 CFR 177.

10 CFR 71 Subpart D - Application for Package Approval

- The application for package approval must include, for each proposed packaging design, the following information:
 - A package description as required by 10 CFR 71.33;
 - A package evaluation as required by 10 CFR 71.35; and
 - A quality assurance program description as required by 10 CFR 71.37.

Except as provided in 10 CFR 71.13, an application for modification of a package design, whether for modification of the packaging or authorized contents, must include sufficient information to demonstrate that the proposed design satisfies the package standards in effect at the time the application is filed.

10 CFR 71 Subpart E - Package Approval Standards

- Demonstration of compliance must be in accordance with 10 CFR 71.41.
- General standards for all packages are specified in 10 CFR 71.43.
- Lifting and tie-down standards for all packages are specified in 10 CFR 71.45.
- External radiation standards for all packages are specified in 10 CFR 71.47.

7.4.2 Type B User Documentation

In addition to Type A package requirements, Type B packages have documentation requirements defined in 10 CFR 71 and 49 CFR 173.

10 CFR 71.51 - Additional requirements for Type B packages

- A Type B package, in addition to satisfying the requirements of paragraphs 10 CFR 71.41 - 71.47 must be designed, constructed, and prepared for shipment so that under the tests specified in
 - Section 10 CFR 71.71 (Normal Conditions of Transport), there would be no loss or dispersal of radioactive contents, as demonstrated to a sensitivity of 10^{-6} A₂ per hour, no significant increase in external surface radiation levels, and no substantial reduction in the effectiveness of the packaging; and
 - Section 10 CFR 71.73 (Hypothetical Accident Conditions), there would be no escape of krypton-85 exceeding 10 A₂ in one week, no escape of other radioactive material exceeding a total amount A₂ in one week, and no external radiation dose rate exceeding 10 mSv/h (1 rem/h) at one meter (40 in) from the external surface of the package.
- Compliance with the permitted activity release limits of paragraph (a) of this section must not depend upon filters or upon a mechanical cooling system.

49 CFR 173.413 - Requirements for Type B packages.

- Each Type B(U), or Type B(M) package must be designed and constructed to meet the applicable requirements in 10 CFR 71.

49 CFR 173.403 - Definitions

- Type B(U) package means a Type B packaging that, together with its radioactive contents, for international shipments requires unilateral approval only of the package design and of any stowage provisions that may be necessary for heat dissipation.
- Type B(M) packaging means a Type B packaging, together with its radioactive contents, that for international shipments requires multilateral approval of the package design, and may require approval of the conditions of shipment. Type B(M) packages are those Type B package designs which have a maximum normal operating pressure of more than 700 kilopascals per square centimeter (100 psi gauge) or a relief device which would allow the release of Class 7 (radioactive) material to the environment under the hypothetical accident conditions specified in 10 CFR Part 71.

49 CFR 173.471 - Requirements for U.S. Nuclear Regulatory Commission (NRC)-approved packages.

- In addition to the applicable requirements of the NRC and parts 49 CFR 171 through 177, any shipper of a Type B, Type B(U), Type B(M), or fissile material package that has been approved by the USNRC in accordance with 10 CFR 71 shall also comply with the following requirements:
 - The shipper shall be registered with the NRC as a party to the approval, and shipment must be made in compliance with the terms of the approval;
 - The outside of each package shall be durably and legibly marked with the package identification marking indicated in the NRC approval;
 - Each shipping paper related to the shipment of the package shall bear the package identification marking indicated in the NRC approval;
 - Before the first export shipment of the package, the shipper shall obtain a U.S. Competent Authority Certificate for that package design, or, if one has already been issued, the shipper shall register with the U.S. Competent Authority as a user of the certificate. Upon registration as a user of the certificate, the shipper will be furnished with a copy of it. The shipper shall then submit a copy of the U.S. Competent Authority Certificate applying to that package design to the national competent authority of each country into or through which the package will be transported, unless a copy has already been furnished;
 - Each request for a U.S. Competent Authority Certificate as required by the IAEA regulations shall be submitted in writing to the address set forth in paragraph (e) of this section. The request shall be in duplicate and include copies of the applicable NRC approval and a reproducible drawing showing the make-up of the package. Each request is considered in the order in which it is received. To allow sufficient consideration by the Associate Administrator for Hazardous Materials Safety, requests should be received at least 45 days before the requested effective date;
 - Import and export shipments may be made in accordance with 49 CFR 171.12.

49 CFR 173.473 - Requirements for foreign-made packages.

- In addition to other applicable requirements of this subchapter, each shipper of a foreign-made Type B, Type B(U), Type B(M), or fissile material package for which a competent authority certificate is required by the IAEA "Regulations for the Safe Transport of Radioactive Materials, Safety Series No. 6" should also comply with the requirements in 49 CFR 173.473.

7.5 Quality Assurance/Control Requirements

7.5.1 DOT Quality Control Requirements

Quality control requirements for packaging and transportation are defined in 10 CFR 71 and 49 CFR 173.

10 CFR 71.37 Quality Assurance

- The applicant shall describe the quality assurance program (see subpart H of this part) for the design, fabrication, assembly, testing, maintenance, repair, modification, and use of the proposed package.
- The applicant shall identify any established codes and standards proposed for use in package design, fabrication, assembly, testing, maintenance, and use. In the absence of any codes and standards, the applicant shall describe the basis and rationale used to formulate the package quality assurance program.
- The applicant shall identify any specific provisions of the quality assurance program which are applicable to the particular package design under consideration, including a description of the leak testing procedures.

49 CFR 173.474 Quality control for construction of packaging

- Prior to the first use of any packaging for the shipment of radioactive material, the shipper shall determine that
 - The packaging meets the quality of design and construction requirements as specified in this subchapter; and
 - The effectiveness of the shielding, containment, and, when required, the heat transfer characteristics of the package, are within the limits specified for the package design.

49 CFR 173.475 Quality control requirements prior to each shipment of radioactive materials.

- Before each shipment of any radioactive materials package, the shipper shall ensure by examination or appropriate tests, that
 - The package is proper for the contents to be shipped;
 - The package is in unimpaired physical condition, except for superficial marks;
 - Each closure device of the packaging, including any required gasket, is properly installed, secured, and free of defects;
 - Each special instruction for filling, closing and preparation of the packaging for shipment has been followed;
 - Each closure, valve, or other opening of the containment system through which the radioactive content might escape is properly closed and sealed;

- Each packaging containing liquid in excess of an A₂ quantity and intended for air shipment has been tested to show that it will not leak under an ambient atmospheric pressure of not more than 0.25 atmosphere, absolute, (0.25 kilograms per square centimeter or 3.6 psia). The test must be conducted on the entire containment system, or on any receptacle or vessel within the containment system, to determine compliance with this requirement.
- The internal pressure of the containment system will not exceed the design pressure during transportation; and
- External radiation and contamination levels are within the allowable limits specified in this subchapter.

7.5.2 Quality Assurance Requirements for Type B Packages

Quality assurance requirements for the use and maintenance of Type B packages are defined in 49 CFR 173 and 10 CFR 71.

49 CFR 173.413 Requirements for Type B packages

- Each Type B(U) or Type B(M) package must be designed and constructed to meet the applicable requirements in 10 CFR 71.

10 CFR 71.0 Packaging and Transportation of Radioactive Material - Purpose and Scope

- This part establishes: (1) requirements for packaging, preparation for shipment, and transportation of licensed material; and (2) procedures for fissile material and for a quantity of other licensed material in excess of a Type A quantity.
- The packaging and transport of licensed material are also subject to other parts of this chapter (e.g. Parts 20, 21, 30, 39, 40, 70 and 73) and to the regulations of other agencies (e.g. the U.S. Department of Transportation and the U.S. Postal Service having jurisdiction over means of transport. The requirements of this part are in addition to and not in substitution for other requirements.

The regulations in this part apply to any certificate holder and to any licensee authorized by specific license issued by the Commission to receive, possess, use, or transfer licensed material if the licensee or certificate holder delivers that material to a common or contract carrier for transport or transports the material outside the confines of the licensee's or certificate holder's facility, plant, or other authorized place of use. No provision of this part authorizes possession of licensed material.

8.0 TRITIUM WASTE MANAGEMENT

The regulations governing waste are complex. It is important to understand the basic concept of "waste" and the difference between waste, low-level (radioactive) waste, sanitary land fill waste, reusable equipment, usable materials, and scrap. The following provides a guideline for defining waste.

- All materials, whether inside or outside a radiological or nuclear facility, which are of negligible or no economic value, considering the cost of recovery, are waste.

- Low-Level Waste (LLW) is any waste that has radioactive contamination values above the unrestricted release limit (DOE Order 5400.5).
- Sanitary Landfill Waste, which has no value and is below the unrestricted release limit, is waste and may be disposed of in a DOE Sanitary Landfill. Disposal of this waste at a Non-DOE Sanitary Landfill may be done after notifying the appropriate state agency of the DOE authorized limits for this activity.
- Reusable Equipment, such as computers, tools, electrical instruments, drill presses, etc., which can be used if released without restriction from the facility and has value, is not waste. If the equipment is contaminated above the unrestricted release limit and can be transferred and used at another radiological or nuclear facility, it is not waste.
- Usable Materials, such as nails, bolts, nuts, sheet rock, plywood, plastic sheet, barrels, decorative rock, sand, gravel, brick, unused chemicals, etc., which can be used if released without restriction from the facility and have value, are not waste. If the material is contaminated above the unrestricted release limit and can be transferred and used at another radiological or nuclear facility, it is not waste.
- Scrap, such as scrap non precious metal, scrap precious metals, scrap wood, scrap, chemicals, etc., which can be sold as scrap if released without restriction from the facility, has value, and is not waste.

8.1 Approved Limits for the Release of Contaminated Materials and Property Containing Residual Radioactive

For release and disposal, materials that exhibit radioactive surface contamination less than the values in the revised Figure IV-1 of DOE Order 5400.5 (which is planned to be specified in Table 1, "Surface Activity Guidelines," of 10 CFR 834), fall into three categories.

- Category 1 Disposal in a DOE or non-DOE Sanitary Landfill
- Category 2 Disposal and/or Treatment in a DOE or Non-DOE RCRA Treatment, Storage, and Disposal Facility
- Category 3 Transfer of Ownership (either by sale or other means) to Members of the Public

The Category 1 materials may be released/disposed of without further regard to residual radioactivity if they are at or below the values specified in the revised Figure IV-1 of DOE Order 5400.5 or the Table 2 values to be specified in 10 CFR 834. Site policies and procedures should clearly describe the use of these values and how other requirements of the Order (such as ALARA, survey measurement record keeping, and compliance with the specific requirements of the disposal facility) are met. Disposal at a Non-DOE Sanitary Landfill must meet the same requirements as waste disposed at a DOE Sanitary Landfill, and the appropriate state agency must be notified of the DOE-authorized limits for this activity.

Category 3 material must meet the same requirements as Category 1 material and the appropriate state agency and/or NRC Region must be notified of the DOE-authorized limits for this activity.

8.1.1 Release Limit Requirements for Surface-Contaminated Material

There are two DOE directives: Federal Rule 10 CFR 835, "Occupational Radiation Protection," and DOE Order 5400.5, which cover the control limits and methods of removable surface contamination measurement.

Appendix D of 10 CFR 835 specifies surface contamination value for use in determining whether a location needs to be posted as a contamination or high-contamination area (Subpart G), and if an item is considered to be contaminated and cannot be released from a contamination or high-contamination area to a controlled area (Subpart L). 10 CFR 835 does not permit unrestricted release of contaminated items. The surface contamination value for removable tritium is 10,000 dpm/100 cm. In addition, Footnote 6 of Appendix D provides a requirement to consider the migration of tritium from the interior of an item to the surface when applying the surface contamination value for tritium.

The second regulation concerns the release of materials per the requirements of DOE Order 5400.5. This document provides requirements for unrestricted release of contaminated objects. This requirement is described in the document "Response to Questions and Clarification of Requirements and Processes: DOE 5400.5, Section II.5 and Chapter IV Implementation (Requirements Relating to Residual Radioactive Materials)." [34] This document recommends the use of 10,000 dpm/100 cm² as an interim guideline for removable tritium. This limit is also specified in Table 1, "Surface Activity Guidelines." (See Appendix D.)

The committee drafting ANSI standard N13.12, "Surface and Volume Radioactivity Standards for Clearance," during a presentation at the 1998 annual meeting of the Health Physics Society, reported that the proposed screening level for unrestricted used items with residual levels of tritium on the surface was 600,000 dpm/100 cm, of which no more than 20% or 120,000 dpm/100 cm should be removable. This recommendation has not yet been approved for publication by ANSI.

Although not specifically addressed in the regulations, users should be cautioned that, in some cases, the initial, relatively clean concrete surface measurements did not accurately characterize the bulk tritium contents (see 4.6.2).

8.1.2 Removable Surface Contamination Measurement Process

The regulatory requirements are not specific as to how the removable surface contamination wipe is to be done or whether or not it is to be wet or dry. Footnote 4 of Appendix D to 10 CFR 835 states that a dry wipe may not be appropriate for tritium, but does not provide an explanation as to what may be appropriate. As a result, it would seem that either a wet or dry wipe can be used and still meet the requirements of 10 CFR 835. The requirements stated in "Response to Questions and Clarification of Requirements and Processes" [34] include: "The measurement should be conducted by a standard smear measurement but using a wet swipe or piece of Styrofoam," although in Table 1 of this document, a dry wipe (i.e., a dry filter or soft absorbent paper) is specified. The "should" included in this sentence and the use of Styrofoam would seem to allow for the use of either dry or wet wipes.

The use of a wet or dry wipe to determine removable surface contamination levels is noteworthy due to possible differences in measured levels between the two techniques.

The measurement of removable surface contamination has not been standardized by the technical disciplines, and, as a result, it is difficult to compare readings between facilities. Reasons for variations between facilities may be due to the following:

- Instrumentation: The instruments used for counting wipes are of different manufacturers and models providing varying accuracy and precision. The methodologies used are not standardized or cross-checked against each other to determine if results are similar.
- Units: The measurement units used at the different sites are either dpm/100 cm² or dpm/cm² with the former being the more common. Comparing results from one facility to another requires careful checking to make sure that the dpm values discussed are for the same area of surface.
- Wipe Material: The wipe materials most commonly used are dry filter paper, Styrofoam, and Q-Tips. There is no standardization of materials across facilities.
- Wipe Preparation: Dry wipes and wet wipes are used at the facilities. The wet wipes are prepared by soaking the Q-Tip or the filter paper in water, counting solution, or other liquids.
- Wipe Technique: The technique used to determine the area wiped and pressure applied when using the different materials varies from site to site.
- Dry versus wet wipes: Recent comparative tests performed at the LLNL Tritium Facility show that there are differences in the results obtained between a dry and a wet wipe of the same surface. In some cases, the dry wipe resulted in measured values higher than those measured by a wet wipe, while in other cases the wet wipe was higher. These tests, using de-ionized water as the wetting agent, indicate that the difference between a dry or wet wipe is a function of the type of surface and the level of contamination. Generally, the levels measured by wet and dry wipes of the same surface are within a factor of 3.

Good practices in this area for consideration include:

- When the surface of the object is less than 100 cm², the activity per 100 cm² should be calculated based on the area wiped, and the entire object should be wiped.
- Records should be kept in units of dpm/100cm².
- Either dry or wet wipes can be used to satisfy regulatory requirements. The requirements do not identify a wetting agent, nor do they specifically require a wet wipe. Some facilities use wet wipes in the belief that this is a more conservative approach. In fact, depending on the specific surface conditions, either method may produce somewhat higher measured values. Given the high intrinsic variability of the wet swipe process and the fact that the dry method is less complex and can be standardized and performed more consistently, the dry process is the preferred method of this Handbook.
- The methods used to measure removable surface contamination are not presently standardized and are not the same at all facilities. The following discussion describes a Generic Wipe Survey Technique that could be used at any DOE facility.

- The amount of removable material should be determined by wiping an area of 100 cm² on the object using dry filter paper or a dry Q-Tip, applying moderate pressure, and measuring the amount of radioactive material on the dry wipe.
 - Dry Filter Paper: The wiping technique, using dry filter paper, should consist of wiping a total path length of 16 inches using a single 16-inch lazy-S path or multiple shorter lazy-S paths that total 16 inches (tests show an average wipe width of 1 inch for dry filter paper).
 - Q-Tip: The wiping techniques, using a dry Q-Tip, should consist of wiping a total path length of 80 lineal inches of Q-Tip path (tests show an average wipe width of 0.2 inches for a Q-Tip).
- The Generic Wipe Survey Technique can be used for most applications; however, items with hidden surfaces or inaccessible areas require special consideration. For items that possess inaccessible areas that do not normally contact tritium, use of the Generic Wipe Survey Technique on the accessible surface area is sufficient in that these areas become contaminated only as a result of contamination on the surface area. However, for inaccessible areas such as pipes, tubes, drains, ductwork, valves, pumps, vessels, or transducers that potentially contact tritium, a two-step process is recommended:
 - First Wipe Survey: The accessible surfaces of the item should be wipe-surveyed using the Generic Wipe Survey Technique.
 - Second Wipe Survey: A second wipe survey should be made of the entry points into the item inaccessible areas (such as fittings, valve throats, ends of tubes, cracks, doors, and louvers). The second wipe survey should be made with a Q-Tip inserted as far as reasonably possible into the openings of the items. The total area of wipe should be estimated and the results corrected to dpm per 100 cm².

8.1.3 Environmental Discharge Requirements

DOE Order 5400.5 makes use of a “best available technology” selection process to reduce effluent discharges; however, this process is not applicable to tritium. DOE Order 5400.5 relies on the philosophy of as low as reasonably achievable (ALARA) in tritium operations to reduce effluent levels. The restriction on liquid surface discharge is that the concentration be maintained less than the DCG value of 2.0E-3 μCi/ml. The NRC release limit for 10 CFR 20, is 1.0E-3 μCi/ml.

For airborne effluents, the annual discharge to the air (as stated in 40 CFR 61, National Emission Standards for Hazardous Air Pollutants) for all radionuclides on site must be such that the offsite boundary dose is less than 10 mrem. Therefore, stacking and evaporation are methods that could be considered if this contribution and all others result in a dose under 10 mrem. Agreements with local regulators, however, may preclude or significantly reduce the release values allowed by these regulations, as could ALARA concerns.

All discharges to the environment that may contain tritiated wastes should be provided with monitoring systems. Future designs will likely incorporate real-time attributes to announce when the discharge concentration exceeds the specified limits. Soil column discharge is highly discouraged.

8.1.4 Tritium-Contaminated Waste Water

The generation of tritium-contaminated water is an inherent part of any tritium-handling operation. Any water used in a facility that handles tritium has the potential of being contaminated. To ensure that wastewater exiting such a facility does not exceed regulatory limits, the facility must measure the tritium content of the wastewater generated, and control its disposal.

8.1.4.a Tritium-Contaminated Waste Water Generation

The wastewater from a tritium facility falls into three categories:

- **Sinks and Floor Drains:** The least contaminated water is that water that runs into the facility sinks and floor drains. Unless water use is controlled, the volume of this water is typically in the tens of thousands of gallons per year. This water can generally be released to the sanitary sewer after the tritium content is measured to ensure that it is within regulatory limits.
- **Wash and Decontamination Water:** In a tritium handling area, contaminated wastewater is generated by routine activities such as mopping floors and decontamination of tools. Unless water use is controlled, the volume of water generated by these activities is typically in the hundreds to thousands of gallons per year. The tritium content of water from these activities is low, but is above background and is easily measured. Control and disposal of this low-level tritium-contaminated water is not industry standardized and, at present, is a function of the individual facility.
- **Tritium Removal System Waste Water:** Usually, the water collected by a facility Tritium Removal System will be the highest tritium concentration water collected at the facility. The volume of water generated by the tritium removal system is typically in the tens to hundreds of liters per year.

There are several potential methods for collection of the removal system wastewater. If possible, the system should be designed to collect water directly on a removable molecular sieve trap in less than 1,000 Ci quantities per trap. These traps can be disposed of as solid, low-level radioactive waste without further tritium handling if they are taken out of service (e.g., the date based on operational estimates of loading) prior to reaching 1080 Ci. The molecular sieve trap can be valved-off, certified to contain no pressure exceeding 1.5 atmospheres absolute at 20°C* and no free liquids, and can be disconnected from the apparatus and placed directly into a DOT 7A package for shipment to the disposal site.

Type B quantities (> 1080 curies/trap) may also be disposed of following this same technique except for overpacking the package in a Type B container for shipment to the disposal site. Due to

* DOE Order 5820.2A, from which the 1.5 atmospheres requirement is taken, has been replaced by DOE O 435.1, but in the revised Order the 1.5 atmosphere requirement only applies to initial gaseous forms ("Low-level waste in a gaseous form must be packaged such that the pressure does not exceed 1.5 atmospheres absolute at 20°C.") However, another requirement from DOE O 435.1 states, "When waste is packaged, vents or other measures should be provided if the potential exists for pressurizing containers or generating flammable or explosive concentrations of gases within the waste package." Interpretive guidance obtained from the Office of Planning and Analysis (EM-35), part of the Office of Waste Management (EM-30), indicates that tritium containers need not be vented if it can be demonstrated that no hazard exists from the non-vented tritium container.

radiolysis of the water, consideration must be given to the increase of hydrogen and oxygen pressure in the shipping package. Additionally, the pressure buildup in the container, due to decay of the tritium and radiolysis, has the potential to increase the pressure in the container above 1.5 atmospheres absolute.

The details of the packaging, stabilization of the waste item in the package, hydrogen generation in the package, and pressure buildup, and possible backfill of the void space with clay, should be explored with DOE waste site personnel before the first shipment is required. The DOE waste site criteria are subject to interpretation, and packaging details need to be discussed with DOE waste site personnel to make sure that the package meets their interpretation of the criteria.

8.1.4.b Tritium-Contaminated Waste Water Disposal

8.1.4.b(1) Solidification on Clay

Tritiated wastewater can be solidified on clay or Stergo superabsorbent (discussed in Section 8.1.4.b(2)), and disposed of as solid, low-level (radioactive) waste.

- Type A Quantities (< 1,080 curies)

The waste site should be asked to approve solidification of Type A quantities of tritium in the form of water solidified directly on clay in DOT 7A, 55-gallon drums. Following the waste site guidance, which typically requires that 100 percent more clay be used to solidify the water than required, the following packaging method should meet the criteria.

Clay will hold from 60 to 70 percent water by volume without any free liquid. The actual quantity that can be held is dependent upon the type of clay. Superfine[®] clay will hold 73 percent water by volume without any free liquid. Floroco[®] clay will hold approximately 65 percent by volume. Based upon this, a DOT 7A, 55-gallon drum filled with Superfine[®] clay will hold approximately 40 gallons of water. Following the typical guidance, which requires that 100 percent more adsorbent be used than required, a 55-gallon drum could be used to solidify 20 gallons of water.

Other methods and techniques of wastewater solidification are available such as clay-filled primary containers overpacked inside Type A containers, etc. Mixtures of cement, clay, and other materials have been used with success. Unfortunately, most of the more complex solidification methods require the use of some type of aggressive mixing method, such as barrel mixers, which results in spreadable contamination problems and the resulting increased personnel exposures.

- Type B Quantities (> 1,080 curies)

Type B quantities of tritium in the form of water may also be solidified and packaged at the generation site in Type A containers for the purpose of storage at the waste site. However, Type B quantity waste, packaged in Type A containers, must be placed in a Type B shipping package during transport and shipping to the waste site.

The Trupact II shipping package is approved for shipment of solidified, tritium-contaminated water.

8.1.4.b(2) Solidification on Polymers

PPPL has been performing studies of solidification in various polymers. PPPL ships tritium to Hanford for burial. Three polymers are approved for absorption of radioactive liquids for land burial at the Hanford site. In order for these polymers to absorb the liquids, and, therefore, exhibit the properties of a solid, they must be used in accordance with EPA test method 9096, "Liquid Release Test," so that they pass a pressure test of 20 psi (Hanford burial requirement). These polymers can provide significant advantages over "clay-based" absorbents in that they do not require mixing, and that they exhibit less than 1% expansion by volume.

PPPL's ER/WM Division has performed independent evaluations and testing of these polymers to verify the ratios and absorption capability. The testing has been performed by Kiber Environmental Services, Inc. of Norcross, Georgia. To date, one of the polymers has passed the 20 psi test using a modified test plan to account for the small particle size. Stergo has passed the 20 psi test at a ratio of 20:1 water:polymer. Also, two of the polymers have passed the test at a pressure of 50 psi (the normal test pressure), using ratios of 10:1. The two polymers are Stergo (Corpex Technologies) and SP-400 (Waterworks).

Users may want to perform their own additional independent testing to determine the correct ratio(s) for their product (if different from the aforementioned) and/or for their specific liquid characteristics. The PPPL testing was performed on tap water with a neutral pH.

8.1.4.b(3) Evaporation to the Environment

It is possible but expensive to solidify several thousand gallons of water containing only tens of curies of tritium. When properly permitted by State and Federal regulations, tritiated wastewater can be evaporated to the environment. An example of an evaporator, which was permitted by EPA, is the evaporator used at the now closed TRL facility at SNL. This tritium-contaminated wastewater evaporator was permitted to evaporate up to 100 Ci/yr to the environment. Over several years this system evaporated tens of thousands of gallons of extremely low-level tritium-contaminated water.

Evaporation may not be a reasonable or feasible method of wastewater disposal at every site; however, it was the preferred disposal option at Three Mile Island. Over 2.2 million gallons of tritiated water were collected for storage and treatment at the TMI site after the 1979 accident. This waste water, with tritium concentrations ranging from $1.6E-1 \mu\text{Ci/mL}$ to $2.4E-2 \mu\text{Ci/mL}$, resulted from many sources including the primary coolant, spent fuel pool, submerged demineralized system, and the EPICOR I and II ion-exchange processing systems. Lesser sources included wastewater from the decontamination of systems and components including steam generators and flushing of auxiliary systems. The principal constituents of this processed water were boric acid and tritium. The water was accumulated in large Process Water Storage Tanks (~ 600K gallons) and processed through a vacuum evaporator system. The majority of the tritiated water was released to the environment. The boric acid and residual radioactive contamination was concentrated into a powder form and disposed of at a LLW disposal facility in Barnwell, SC. In the past, these low-level concentrations of tritiated water were diluted to meet the 10 CFR 20 Appendix B limit of $< 1.0E-3 \mu\text{Ci/mL}$ and released. However, in this case, the estimated 1,000 Ci of tritiated water was released to the environment by evaporation. Refer to Figure 2-3 for comparison of the TMI accident-generated tritiated water concentrations with those found throughout the tritium complex.

8.1.4.b(4) Release to the Sanitary Sewer

Very-low-level tritium-contaminated water, which is generated by hand washing, showering, and normal facility water use, may be stored and analyzed to see that it meets state and Federal release criteria. If the water meets the regulations, it may be released to the local sanitary sewer. The NRC release limit for tritium as defined in 10 CFR 20 Appendix B, Table 3, for release to sanitary sewers is $1.0E-2 \mu\text{Ci/mL}$. This release limit is based on the monthly average (total quantity of tritium divided by the average monthly volume of water released to the sanitary sewer). If more than one radionuclide is released, the sum of the fractions rule applies. Also Draft 10 CFR 834 specifies less than a 5 Ci annual tritium release to sanitary sewers.

Regulations regarding the packaging for disposal and disposal of tritium-contaminated water are complex. The available choices for disposal are dependent on the tritium content of the water and the equipment available. Facility planning must include provisions for disposal of tritium-contaminated water at all levels of contamination down to a level that may be released to the local sanitary sewer system.

8.2 Waste Characterization

The purpose of hazardous waste characterization is to determine the applicability of the RCRA hazardous waste management requirements and to demonstrate compliance with these requirements (in accordance with 40 CFR Parts 261 through 268). Radioactive waste characterization must satisfy requirements in DOE Order 5820.2A. Mixed waste characterization must satisfy both. Waste characterization is the process used to determine the physical, chemical, and radiological properties of the LLW. As a general rule, if a hazardous waste component is reasonably expected to be present in a radioactive waste stream, it is advisable to manage the waste as mixed waste until the waste is characterized by chemical analysis or process knowledge to document that the waste contains no hazardous wastes as identified in 40 CFR 261.

Waste characterization is the process of identifying, assessing, and documenting the physical, chemical, and radiological properties of process wastes and wastes generated from cleanup and removal activities. The waste profile created during characterization is the foundation for waste segregation, management, and certification operations. Characterization programs must be developed to address waste certification requirements dictated by the waste management, disposal, or treatment option selected for each waste stream, in addition to the applicable regulatory requirements. The primary characterization determinations to be considered for tritium-contaminated waste are the low-level and hazardous waste determinations.

Defining process waste streams is one of the most overlooked aspects of waste characterization. Many generators believe characterization involves the assessment of inventory containers. Effective waste management must begin at the point of waste generation. The generator must first identify all of the waste-generating processes. Information such as process inputs, sub processes, equipment, and chemical use must be reviewed to generate an adequate profile for each waste stream.

Documenting the waste stream assessments is also an important part of the characterization process. It is critical that the personnel generating waste be provided with the information required to properly manage waste generated in their area. Additionally, an auditable record must be created that allows for review of the characterization process and determinations. Waste-generating processes must be reviewed periodically to identify changes that could result in the

addition of new streams or changes to existing streams. In addition, the regulations must be monitored to address promulgated and proposed changes that affect current or future characterization programs.

The Resource Conservation and Recovery Act (RCRA), an amendment to the Solid Waste Disposal Act, was enacted in 1976 to address the management of municipal and industrial wastes. RCRA includes a number of subtitles. Subtitle C of RCRA directs the management of hazardous waste. This subtitle imposes administrative provisions to ensure accountability for hazardous waste management, as well as substantive requirements designed to protect human health and the environment from the effects of improper management of hazardous waste. Under the RCRA implementing regulations, hazardous waste is defined as any solid waste exhibiting one or more of the characteristics of hazardous waste -- ignitability, corrosivity, reactivity, and metal or organic compound toxicity [40 CFR 261.20 - .24]; or is included on one of three lists of hazardous wastes [40 CFR 261.30 - .33]. These lists include hazardous wastes generated by nonspecific (F-listed wastes) and specific sources (K-listed wastes), in addition to commercial chemical products (P- and U-listed wastes). RCRA was amended significantly in 1984 by the Hazardous and Solid Waste Amendments (HSWA), which expanded the scope and requirements of RCRA. Among other things, HSWA required EPA to evaluate all listed and characteristic hazardous wastes, and to develop requirements (i.e., treatment standards) that must be achieved prior to land disposal of these wastes. The implementing regulations for accomplishing this statutory requirement are established within the Land Disposal Restrictions (LDR) program [40 CFR 268].

In conjunction with the hazardous waste and LDR-related waste determinations, additional physical and chemical information may be required depending on the treatment or disposal options being considered. These parameters may include, but are not limited to, the assessment of the waste for free liquids, headspace gases, chelating agents, anions/cations, PCBs, particulate, explosives, pyrophorics, and waste matrix composition.

8.2.1 Waste Knowledge

Waste knowledge or acceptable knowledge refers to information used to support waste characterization activities. In recent regulatory preambles and guidance, EPA uses the terms "waste knowledge" or "acceptable knowledge" in place of the term "process knowledge." The terms "waste knowledge" or "acceptable knowledge" are broader terms that include process knowledge, waste analysis data obtained from generators, and existing records of analysis, or a combination of this information supplemented with chemical analysis. Process knowledge is the common terminology for the RCRA regulatory language "applying knowledge of the hazard characteristic of the waste in light of the materials or the processes used." [40 CFR 262.11(c)(2)] EPA has defined process knowledge to include detailed information on the wastes obtained from existing published or documented waste analysis data or studies conducted on hazardous wastes generated by similar processes [see Joint NRC/EPA Guidance on Testing Requirements for Mixed Radioactive and Hazardous Waste, November 20, 1997 (62 FR 62079); and Waste Analysis at Facilities that Generate, Treat, Store, and Dispose of Hazardous Wastes: A Guidance Manual, OSWER 9938.4-03, April 1994]. Process knowledge includes any documentation that describes or verifies a facility's history, mission, and operations, in addition to waste stream-specific information used to define generating process, matrix, contaminants, and physical properties. Waste-generating facilities should maintain and utilize waste knowledge to characterize waste streams (i.e., in lieu of sampling and analyzing the waste), whenever possible, to avoid unnecessary exposures to radioactivity and eliminate needless or redundant waste testing. This requires the generator to maintain auditable records that document the composition of the waste, including waste matrix and contaminants.

The documentation should be constructed in such a way that independent review would result in consistent characterization conclusions. The collection, review, management, and dissemination of the information should be standardized and documented to ensure data integrity and that the information is defensible during future assessments.

The use of waste knowledge to characterize wastes may be applicable in a number of situations, including:

- Waste stream is difficult to sample because of the physical form.
- Sampling analysis would result in unacceptable risks of radiation exposure.
- Waste is too heterogeneous in composition.
- Waste sampling and analysis is not feasible or necessary.
- Waste stream results from well-documented specific processes, such as with standard laboratory operations.

8.2.2 Tritium Disposition Options

Tritium exists in various concentrations and forms throughout the complex. The tritium contained in waste streams could be stored, released to the environment (i.e., in compliance with applicable regulatory limits or permitted levels), or recovered for reuse. This section provides an overview of a process to help make an informed decision on tritium disposition.

The diagram depicted on Figure 8-1 provides a simplified flow path for ultimate disposition of tritiated material. The first fork is associated with the production source of the tritium. As discussed in Section 3.1.3, the RCRA regulations include an exclusion from the hazardous waste management requirements for source, special nuclear and byproduct material as defined by the AEA [40 CFR 261.4(a)(4)]. Reactor-produced tritium wastes meet this definition of “byproduct” material, and, as such, are excluded from the RCRA requirements applicable to solid waste and hazardous waste. Additionally, EPA has applied a regulatory policy in certain cases [Ref. 13-17] by which residuals, derived from the management of RCRA exempt or excluded waste, retain the exemption or exclusion (even if they subsequently exhibit hazardous characteristics). These considerations provide the basis for not including a hazardous waste determination step, relative to assessing the tritium itself, in the reactor-produced tritium fork presented in Figure 8-1.

Accelerator-produced tritium waste does not qualify for the RCRA source, special nuclear, and byproduct material exclusion. As such, any accelerator-produced tritium waste stream that exhibits one or more of the characteristics of hazardous waste (e.g., ignitability, corrosivity) would be subject to the RCRA hazardous waste provisions. For this reason, the accelerator-produced tritium fork in Figure 8-1 includes a determination of whether the material (i.e., the accelerator-produced tritium waste itself) is hazardous. The authors believe that it is unlikely that forms of tritiated materials in container configurations, used in the DOE complex, would exhibit any of the four characteristics of hazardous waste. This pathway, while unlikely to exist, is still possible (e.g., compressed tritium gas in a container configuration satisfies the characteristic of ignitability) and is illustrated in Figure 8-1.

Both the accelerator and reactor forks include a mixed waste determination. Specifically, this determination step considers whether the tritiated material also contains a RCRA hazardous waste component (i.e., in addition to the tritium/radioactive component). If a reactor-produced or accelerator-produced tritium waste stream also contains a hazardous waste component, the waste

stream would need to be managed as a radioactive mixed waste in accordance with the AEA and RCRA. The determination that a mixed waste exists will result in the more stringent disposition option depicted. Note that even though naturally-occurring and accelerator-produced radioactive materials do not constitute a source, special nuclear or byproduct material, all DOE waste containing naturally-occurring and accelerator-produced radioactive materials mixed with a hazardous component must be managed as hazardous waste under RCRA [pursuant to Order DOE 5820.2A]. The disposition options for non-hazardous, non-mixed tritium from both the accelerator and reactor sources is similar with the biggest difference resulting from the storage requirements for RCRA solid material. These disposition options are a function of the form (solid, liquid, or gas).

8.2.3 Economic Discard Limit for Tritiated Water

EPA uses the economic discard limit (EDL) to evaluate whether a hazardous material or residue should be classified as a waste. If it has sufficiently high economic value, the material should be considered for recovery and reuse. The intent is not to allow facility operations (both at Government Owned and Commercially Owned) to define material as not being waste and thereby not be required to meet the current federal statutes on permitting of hazardous waste material for treatment, storage, and disposal (TSD). In a simplistic form, the EDL is the threshold value in determining when a materials economic value (\$/unit weight or volume) exceeds the associated cost for the materials treatment, storage, and disposal. If the economic value, based on current market value or replacement value, is determined to be of greater value than the cost of TSD, the material can be considered non-waste. The governing statutes and requirements for non-waste are less extensive, and the disposition times are less severe.

There have been increasing discussions and studies of the feasibility of recovering the current oxide inventory (~200 grams) and continuing additions (~100 grams/year) in the DOE complex [35-36]. Even though the reports referenced originated at LANL, there are conflicting burial costs. For example, one states that LANL burial costs are on the order of \$1,000-\$3,000 per Ci and the other stating that the LANL costs possess “negligible local burial costs” and “interim storage incurs no significant space or other charges;” therefore, a much higher value of \$1,250 per Ci from Mound (Mound personnel contacted believe that this value is far too high for Mound costs) was used instead for illustrative purpose.

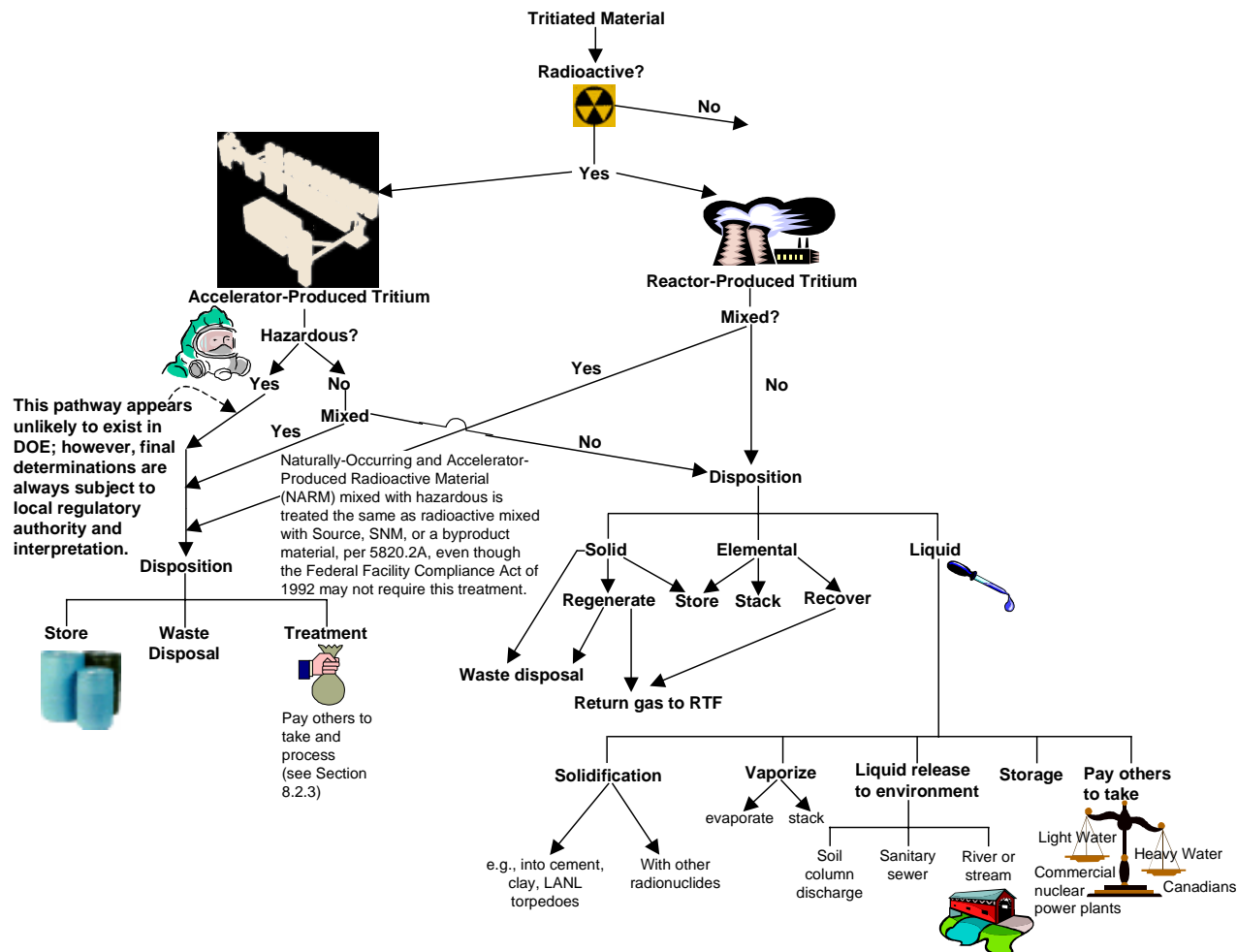

FIGURE 8-1. Ultimate disposition of tritiated material

The reports agree with the fact that burial costs are a function of volume, not concentration. However, the costs associated with Canadian detritiation services, which are an alternative to discard via burial, are a function of concentration. The mode of transportation and the number of packages per shipment are dependent upon concentration, thereby affecting costs. There are issues associated with paying for foreign disposal of hazardous wastes; however, these issues do not exist if the foreign (e.g., Canadian) services consist of detritification and return of the other constituents to the sender or to a U.S. waste processor.

Both reports referenced assign a relatively high value for the recovered tritium based on the cost to produce tritium in a new production source or the current market price. Although the current market price established by the Canadians is \$3.30 per Ci, it is irrelevant to the value of the recovered tritium. The Canadian price is arbitrary, and is based on selling only about 100 g/yr, with its supply of over 2,500 g/yr. For DOE to obtain customers to buy its tritium, it would have to drop the price substantially, and there is nothing to prevent the Canadians from further undercutting these lower prices. Likewise, the average cost of tritium in the new production source is irrelevant. Although the average cost to produce a Ci of tritium in DOE's new production source will be substantially higher than it was in the past, it is the marginal cost that is germane. The marginal cost to produce another 100 g/yr given the existence of a new production source is a small fraction of the average cost with both options (APT and CLWR). [37-38] Although an

accurate estimation of these costs cannot be made until after the new tritium source comes on line, the Canadian marginal cost for their tritium facility is estimated to be about \$0.25 per Ci. [39] It appears that the value of the recovered tritium (i.e., from waste streams; high Ci content process streams are more economical) is overstated, and that recovery options, even the most cost-effective such as the PMR, cannot be justified on economics alone. Any recovery argument should also have an environmental component or a different valuation philosophy for tritium. One such valuation model proposed by Mike Rogers of Mound is based on the opportunity costs of delaying the construction of the new production source. If the quantity of recovered tritium could delay the construction of the new production source, there is a savings to the Treasury of the time value of money. If government accounting practices are cognizant of such benefits, a quantified basis can be estimated to ascertain economic viability for recovery system construction (these cash outflows offset, to a small extent, the cash inflow savings). This valuation technology for tritium could only be used up to the time that a new production source comes onstream. Thereafter, a comparison of marginal costs of the recovery system and new production source could be made to decide on continuing with recovery operations.

In the absence of a Department-wide policy on tritium recovery, DOE sites with tritium oxide and tritiated water inventories should consider their EDLs based on the site-specific conditions and needs. The implication of the preceding discussion is that once tritium goes into the oxide form, it is difficult to justify on an economic basis alone using any recovery method. The fact that economic recovery of tritium from oxide form is not easily justified should be an important factor in designing tritium facilities.

8.3 Waste Packaging

DOE, DOT and NRC requirements for radioactive waste packaging are presented in Chapter 7.

Barriers, in addition to the outer packaging, should be considered to inhibit tritium migration from waste packages. The only significant difference associated with packaging of waste for shipment versus packaging of any other quantity of nuclear material for shipment is that Type B quantities of waste may be packaged in Type A containers at the waste generation site and shipped to the waste site overpacked in Type B containers such as the Trupact II. During shipment, the waste package must meet the current DOE and DOT regulations for shipment of the form and quantity of radioactive material; i.e., Limited Quantity, Type A Quantity, Type B Quantity. After receipt at the waste disposal site, the type A package containing the Type B quantity of low-level (radioactive) waste is removed from the Type B package. The Type B package is then returned to the shipper for reuse, and the Type A package containing the Type B quantity of tritium is stored at the waste disposal site along with the other low-level waste.

The waste acceptance requirements are a little different at each waste disposal site. The following is a list of things to be considered before waste is packaged.

- Free Liquids: Waste should contain as little free liquid as reasonably achievable, but under no conditions shall the free liquid volume exceed 0.5 percent by volume of the external container.
- Absorbent: If absorbent material is used to solidify liquid in the waste, then the quantity of absorbent material added to the waste must be sufficient to absorb a minimum of twice the volume of the liquid.
- Particulate: Waste in particulate form should be immobilized, and, if immobilization is impractical, other acceptable waste packaging shall be used, such as overpacking: drum

containing particulate enclosed in another drum; and wooden or steel box with particulate enclosed in a 6-mil sealed plastic liner inside the box.

- Gases: Pressure in the waste box shall not exceed 1.5 atmospheres absolute at 20°C. Compressed gases as defined by 49 CFR 173.300 are generally not accepted for disposal unless the valve mechanism has been removed or it is obvious that the container has been punctured.
- Containers, Vessels, Manifolds: Containers, vessels, and manifolds that have been exposed to tritium and should remain sealed, must be certified to contain no pressure greater than 1.5 atmospheres* absolute prior to packaging as waste.
- Stabilization: Where practical, waste should be treated to provide a more structurally and chemically stable waste form.
- Etiologic Agents: LLW containing pathogens, infectious wastes, or other etiologic agents as defined in 49 CFR 173.386 are generally not accepted.
- Chelating Agents: Chelating or complexing agents at concentrations greater than 1 percent by weight of the waste form are generally not accepted.
- Polychlorinated Biphenyls: Polychlorinated Biphenyls contaminated LLW is generally not accepted unless the Polychlorinated Biphenyls concentration is less than 50 ppm
- Explosives and Pyrophorics: Material in a form that may explode spontaneously or combust if the container is breached is generally not accepted for disposal.

8.4 Waste Shipping

The shipping requirements for Class 7 (radioactive) material can be found in Section 6.1. If the tritium waste is mixed with RCRA constituents, a hazardous waste manifest and Land Disposal Restriction notification is required for offsite shipments. See Section 7.1 for RCRA pre-transport requirements associated with mixed waste. In addition, any containers less than 110 gallons in capacity must be marked as hazardous waste in accordance with 40 CFR 262.32.

During shipment, the waste package must meet the current DOE and DOT regulations for shipment of the form and quantity of radioactive material; i.e. Limited Quantity, Type A Quantity, and Type B Quantity.

* DOE Order 5820.2A, from which the 1.5 atmospheres requirement is taken, has been superceded by DOE O 435.1, but in the revised Order the 1.5 atmosphere requirement only applies to initial gaseous forms ("Low-level waste in a gaseous form must be packaged such that the pressure does not exceed 1.5 atmospheres absolute at 20°C.") Another requirement from DOE O 435.1 states, "When waste is packaged, vents or other measures should be provided if the potential exists for pressurizing containers or generating flammable or explosive concentrations of gases within the waste package."

This page is intentionally blank.

APPENDIX A: USEFUL NUMERICAL VALUES

A.1 General Data

- 1 becquerel (Bq) = 1 disintegration/second = 2.7×10^{-11} Ci
- 1 Ci = 3.7×10^{10} disintegrations/second = 3.7×10^{10} Bq = 37 GBq
- Avogadro's Number = 6.023×10^{23} molecules/mole
- STP conditions: 760 Torr, and 0°C (1 atm and 273K)
- 1 mole of ideal gas at STP = 22.414 L at 0° C, and approximately 24.2 L/mole at room temperature
- 1 Sievert (Sv) = 8.38 roentgens = 100 rem

A.2 General Tritium Data

- Tritium decays to ^3He + beta + neutrino
- Half-life of tritium (Scientific purposes) = 12.323 ± 0.004 years (4500.88 ± 1.46 days)
- Half-life of tritium (Accountability purposes) = 12.33 ± 0.06 years (DOE M 474.1-2, Figure IV-2)
- Tritium decay factor = 0.99984601/day
- Maximum beta energy of decay (E max.) = 18.6 keV
- Mean beta energy of decay (E mean) = 5.69 keV
- Volume of 1 Ci of tritium at STP = 0.386 mL
- Tritium gas = 9619 Ci/g
- T₂ gas contains 58023 Ci/mole
- 2.589 Ci/cm³ of T₂ at STP
- Diameter of a tritium atom (approximate) = 1.1 Angstroms
- Dissociation energy, T₂ to 2T = 4.59 eV
- Ionization energy, T to T⁺ + e⁻ = 13.55 eV
- Atomic weight = 3.01605
- Gram molecular weight of tritium = 6.0321 g
- Grams tritium/liter at STP = 0.269122 g/L
- Liters/gram of tritium at STP = 3.71579 L/g
- Boiling point of tritium at 1 atmosphere = 25.0 K
- T₂ gas, at 1 atmosphere pressure and 25°C = 2.372 Ci/cm³
- Tritiated water, T₂O = 3200 Ci/cm³

A.3 Regulatory Quantities

- Type B Quantity = > 1080 Ci
- Type A Quantity = > 0.108 to <1080 Ci depending on form
- Limited Quantity = < 21.6 Ci of tritium in gaseous form
< 1.08 Ci of tritium in solid form
< 1 Ci of tritium at a concentration of > 1 Ci/L liquid
< 100 Ci at a concentration of > 0.1 to < 1 Ci/L liquid
< 1000 Ci at a concentration of < 0.1 Ci/L liquid
- A2 Quantity = 40 TBq (1080 Ci)
- Limited Quantity Excepted Package Requirement for tritium
 - Radiation level < 0.005 mSv/hr (0.5 mrem/hr)
 - Quantity of radioactive material < limit in 49 CFR 173.425

DOE-HDBK-1129-99

- Package meets general design requirements for radioactive material packaging from 49 CFR 173.410
- Nonfixed/removable contamination on the external surface of the package is < limit in 49 CFR 173.443 (0.41 Bq of tritium/cm² or 22 disintegrations/min (dpm)/cm² for tritium)
- Outside of inner or outer packaging is marked “Radioactive”
- Low Specific Activity (LSA) A quantity of Class 7 (radioactive) material with limited specific activity
 - LSA-I
 - Earth, concrete, rubble or other debris = 4×10^5 TBq of tritium/g (0.001 Ci of tritium/g, 1 Ci of tritium/kg or 2.2 lb/Ci of tritium)
 - LSA-II
 - Tritium-Contaminated Water up to: 0.8 TBq of tritium/L (20.0 Ci/L)
 - Solids and Gases up to 0.004 TBq of tritium/g (0.1 Ci/g, 100 Ci/kg)
 - Liquids 4×10^4 TBq of tritium/g (0.01 Ci/g, 10 Ci/kg)
 - LSA-III
 - Solids, consolidated wastes, or activated material that meet 49 CFR 173.468 water leach test; and
 - Uniformly distributed in a collection of solid objects or uniformly distributed in solid compact binding agent; i.e., concrete, bitumen, ceramic, etc.
 - Relatively insoluble or intrinsically contained in relatively insoluble material such that, under loss of packaging and placed in water for seven days, would not exceed 4 TBq of tritium (108 Ci of tritium)
 - The average specific activity of the solid does not exceed 0.08 TBq of tritium/g (2.16 Ci/g)
- SCO (Surface Contaminated Object) Non-radioactive solid objects with Class 7 (radioactive) materials distributed on the surfaces
 - SCO-I
 - Nonfixed contamination on accessible surface averaged over 300 cm² is < 4 Bq of tritium/cm² (10^4 μCi/cm²)
 - Fixed contamination on the accessible surface averaged over 300 cm² is < 4×10^4 Bq of tritium/cm² (1 μCi/cm²)
 - Nonfixed plus fixed contamination on the inaccessible surface averaged over 300 cm² is < 8×10^5 Bq of tritium/cm² (20 μCi/cm²)
 - SCO-II
 - Solid object on which limit for SCO-I is exceeded and meets the following:
 - Nonfixed contamination of accessible surface averaged over 300 cm² is < 400 Bq of tritium/cm² (10^{-2} μCi/cm²).
 - Fixed contamination of accessible surface averaged over 300 cm² is < 8×10^5 Bq of tritium/cm² (20 μCi/cm²).
 - Nonfixed plus fixed contamination of accessible surface averaged over 300 cm² is < 8×10^5 Bq of tritium/cm² (20 μCi/cm²).
- Type A Packages limited to 40 TBq of tritium (< 1080 Ci) per package
- Type B Packages for quantities > 40 TBq of tritium (> 1080 Ci) per package
- Graded Safeguards Program
 - Category III: Weapons or test components, containing reportable quantities > 50 g T₂ with isotopic fraction T₂ > 20 percent
 - Category IV: All other reportable quantities

- Facility Categories
 - Hazard Category 1: Category A reactors and facilities designated by PSO.
 - Hazard Category 2: > 30 g of tritium
 - Hazard Category 3: > 1.6 but < 30 g of tritium
 - Radiological Facility: < 1.6 g of tritium

A.3 Tritium Dose and Exposure Data

- Biological half-life = 8 to 12 days (oxide); biological half-life of tritides is currently being researched
- Derived Air Concentration (DAC)
 - DAC for HTO = $21.6 \mu\text{Ci}/\text{m}^3 = 2 \times 10^{-5} \mu\text{Ci}/\text{mL} = 8 \times 10^5 \text{Bq}/\text{m}^3$
 - DAC for HT = $540,000 \mu\text{Ci}/\text{m}^3 = 5 \times 10^{-1} \mu\text{Ci}/\text{mL} = 2 \times 10^{10} \text{Bq}/\text{m}^3$
 No DACs currently exist for tritides; efforts are underway to develop these
- Dose Conversion Factor (DCF)
 - DCF = 0.063 mrem/ μCi (inhalation)
 - DCF = 0.095 mrem/ μCi (inhalation plus 50 percent allowance for skin absorption)
- Annual Limit of Intake (ALI)
 - ALI for HTO = 80,000 μCi
 - An initial exposure equilibrium urine count of 1 $\mu\text{Ci}/\text{L}$ equates to approximately a 3-mrem dose.
 - A urine count of 50 $\mu\text{Ci}/\text{L}$ for a year equates to approximately a 5,000-mrem dose.
 - Breathing 21.6 $\mu\text{Ci}/\text{m}^3$ HTO in air for 8 hours/day, 50 week/year will result in a dose of approximately 5,000 mrem.
 - Tritiated water is approximately 25,000 times more hazardous than tritium gas because of rapid uptake mechanisms.
- Tritium Beta Particles
 - Range in Air = 4.5 to 6 mm
 - Range in Water = 0.0005 cm
 - Range in Tissue = 0.0007 cm
 - Radiation, 1 mCi in man (70 kg) = 0.0044 rem/day
 - Maximum Penetration = 0.6 mg/cm^3

A.4 Tritium Container Data

- WSRC Hydride Transport Vessel (HTV)
 - Reusable container for transporting up to 18 grams of tritium
 - Shipped in UC-609
 - Dual port, flow through capable
 - One female, one male port, Cajon® SS-4-VCR
 - Tritium stored as uranium tritide
 - Contains 493 g depleted uranium
 - Stoichiometry Maximum 1:2.9
 - Weight 9.3 lb
 - Height 9.995 in
 - Diameter 4.6 in
 - Volume 690 cm^3
 - Maximum normal operating temperature = 450°C
 - Pressure Limit at Maximum normal operating temperature = 2.9 psia
 - Tritium vapor pressure as a function of temperature at U:T = 1:2.9

- Dissociation Equations
 - $\text{Log } P_{\text{atm}} = -4038.2/T + 6.074, P_{\text{atm}} = 10^{-4038.2/T + 6.074}$
 - $\text{Log } P_{\text{psia}} = -4038.2/T + 7.2413, P_{\text{psia}} = 10^{-4038.2/T + 7.2413}$
- WSRC Product Vessel (PV)
 - Reusable container for transporting 10 g of tritium in liquid form
 - Shipped in UC-609
 - Volume 21 L
 - Maximum pressure 1,200 torr
 - Height 30.5 in
 - Diameter 9.875 in
 - Weight 44 lb
 - Single valve, Nupro® SS-4-HS-TW
 - Male Nut, Cajon® SS-4-VCR-4
 - Female Cap Cajon® SS-4-VCR-CP

A.5 Other Data

- Calorimeter Factor
 - 3.0657 +/- 0.009 g of tritium per Watt
 - 0.3240 +/- 0.0009 Watts/g of tritium
- ANSI N14.5-87 Leakage Test
 - $< 1 \times 10^{-7} \text{ cm}^3/\text{s } ^4\text{He}$

APPENDIX B: DEFINITIONS

Airborne radioactivity area – Any area where the measured concentration of airborne radioactivity, above natural background, exceeds or is likely to exceed 10 percent of the derived air concentration (DAC) values listed in Appendix A or Appendix C of this part (10 CFR 835). (DOE 10 CFR 835)

As low as reasonably achievable (ALARA) – A phrase (acronym) used to describe an approach to radiation protection to control or manage exposures (both individual and collective to the work force and the general public) and releases of radioactive material to the environment as low as social, technical, economic, practical, and public policy considerations permit. (DOE 5400.5)

Below regulatory concern – A definable amount of low-level waste that can be deregulated with minimal risk to the public. (DOE 5820.2A)

Best available technology for radioactive effluent control (BATREC) – The preferred effluent treatment technology, selected after taking into account factors related to technology, economics, public policy, and other parameters. As used in this part, the BATREC is not a specific level of treatment, but is the conclusion of a selection process in which several alternative effluent treatment technologies are evaluated. It has evolved from the BAT concept described in DOE 5400.5. This process, however, is not applied to tritium. (Draft DOE 834)

Buffer zone – The smallest region beyond the disposal unit that is required as controlled space for monitoring and for taking mitigative measures, as may be required. (DOE 5820.2A)

Byproduct material – (1) any radioactive material (except special nuclear material) yielded in or made radioactive by exposure to the radiation incident to the process of producing or utilizing special nuclear material, and (2) the tailings or wastes produced by the extraction or concentration of uranium or thorium from any ore processed primarily for its source material content. (Atomic Energy Act of 1954, 42 USC 2011)

Certified waste – Waste that has been confirmed to comply with disposal site waste acceptance criteria (e.g., the Waste Isolation Pilot Plant-Waste Acceptance Criteria for transuranic waste, the DOE/NVO-325 criteria) under an approved certification program. (DOE 5820.2A)

Confinement system

1. Any equipment, structure, or system, which limits the release and/or dispersion of a hazardous/radioactive material within a facility. Examples are fume hoods, air locks, ventilation systems, and may include containment and recovery systems. Confinement systems may consist of multiple techniques and barriers depending upon the quantity of tritium involved and the consequences of an uncontrolled release. (U.S. DOE Tritium Focus Group)
2. A collection of barriers that can satisfy a specified leak criterion contingent upon operation of its ancillary (active) system. An example of a confinement system is a glovebox and its associated cleanup system. (DOE-HDBK-1129-99)
3. The assembly of components of the packaging intended to retain the radioactive material during transport. (10 CFR Part 71)

4. An area having structures or systems from which releases of hazardous materials are controlled. Primary confinement systems are process enclosures (gloveboxes, conveyors, transfer boxes, and other spaces normally containing hazardous materials). Secondary confinement areas surround one or more primary confinement systems (operating area compartments). (DOE O 435.1)

Containment system

1. Any equipment, structure, or systems that serve as an integral and essentially leak tight barrier against the uncontrolled release of hazardous/radioactive material to the environment and other areas within the facility. Examples include process piping, sealed containers, tanks, gloveboxes, and any other closed loop system, which holds the material for possible recovery of tritium. (U.S. DOE Tritium Focus Group)
2. A collection of passive barriers that can satisfy a specified leak criterion without operation of any ancillary equipment. An example of a containment system is a series of piping and vessels enclosing tritium gas operations. (DOE-HDBK-1129-99)
3. A structurally closed barrier and its associated systems (including ventilation) between areas containing hazardous materials and the environment or other areas in the nuclear facility that are normally expected to have levels of hazardous materials lower than allowable concentration limits. A containment barrier is designed to remain closed and intact during all design basis accidents. (DOE O 435.1)

Derived Air Concentration (DAC) – For the radionuclides listed in Appendix A of 10 CFR 835, the airborne concentration that equals the Annual Limit of Intake (ALI) divided by the volume of air breathed by an average worker for a working year of 2,000 hours (assuming a breathing volume of 2400 m³). (DOE 10 CFR 835)

Derived Concentration Guide (DCG) – The concentration of a radio nuclide in air or water that, under conditions of continuous exposure for one year by one exposure mode (i.e., ingestion of water, submersion in air, or inhalation), would result in an effective dose equivalent of 100 mrem (1 mSv). DCGs do not consider decay products when the parent radionuclide is the cause of the exposure. (DOE 5400.5)

DOE/DOT Type A, approved shipping package – For the purpose of this text, these are packages that can be used for the transport of Type A quantities of radioactive materials. The two typical packages used for solids are metal 55-gallon drums with full removable lids and metal boxes 4 feet wide by 4 feet high and 7 feet long with removable lids. DOT 7A packages may be fabricated in almost any size to fit special needs like packaging of gloveboxes.

Facility segmentation – The concept of independent facility segments should be applied where facility features preclude bringing material together or causing harmful interaction from a common severe phenomenon. Therefore, the standard permits the concept of facility segmentation provided the hazardous material in one segment could not interact with hazardous materials in other segments. For example, independence of HVAC and piping must exist in order to demonstrate independence for facility segmentation purposes. This independence must be demonstrated and places the “burden of proof” on the analyst. Additionally, material contained in DOT Type B shipping containers (with or without overpack) may also be excluded from summation of a facility’s radioactive inventory if the Certificates of Compliance are kept current and the materials stored are authorized by the Certificate. However, Type B containers without overpack should have heat protection provided by the facility’s fire suppression system. (DOE-STD-1027-92, Rev. 1)

Free liquids – Liquids that readily separate from the solid portion of a waste under ambient temperature and pressure. (DOE 5820.2A)

Hazard Category 1 – A facility in which the hazard analysis shows the potential for significant off-site consequences. Category A reactors and facilities designated by PSO. Regardless of the quantity of tritium, a facility that handles only tritium is not a Hazard Category 1 facility unless it is designated so by the PSO. (DOE-STD-1027-92, Rev. 1)

Hazard Category 2 – A facility in which the hazard analysis shows the potential for significant on-site consequences. Facilities with the potential for nuclear criticality events or with sufficient quantities of hazardous material and energy, which would require on-site emergency planning activities. The threshold tritium inventory for a tritium facility to be designated as a Hazard Category 2 facility is 30 grams or 300,000 Ci. (DOE-STD-1027-92, Rev. 1)

Hazard Category 3 – A facility in which the hazard analysis shows the potential for only significant localized consequences. Facilities included are those with quantities of hazardous radioactive materials that meet or exceed values in Table A.1 of DOE-STD-1027-97. The threshold for tritium is specified as 1.6 grams or 16,000 Ci. (DOE-STD-1027-92, Rev. 1)

Hazardous materials – Those materials that are toxic, explosive, flammable, corrosive, or otherwise physically or biologically health-threatening. (DOE 5480.22)

Hazardous wastes – Those wastes that are designated hazardous by EPA regulations (40 CFR 261). (DOE 5820.2A)

Leak tight – A leakage rate that complies with ANSI N14.5-1987, which is less than or equal to 1×10^{-7} std cm³/sec. (standard cubic centimeters of gas per second) across a pressure gradient of 1.0 atmosphere. This rate is equivalent to the leakage of 4×10^{-12} moles of air or helium per second. (DOE-STD-3013-94)

Low-level waste – Waste that contains radioactivity and is not classified as high-level waste, transuranic waste, or spent nuclear fuel or 11e(2) byproduct material as defined by this Order (5820.2A). Test specimens of fissionable material irradiated for research and development only, and not for the production of power or plutonium, may be classified as low-level waste, provided the concentration of transuranic is less than 100 nCi/g. (DOE 5820.2A)

Mixed waste – Waste containing both radioactive and hazardous components as defined by the Atomic Energy Act and the Resource Conservation and Recovery Act, respectively. (DOE 5820.2A)

Nonreactor nuclear facility – Those activities or operations that involve radioactive and/or fissionable materials in such form and quantity that a nuclear hazard potentially exists to the employees or the general public. Included are activities or operations that

- Produce, process, or store radioactive liquid or solid waste, fissionable materials, or tritium;
- Conduct separations operations;
- Conduct irradiated materials inspection, fuel fabrication, decontamination, or recovery operations;
- Conduct fuel enrichment operations;

- Perform environmental remediation or waste management activities involving radioactive materials.

Incidental use and generating of radioactive materials in a facility operation (e.g., check and calibration sources, use of radioactive sources in research and experimental and analytical laboratory activities, electron microscopes, and X-ray machines) would not ordinarily require the facility to be included in this definition. Accelerators and reactors and their operations are not included. The application of any rule to a nonreactor nuclear facility should be applied using a graded approach. (DOE 5400.5)

Nuclear facility – Reactor and nonreactor nuclear facilities. DOE-STD-1027-92 defines inventory thresholds for DOE Order 5480.23 compliance and resulting applicability of nuclear facility requirements.

Primary containment – The first barrier to an uncontrolled release of hazardous/radioactive material to the environment and/or other areas in the facility. The barrier may/may not serve for containment of the radioactive material. (U.S. DOE Tritium Focus Group)

Primary containment vessel – The outermost sealed container intended for safe storage. When used as the outermost container for storage, it would also be used for shipping. (DOE-STD-3013-94)

Protective Action Guides (PAGs) – Projected numerical dose values established by EPA, DOE, or States for individuals in the population. These values may trigger protective actions that would reduce or avoid the projected dose.

Radioactive waste – Solid, liquid, or gaseous material that contains radionuclides regulated under the Atomic Energy Act of 1954, as amended, and of negligible economic value considering costs of recovery. (DOE 5820.2A)

Radiological area – Any area within a controlled area which must be posted as a “radiation area,” “high radiation area,” “very high radiation area,” “contamination area,” “high contamination area,” or “airborne radioactivity area” in accordance with 835.603 (10 CFR 835). (DOE 10 CFR 835)

Radiological facilities

1. Facilities that do not meet or exceed Category 3 threshold criteria specified in DOE STD-1027-92, Rev. 1, Table A.1, but still possess some amount of radioactive material may be considered Radiological Facilities. The Category 3 threshold quantity of tritium is 16,000 curies. Radiological Facilities are exempt from the requirements of DOE 5480.23, but are not exempt from other safety requirements. (DOE-STD-1027-92, Rev. 1)
2. Radiological facilities are those with an inventory of radiological materials below the levels as defined in DOE-STD-1027-92, (currently 16,000 curies) but above the reportable quantity value (currently 100 curies) listed in Appendix B to Table 302.4 (per 40 CFR 302). This lower limit of 100 curies is applicable to EM and DP facilities. (DOE-EM-STD-5502-94)

Receiving and/or shipping area – An area or two different areas that have been designated as radioactive materials Receiving and/or Shipping Areas and have been posted for the receipt and shipment of packaged radioactive materials.

Receiving and/or shipping, storage area – An area or two different areas that have been designated as the Receiving and/or shipping Area, Storage Area and have been posted for the storage of packaged incoming and outgoing shipments of radioactive materials.

Reference man – A hypothetical aggregation of human (male and female) physical and physiological characteristics arrived at by international consensus (ICRP Publication 23). These characteristics may be used by researchers and public health workers to standardize results of experiments and to relate biological insult from ionizing radiation to a common base. The “reference man” is assumed to inhale 8,400 cubic meters of air in a year and to ingest 730 liters of water in a year. (DOE 5400.5)

Release of property – As used in DOE Order 5400.5, it is the exercising of DOE’s authority to release property from its control after confirming that residual radioactive material (over which DOE has authority) on the property has been determined to meet the guidelines for residual radioactive material in Chapter IV of DOE Order 5400.5 or any other applicable radiological requirements. There may be instances in which DOE or other authority will impose restrictions on the management and/or use of the property if the residual radioactive material guidelines of Chapter IV of DOE Order 5400.5 are not met or if other applicable Federal, state, or local requirements cause the imposition of such restrictions. (DOE 5400.5)

Safety analysis – A documented process that:

- Provides systematic identification of hazards within a given DOE operation
- Describes and analyzes the adequacy of the measures taken to eliminate, control, or mitigate identified hazards
- Analyzes and evaluates potential accidents and their associated risks. (DOE Order 5400.5)

Safety analysis report (SAR) – A report that documents the adequacy of safety analysis for a nuclear facility to ensure that the facility can be constructed, operated, maintained, shut down, and decommissioned safely and in compliance with applicable laws and regulations. (DOE 5400.5)

Safety-class structures, systems, and components (safety-class SSCs). Systems, structures, or components including primary environmental monitors and portions of process systems, whose failure could adversely affect the environment, or safety and health of the public as identified by safety analyses (DOE 5480.30)

Safety-significant structures, systems, and components (safety-significant SSCs). Structures, systems, and components not designated as safety-class SSCs, but whose preventive or mitigative function is a major contributor to defense in depth (i.e., prevention of uncontrolled material releases) and/or worker safety as determined from hazard analysis.

Secondary containment – The second barrier to an uncontrolled release of hazardous or radioactive materials to the environment and/or other areas in the facility. The barrier may/may not serve for containment of the radioactive material. (U.S. DOE Tritium Focus Group)

Sievert – The dose delivered by a point source of 1 mg of radium, enclosed in a platinum container with walls 1/2 mm thick, to a sample at a distance of 1 cm over a period of 1 hour.

Soil column – A system that incorporates an *in-situ* volume of soil through which liquid waste percolates from ponds, cribs, seepage basins, or trenches with the primary purpose being to

retain suspended or dissolved radioactive material by absorption, ion exchange, or physical entrainment. Unless used specifically for radionuclide disposal, areas such as drain fields and natural ground surfaces or stream beds that may become contaminated as a result of incidental exposure are not soil columns. (Draft 10 CFR 834)

Source material – (1) uranium, thorium, or any other material which is determined by the commission pursuant to the provisions of section 61 (42 USC 2091) to be source material; or (2) ores containing one or more of the foregoing materials in such concentration as the Commission may by regulation determine from time to time. (Atomic Energy Act of 1954, 42 USC 2011)

Special nuclear material – (1) plutonium, uranium enriched in the isotope 233 or in the isotope 235, and any other material which the Commission, pursuant to the provisions of section 51 (42 USC 2017) determines to be special nuclear material, but does not include source material; or (2) any material artificially enriched by any of the foregoing, but does not include source material. (Atomic Energy Act of 1954, 42 USC 2011)

Stochastic effects – Biological effects, the probability, rather than the severity, of which is a function of the magnitude of the radiation dose without threshold; i.e., stochastic effects are random in nature. Nonstochastic effects are biological effects, the severity of which, in affected individuals, varies with the magnitude of the dose above a threshold value. (DOE 5400.5)

Storage – Retrievable retention of waste pending disposal. (DOE 5820.2A)

Technical safety requirements (TSRs) – Those requirements that define the conditions, safe boundaries, and the management or administrative controls necessary to ensure the safe operation of a nuclear facility and to reduce the potential risk to the public and facility workers from uncontrolled releases of radioactive materials or from radiation exposures due to inadvertent criticality. A TSR consists of safety limits, operating limits, surveillance requirements, administrative controls, use and application instructions, and the basis thereof. TSRs were formerly known as Operational Safety Requirements for nonreactor nuclear facilities and Technical Specifications for reactor facilities.

Tertiary containment – The third barrier to an uncontrolled release of hazardous or radioactive materials to the environment and/or other areas in the facility. The barrier may/may not serve for containment of the radioactive material. (U.S. DOE Tritium Focus Group)

Treatment – Any method, technique, or process designed to change the physical or chemical character of waste to render it less hazardous, safer to transport, store or dispose of, or reduced in volume. (DOE 5820.2A)

Waste container – A receptacle for waste, including any liner or shielding material that is intended to accompany the waste in disposal. (DOE 5820.2A)

Waste package – The waste, waste container, and any absorbent that are intended for disposal as a unit. In the case of surface contaminated, damaged, leaking, or breached waste packages, any overpack shall be considered the waste container, and the original container shall be considered part of the waste. (DOE 5820.2A)

APPENDIX C: ASSAY METHODS

There are a number of different assay methods used at the DOE tritium facilities. Most facilities need assay equipment capable of measuring tritium in gaseous, solid, and liquid form.

- **Gas Analysis:** For assay of gaseous tritium, most facilities use some form of mass spectrometer ranging from quadrupole to large sophisticated light isotope drift tube systems. Gas analysis equipment; especially gas analysis equipment which will measure the low molecular weight gases like H₂, HD, HT, D₂, DT and T₂ accurately; is very expensive and requires a high degree of expertise to operate. These systems can cost from fifty to several hundred thousand dollars.
- **Solid (Metal Tritide):** Tritium stored in solid form such as a metal tritide must either be decomposed to return it to the gas form for analysis, or the heat output of the solid caused by the decay of tritium can be measured in a constant heat flow calorimeter. In order to use calorimetry to measure the tritium quantity, it must be known that the item being assayed does not contain any other radioactive component and that no chemical reactions are taking place in the container. Constant heat flow calorimeters vary in chamber size from a few cubic centimeters up to a few liters, and the item to be assayed must be small enough to fit inside the calorimeter chamber. The constant heat flow assay process is the most accurate assay method available if the chamber size and item to be assayed are well matched.
- **Liquid (HTO, DTO, T₂O):** Tritium at high concentrations in liquid form is generally measured using calorimetry. Low concentrations of tritium in liquid form are generally measured by using a scintillation counter. A sample of the liquid is mixed in a scintillation cocktail, and the quantity of tritium in the sample is measured.

C.1 Measurement Accuracy and Safeguards and Security

DOE requires that tritium be accounted for to the hundredth of a gram. However, most of the equipment and the techniques used cannot accurately determine the tritium quantity to a hundredth of a gram once the quantity assayed exceeds about one half gram. This appears to be inconsistent with the DOE accountability requirements. Measurement accuracy better than that implied by the previous statement is certainly achieved but requires expensive, sophisticated equipment and world-class operators that are only justified by special process needs. Even the more sophisticated equipment does not measure the quantity of tritium accurately to a hundredth of a gram once the quantity exceeds about five grams. The assay technique to be used in an operation or facility should be frankly discussed with DOE safeguards and security to make sure that it will meet the DOE needs for the facility safeguards and security category and the activities performed in the facility.

C.2 Tritium Assay Analysis by PVT Mass Spectrometer

The most common method of assaying tritium in gaseous form, i.e., T₂, HT, and DT, mixed with other gases such as Ar, N₂, O₂, and ³He, is referred to as "PVT mass spec." The total number of moles of gas, n, in a container is calculated using the equation,

$$n = PV/zRT$$

where P = pressure in the container in torr

V = volume of the container in liters
 z = compressibility factor (See Table C.1)
 R = constant = 62.3631 (See below)
 T = temperature (K)

In the formula, the container volume (V) is determined ahead of time by measurement using a volume measuring system, or, if no other means is available, it may be calculated from the physical dimension of the container. The gas pressure (P) and temperature (T) are determined by measurement with available instruments at the time of the mass spec sampling. R is a constant, which is a function of the units of pressure and volume used in the equation and is equal to 62.3631 for pressure in torr and volume in liters.

The compressibility factor (z) is a function of gas type, pressure, and temperature and is either determined from a compressibility table for tritium or estimated using a standard equation such as

$$z_{(T2)} = 1 + [(P_{\text{(torr)}} \times 0.000832)/1000]$$

This equation is for a temperature of 295 K.

Most operating facilities have established methods for determining the compressibility factor. For those facilities that do not already have these methods established, Table C-1, Table of Tritium Compressibility Factors, may be helpful.

As an example, for a container with a volume of 22.414 L at a pressure of 760 torr and a temperature of 273.15 K (Standard Temperature and Pressure (STP) conditions) the number of moles is calculated as follows:

$$\begin{aligned}
 N &= PV/zRT \\
 &= (760 \times 22.414)/(1.000 \times 62.3631 \times 273.15) \\
 &= 1.0000 \text{ mole}
 \end{aligned}$$

Note: $z_{(T2)}$ at 273.15 K = 1.000.

The total moles of gas in the container at any time, t , is the sum of the moles of the individual gases present in the mixture at that time or in equation form:

$$PV/zRT = n_{(\text{Moles Total})} = n_{(T2)} + n_{(HT)} + n_{(DT)} + n_{(CT4)} + n_{(qTw)} + n_{(He-3)} + n_{(N2)} + n_{(O2)} + n_{(Ar)} + n_{(\text{etc.})}$$

The $n_{(qTw)}$ represents a generic tritium-containing component. The "q" in, $n_{(qTw)}$, represents any other element which may be present, and the "w" represents the number of tritium atoms in the molecule. The $n_{(\text{etc.})}$, represents any generic, non-radioactive, non-tritium component. From this equation, it follows that

$$PV/zRT = n_{(\text{Moles Total})} = n_{(\text{Total Moles of Tritium Containing Gases})} + n_{(\text{Total Moles of Non-tritium Gases})}$$

where

$$n_{(\text{Total Moles of Tritium Containing Gases})} = n_{(T2)} + n_{(HT)} + n_{(DT)} + n_{(CT4)} + n_{(qTw)} + \text{etc.}$$

and

$$n_{(\text{Total Moles of Non-Tritium Gases})} = n_{(He-3)} + n_{(N2)} + n_{(O2)} + n_{(Ar)} + n_{(\text{etc.})} + \text{etc.}$$

The number of moles of tritium in the container is the sum of the number of moles of tritium in each tritium component. The number of moles of tritium in each tritium component is equal to the number of moles of the component multiplied by the moles of tritium per mole of component.

DOE-HDBK-1129-99

The moles of tritium per mole of component is defined as the ratio of the number of tritium atoms in the component chemical formula to the number of tritium atoms in T₂, i.e., 2.

$$n_{(\text{Total Moles of Tritium})} = \frac{2n_{(\text{T}_2)}}{2} + \frac{1n_{(\text{HT})}}{2} + \frac{1n_{(\text{DT})}}{2} + \frac{4\text{CT}_4}{2} + \frac{w}{2} n_{(\text{qTw})} + \text{etc.}$$

TABLE C-1. Table of tritium compressibility factors at 295 K

$$Z_{(\text{T}_2)} = 1 + \{[(P_{\text{atm}} \times 760) \times 0.000832]/1000\}$$

P (atm)	z(T2)	P (atm)	z(T2)	P (atm)	z(T2)	P (atm)	z(T2)	P (atm)	z(T2)	P (atm)	z(T2)
0.0	1.0000	3.0	1.0019	6.0	1.0038	9.0	1.0057	12.0	1.0076	15.0	1.0095
0.1	1.0001	3.1	1.0020	6.1	1.0039	9.1	1.0058	12.1	1.0077	15.1	1.0095
0.2	1.0001	3.2	1.0020	6.2	1.0039	9.2	1.0058	12.2	1.0077	15.2	1.0096
0.3	1.0002	3.3	1.0021	6.3	1.0040	9.3	1.0059	12.3	1.0078	15.3	1.0097
0.4	1.0003	3.4	1.0021	6.4	1.0040	9.4	1.0059	12.4	1.0078	15.4	1.0097
0.5	1.0003	3.5	1.0022	6.5	1.0041	9.5	1.0060	12.5	1.0079	15.5	1.0098
0.6	1.0004	3.6	1.0023	6.6	1.0042	9.6	1.0061	12.6	1.0080	15.6	1.0099
0.7	1.0004	3.7	1.0023	6.7	1.0042	9.7	1.0061	12.7	1.0080	15.7	1.0099
0.8	1.0005	3.8	1.0024	6.8	1.0043	9.8	1.0062	12.8	1.0081	15.8	1.0100
0.9	1.0006	3.9	1.0025	6.9	1.0044	9.9	1.0063	12.9	1.0082	15.9	1.0101
1.0	1.0006	4.0	1.0025	7.0	1.0044	10.0	1.0063	13.0	1.0082	16.0	1.0101
1.1	1.0007	4.1	1.0026	7.1	1.0045	10.1	1.0064	13.1	1.0083	16.1	1.0102
1.2	1.0008	4.2	1.0027	7.2	1.0046	10.2	1.0064	13.2	1.0083	16.2	1.0102
0.1	1.0001	4.3	1.0027	7.3	1.0046	10.3	1.0065	13.3	1.0084	16.3	1.0103
1.4	1.0009	4.4	1.0028	7.4	1.0047	10.4	1.0066	13.4	1.0085	16.4	1.0104
1.5	1.0009	4.5	1.0028	7.5	1.0047	10.5	1.0066	13.5	1.0085	16.5	1.0104
1.6	1.0010	4.6	1.0029	7.6	1.0048	10.6	1.0067	13.6	1.0086	16.6	1.0105
1.6	1.0010	4.7	1.0030	7.7	1.0049	10.7	1.0068	13.7	1.0087	16.7	1.0106
1.8	1.0011	4.8	1.0030	7.8	1.0049	10.8	1.0068	13.8	1.0087	16.8	1.0106
1.9	1.0012	4.9	1.0031	7.9	1.0050	10.9	1.0069	13.9	1.0088	16.9	1.0107
2.0	1.0013	5.0	1.0032	8.0	1.0051	11.0	1.0070	14.0	1.0089	17.0	1.0107
2.1	1.0013	5.1	1.0032	8.1	1.0051	11.1	1.0070	14.1	1.0089	17.1	1.0108
2.2	1.0014	5.2	1.0033	8.2	1.0052	11.2	1.0071	14.2	1.0090	17.2	1.0109
2.3	1.0015	5.3	1.0034	8.3	1.0052	11.3	1.0071	14.3	1.0090	17.3	1.0109
2.4	1.0015	5.4	1.0034	8.4	1.0053	11.4	1.0072	14.4	1.0091	17.4	1.0110
2.5	1.0016	5.5	1.0035	8.5	1.0054	11.5	1.0073	14.5	1.0092	17.5	1.0111
2.6	1.0016	5.6	1.0035	8.6	1.0054	11.6	1.0073	14.6	1.0092	17.6	1.0111
2.7	1.0017	5.7	1.0036	8.7	1.0055	11.7	1.0074	14.7	1.0093	17.7	1.0112
2.8	1.0018	5.8	1.0037	8.8	1.0056	11.8	1.0075	14.8	1.0094	17.8	1.0113
2.9	1.0018	5.9	1.0037	8.9	1.0056	11.9	1.0075	14.9	1.0094	17.9	1.0113
3.0	1.0019	6.0	1.0038	9.0	1.0057	12.0	1.0076	15.0	1.0095	18.0	1.0114

Table C-1. Table of Tritium Compressibility Factors at 295 K (continued)

$$Z_{(T_2)} = 1 + \{[(P_{\text{atm}} \times 760) \times 0.000832]/1000\}$$

P (atm)	z(T2)	P (atm)	z(T2)	P (atm)	z(T2)	P (atm)	z(T2)	P (atm)	z(T2)	P (atm)	z(T2)
18.0	1.0114	21.0	1.0133	24.0	1.0152	27.0	1.0171	30.0	1.0190	33.0	1.0209
18.1	1.0114	21.1	1.0133	24.1	1.0152	27.1	1.0171	30.1	1.0190	33.1	1.0209
18.2	1.0115	21.2	1.0134	24.2	1.0153	27.2	1.0172	30.2	1.0191	33.2	1.0210
18.3	1.0116	21.3	1.0135	24.3	1.0154	27.3	1.0173	30.3	1.0192	33.3	1.0211
18.4	1.0116	21.4	1.0135	24.4	1.0154	27.4	1.0173	30.4	1.0192	33.4	1.0211
18.5	1.0117	21.5	1.0136	24.5	1.0155	27.5	1.0174	30.5	1.0193	33.5	1.0212
18.6	1.0118	21.6	1.0137	24.6	1.0156	27.6	1.0175	30.6	1.0193	33.6	1.0212
18.7	1.0118	21.7	1.0137	24.7	1.0156	27.7	1.0175	30.7	1.0194	33.7	1.0213
18.8	1.0119	21.8	1.0138	24.8	1.0157	27.8	1.0176	30.8	1.0195	33.8	1.0214
18.9	1.0120	21.9	1.0138	24.9	1.0157	27.9	1.0176	30.9	1.0195	33.9	1.0214
19.0	1.0120	22.0	1.0139	25.0	1.0158	28.0	1.0177	31.0	1.0196	34.0	1.0215
19.1	1.0121	22.1	1.0140	25.1	1.0159	28.1	1.0178	31.1	1.0197	34.1	1.0216
19.2	1.0121	22.2	1.0140	25.2	1.0159	28.2	1.0178	31.2	1.0197	34.2	1.0216
19.3	1.0122	22.3	1.0141	25.3	1.0160	28.3	1.0179	31.3	1.0198	34.3	1.0217
19.4	1.0123	22.4	1.0142	25.4	1.0161	28.4	1.0180	31.4	1.0199	34.4	1.0218
19.5	1.0123	22.5	1.0142	25.5	1.0161	28.5	1.0180	31.5	1.0199	34.5	1.0218
19.6	1.0124	22.6	1.0143	25.6	1.0162	28.6	1.0181	31.6	1.0200	34.6	1.0219
19.7	1.0125	22.7	1.0144	25.7	1.0163	28.7	1.0181	31.7	1.0200	34.7	1.0219
19.8	1.0125	22.8	1.0144	25.8	1.0163	28.8	1.0182	31.8	1.0201	34.8	1.0220
19.9	1.0126	22.9	1.0145	25.9	1.0164	28.9	1.0183	31.9	1.0202	34.9	1.0221
20.0	1.0126	23.0	1.0145	26.0	1.0164	29.0	1.0183	32.0	1.0202	35.0	1.0221
20.1	1.0127	23.1	1.0146	26.1	1.0165	29.1	1.0184	32.1	1.0203	35.1	1.0222
20.2	1.0128	23.2	1.0147	26.2	1.0166	29.2	1.0185	32.2	1.0204	35.2	1.0223
20.3	1.0128	23.3	1.0147	26.3	1.0166	29.3	1.0185	32.3	1.0204	35.3	1.0223
20.4	1.0129	23.4	1.0148	26.4	1.0167	29.4	1.0186	32.4	1.0205	35.4	1.0224
20.5	1.0130	23.5	1.0149	26.5	1.0168	29.5	1.0187	32.5	1.0206	35.5	1.0224
20.6	1.0130	23.6	1.0149	26.6	1.0168	29.6	1.0187	32.6	1.0206	35.6	1.0225
20.7	1.0131	23.7	1.0150	26.7	1.0169	29.7	1.0188	32.7	1.0207	35.7	1.0226
20.8	1.0132	23.8	1.0150	26.8	1.0169	29.8	1.0188	32.8	1.0207	35.8	1.0226
20.9	1.0132	23.9	1.0151	26.9	1.0170	29.9	1.0189	32.9	1.0208	35.9	1.0227
21.0	1.0133	24.0	1.0152	27.0	1.0171	30.0	1.0190	33.0	1.0209	36.0	1.0228

To determine the component in the gas and the number of moles of each component in the gas, a sample of the container gas is analyzed, and the mole percent of each gas is determined. This gas analysis results in a number for each component in the mixture, which represents the mole percent of each gas at the time of the analysis. The mole percent (m%) is calculated by

$$m\%_{(\text{component})} = (\text{Moles of a component} / \text{Moles Total}) \times 100$$

Therefore, the Mole Percent Total ($m\%_{(\text{Total})}$) is

$$m\%_{(\text{Total})} = 100 = m\%_{(T_2)} + m\%_{(HT)} + m\%_{(DT)} + m\%_{(CT_4)} + m\%_{(qTw)} + m\%_{(He-3)} + m\%_{(N_2)} + m\%_{(O_2)} + m\%_{(\text{etc.})}$$

The number of moles of each gas component in the container is calculated by

$$n_{(\text{Moles of Component})} = (m\%_{(\text{component})} / 100) \times n_{(\text{Total Moles})}$$

The grams of each component can then be calculated using the formula

$$\text{Grams of Component} = (m\%_{(\text{component})} / 100) \times (n_{(\text{Total Moles})}) \times (\text{Gram Molecular Weight of Component})$$

The following is the process used to determine the number of moles and grams of tritium in the HT component in a container.

1. Calculate the total moles of material in the container.
2. Analyze the sample using a mass spectrometer to determine the mole percent of HT.
3. Calculate the number of moles of HT in the container.
4. Calculate the number of grams of HT in the container.
5. Multiply the moles of HT by $\frac{1}{2}$ to determine the moles of T_2 in the HT component.
6. Multiply the moles of HT by $\frac{1}{2}$ and by the gram molecular weight of tritium to determine the grams of tritium in the HT component.

In steps 5 and 6, the $\frac{1}{2}$ is used because it is the ratio of the number of tritium atoms in HT to the number of tritium atoms in T_2 ($HT/T_2 = 1/2$).

The percent tritium in the container is the sum of the mole percent of each tritium component multiplied by the number of moles of tritium per mole of the tritium component. The moles of tritium per mole of component is equal to the ratio of the number of tritium atoms in the component chemical formula to the number of tritium atoms in T_2 ; i.e., 2. This can be expressed as the following formula:

$$m\%_{(\text{Tritium Per Mole Total})} = \frac{2}{2} m\%_{(T_2)} + \frac{1}{2} m\%_{(HT)} + \frac{1}{2} m\%_{(DT)} + \frac{4}{2} m\%_{(CT_4)} + \frac{2w}{2} m\%_{(qT_w)} + \text{etc.}$$

The moles of tritium in the container are the sum of the moles of tritium contained in each component in the container. This is calculated using the following equation, which is the ratio of the tritium atoms in the component chemical formula to the tritium atoms in T_2 ; i.e., 2. In the formula qT_w/T_2 this would be $w/2$, or in HT/T_2 this would be $1/2$.

$$\begin{aligned} \text{Moles of Tritium} = & [(m\%_{(T_2)}/100) \times (T_2/T_2) \times n_{(\text{Moles Total})}] + [(m\%_{(HT)}/100) \times (HT/T_2) \times n_{(\text{Moles Total})}] \\ & + [(m\%_{(DT)}/100) \times (DT/T_2) \times n_{(\text{Moles Total})}] + [(m\%_{(CT_4)}/100) \times (CT_4/T_2) \times n_{(\text{Moles Total})}] \\ & + [(m\%_{(qT_w)}/100) \times (qT_w/T_2) \times n_{(\text{Moles Total})}] + \dots \end{aligned}$$

where x/T_2 is the number of moles of tritium per mole of the tritium component.

Factoring out $n_{(\text{Moles Total})}/100$ and rearranging, the equation becomes

$$\begin{aligned} (\text{Moles of Tritium} \times 100) / (n_{(\text{Moles Total})}) &= (m\%_{(T_2)} + m\%_{(HT)} \times 1/2 + m\%_{(DT)} \times 1/2 + m\%_{(CT_4)} \times 2 + \\ & m\%_{(qT_w)} \times w/2 + \text{etc.}) \\ &= m\%_{(\text{Tritium Per Mole Total})} \end{aligned}$$

Rearranging the equation becomes

$$\text{Moles of Tritium} = (n_{(\text{Moles Total})} \times m\%_{(\text{Tritium Per Mole Total})})/100$$

The amount of tritium in grams is obtained by multiplying the moles of tritium obtained in the last equation by the gram molecular weight of tritium (6.0321g).

As an example, the grams of tritium in a shipment of research grade tritium are determined using the following process.

An analysis of a shipment of research grade gaseous tritium shows the following:

Component	Percent
T ₂	99.704
D ₂	0.115
DT	0.079
HT	0.050
HD	0.023
³ He	0.016
Ar	0.012
N ₂	0.010
H ₂	0.005

The container pressure is 742 mm, temperature is 20°C, and volume is 49.348 liters. This gives a compressibility factor ($z_{(T_2)}$) of 1.0006 and the constant, R, is 62.3631.

Calculating the percent tritium is as follows:

$$\begin{aligned} m\%_{(\text{Tritium Per Mole Total})} &= m\%_{(T_2)} + m\%_{(HT)} \times 1/2 + m\%_{(DT)} \times 1/2 \\ &= 99.704 + (0.050 \times 1/2) + (0.079 \times 1/2) \\ &= 99.704 + 0.025 + 0.0395 \\ &= 99.7685 \text{ percent} \end{aligned}$$

The number of moles of gas in the container is calculated by

$$\begin{aligned} n_{(\text{Moles Total})} &= PV/zRT \\ &= (742 \times 49.348)/(1.0006 \times 62.3631 \times 293.15) \\ &= 2.002 \text{ moles total} \end{aligned}$$

The amount of tritium in grams is

$$\begin{aligned} \text{Grams of Tritium} &= (n_{(\text{Moles Total})} \times m\%_{(\text{Tritium Per Mole Total})} \times 6.0321)/100 \\ &= (2.002 \times 6.0321 \times 99.7685)/100 \\ &= 12.046 \text{ grams tritium} \end{aligned}$$

The determination of the amount of tritium is only for the point in time that the sample was analyzed as a result of the decay of tritium. Over time, the number of moles of the gases containing tritium decrease. The pressure and number of moles of non-tritiated gases increase with time due to the ³He produced and the molecules formed by the atoms of other materials released when the tritium decays. Therefore, the mole percent and number of moles of gas in

the container and sample change with time. Figure C-1 shows an example of the changing moles in a gas mixture.

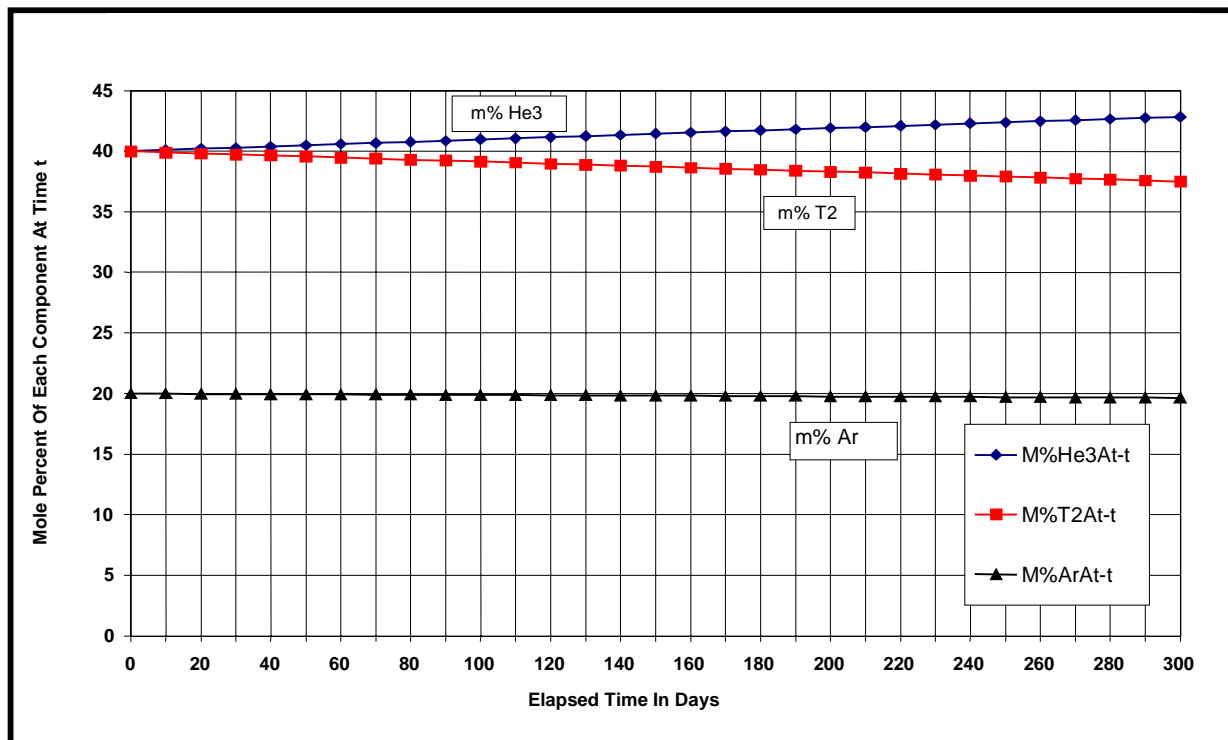

FIGURE C-1. Change in mole percent with time in a mixture of 40% T₂, 40% ³He and 20% Ar

The total number of moles in the container is known at the time of the sampling but not at the time of the analysis. If the gas analysis is performed on the same day as the sampling, then, since the half-life of tritium is 4500.88 days, the error caused by the decay is small (< 0.015 percent for 1 day, approximately 1 percent in 67 days). Some facilities are equipped to perform the sample analysis within a few minutes or on the same day as the sampling. Others facilities must depend upon collecting a gas sample, on the sampling date, for analysis at a later date.

The following equations include three significant dates. The Sample Date is the day the gas sample for analysis is collected, and the pressure, volume, and temperature of the container are measured and recorded to determine the total moles of gas. The Analysis Date is the date the gas sample is analyzed to determine the mole percent of tritium per mole in the sample. The Book Value Date is a date on which the quantity of tritium in the container is known from a previous assay. Additionally, it assumes a gaseous mixture at the start of 100% tritium and other stable gases; i.e., it does not contain HT, DT, HTO, or other radioactive or non-inert gases.

The process steps are as follows:

1. Calculating the number of moles of gas in the container on the Sampling Date.
2. Determining the percent of tritium in the collected sample on the Analysis Date by gas analysis.
3. Using the two values in steps 1 and 2, the time period, in days, between the two dates and the half-life of tritium, calculating the number of grams of tritium in the container on the Sampling Date.

Once the quantity of tritium in the container on the Sampling Date is known, the quantity of tritium in the container for any other date, including the Book Value Date can be calculated.

The number of moles of gas in the container on the Sampling Date ($n_{(TotCSmplDa)}$) is the sum of the number of moles of the non-tritiated gases present in the container, which do not change with time due to decay, ($n_{(Non-tritium)}$), plus the number of moles of tritium in the container at the time of the sampling ($n_{(T_2CSmplDa)}$). In equation form

$$\begin{aligned} PV/zRT &= n_{(TotCSmplDa)} \\ &= n_{(Non-tritium)} + n_{(T_2CSmplDa)} \end{aligned}$$

Rearranging the equation it becomes

$$n_{(Non-tritium)} = n_{(TotCSmplDa)} - n_{(T_2CSmplDa)} \quad \{1\}$$

The total number of moles of material in the container on the Analysis Date, ($n_{(TotCAnlDa)}$) is

$$n_{(TotCAnlDa)} = n_{(Non-tritium)} + n_{(T_2CSmplDa)} \times e^{((t \ln(0.5))/4500.88)} + 2 \times (n_{(T_2CSmplDa)} - n_{(T_2CSmplDa)} e^{((t \ln(0.5))/4500.88)})$$

where $n_{(Non-tritium)}$ = sum of the moles of the other gases
 $(n_{(T_2CSmplDa)} \times e^{((t \ln(0.5))/4500.88)})$ = number of moles of T_2 decayed
 $2 \times (n_{(T_2CSmplDa)} - n_{(T_2CSmplDa)} e^{((t \ln(0.5))/4500.88)})$ = number of moles of 3He created
 t = time between the Sampling Date and Analysis Date in days

Factoring, the equation becomes

$$n_{(TotCAnlDa)} = n_{(Non-tritium)} + n_{(T_2CSmplDa)} \times (2 - e^{((t \ln(0.5))/4500.88)}) \quad \{2\}$$

On the day the gas analysis is performed, the mole percent of tritium ($m\%_{(T_2MAnlDa)}$) is determined by gas analysis. The equation is

$m\%_{(T_2MAnlDa)}$ is equal to the number of moles of tritium on the sampling date decayed to the analysis date; i.e., ($n_{(T_2CSmplDa)} \times e^{((t \ln(0.5))/4500.88)})$ divided by the number of moles in the sampled container on the analysis date; i.e., ($n_{(TotCAnlDa)}$) multiplied by 100 to convert it to percent.

$$m\%_{(T_2MAnlDa)} = \{(n_{(T_2CSmplDa)} e^{((t \ln(0.5))/4500.88)}) / n_{(TotCAnlDa)}\} \times 100$$

where $(n_{(T_2CSmplDa)} \times e^{((t \ln(0.5))/4500.88)})$ = number of decayed moles of T
 $(n_{(TotCAnlDa)})$ = number of moles in the sample on the Analysis Date
 t = time between the Sampling Date and Analysis Date in days

days

Rearranging the equation it becomes

$$n_{(TotCAnlDa)} = \{(n_{(T_2CSmplDa)} e^{((t \ln(0.5))/4500.88)}) / m\%_{(T_2MAnlDa)}\} \times 100 \quad \{3\}$$

Substituting Equation {1} into Equation {2}, we have

$$n_{(TotCA\text{nlDa})} = n_{(TotCS\text{mplDa})} - n_{(T_2CS\text{mplDa})} + n_{(T_2CS\text{mplDa})} \times (2 - e^{((t \times \ln(0.5))/4500.88)})$$

Rearranging the equation, it becomes

$$n_{(TotCA\text{nlDa})} = n_{(TotCS\text{mplDa})} + n_{(T_2CS\text{mplDa})} \times (1 - e^{((t \times \ln(0.5))/4500.88)}) \quad \{4\}$$

Substituting Equation {3} into Equation {4}, we have

$$100 (n_{(T_2CS\text{mplDa})} e^{((t \times \ln(0.5))/4500.88)}) / m\%_{(T_2MA\text{nlDa})} = n_{(TotCS\text{mplDa})} + n_{(T_2CS\text{mplDa})} (1 - e^{((t \times \ln(0.5))/4500.88)})$$

Multiplying through by $m\%_{(T_2MA\text{nlDa})}$, it becomes

$$100 (n_{(T_2CS\text{mplDa})} e^{((t \times \ln(0.5))/4500.88)}) = m\%_{(T_2MA\text{nlDa})} n_{(TotCS\text{mplDa})} + m\%_{(T_2MA\text{nlDa})} n_{(T_2CS\text{mplDa})} (1 - e^{((t \times \ln(0.5))/4500.88)})$$

Rearranging and factoring, we have

$$n_{(T_2CS\text{mplDa})} = \frac{(n_{(TotCS\text{mplDa})} \times m\%_{(T_2MA\text{nlDa})}) / (e^{((t \times \ln(0.5))/4500.88)} \times (100 + m\%_{(T_2MA\text{nlDa})})) - m\%_{(T_2MA\text{nlDa})}}{m\%_{(T_2MA\text{nlDa})}}$$

The quantity of tritium in grams is then the number of moles of tritium on the Sampling Date, $n_{(T_2CS\text{mplDa})}$, multiplied by the gram molecular weight of tritium (6.03210 g) or

$$\text{Grams } T_2 \text{ On Sampling Date} = \frac{6.0321 \times (PV/zRT) \times (m\%_{(T_2MA\text{nlDa})})}{[e^{((t \times \ln(0.5))/4500.88)} \times (100 + m\%_{(T_2MA\text{nlDa})})] - m\%_{(T_2MA\text{nlDa})}}$$

If a container has pure tritium mixed with other non-decaying and non-chemically reacting gases on the Book Value Date, sampled on the Sample Date and analyzed on the Analysis Date, then the gram of tritium in the container on the Sample Date can be calculated using the derived formula, the PV/zRT data and the $m\%_{(T_2MA\text{nlDa})}$ data measured on the Analysis Date.

Figure C-2 is a graph of the changes in the moles of material taking place in a container of pure T_2 versus time over a period of six tritium half-lives. The graph shows the moles of tritium decreasing from 1.0 and approaching 0.0, the ^3He increasing from 0.0 and approaching 2.0, and the total moles increasing from 1.0 and approaching 2.0.

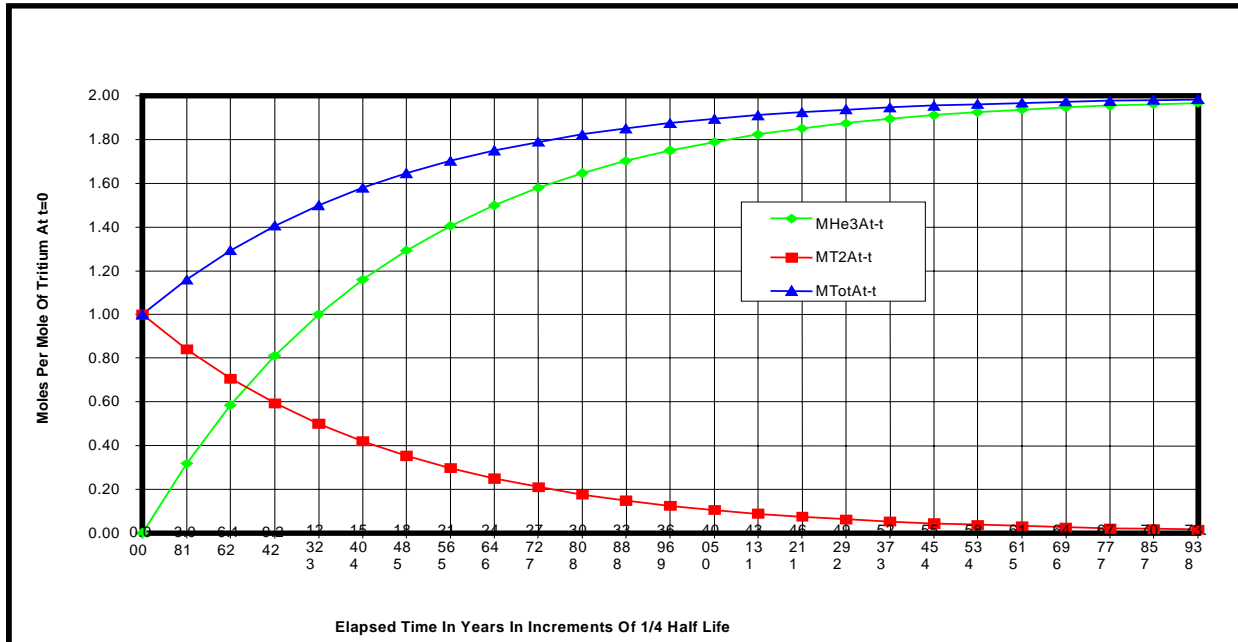

FIGURE C-2. Moles of T₂ and ³He versus time

Similar formulas can be derived for other two-component gases, such as HT mixed with other non-tritiated gases and DT mixed with other non-tritiated gases. See Figures C-3 to C-6 for other examples.

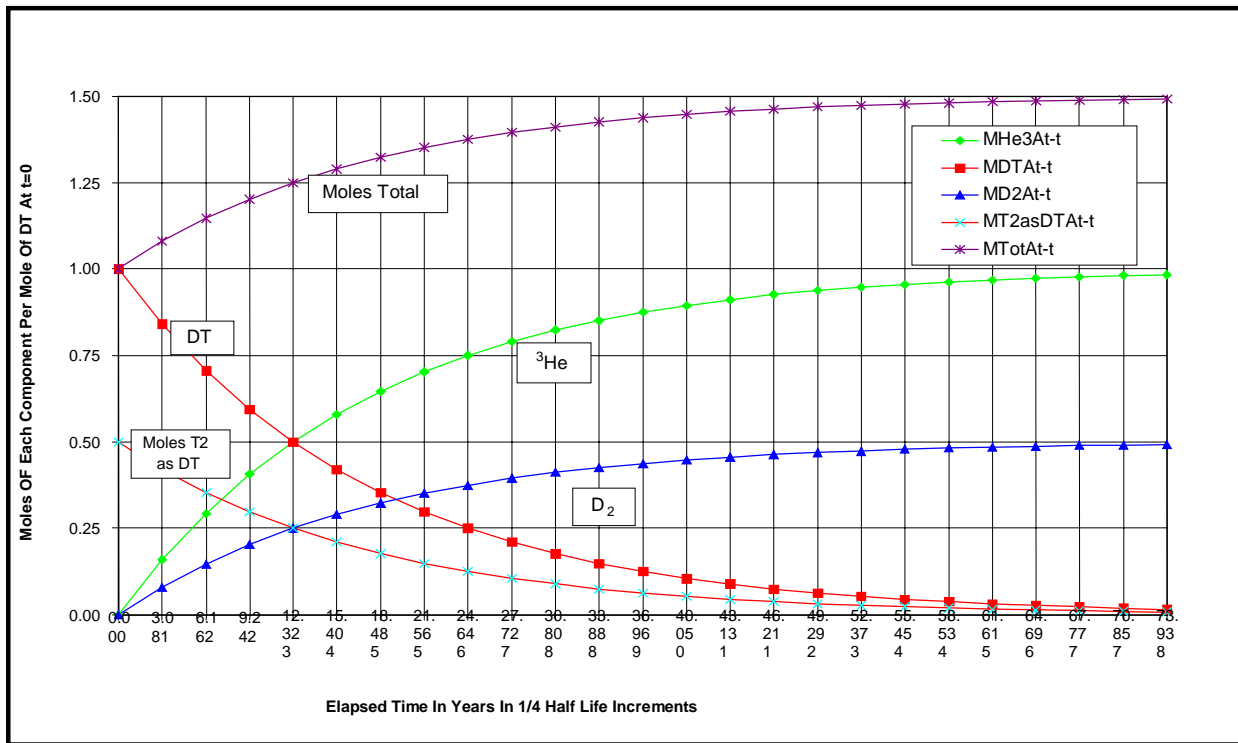

FIGURE C-3. Moles of DT, ³He,

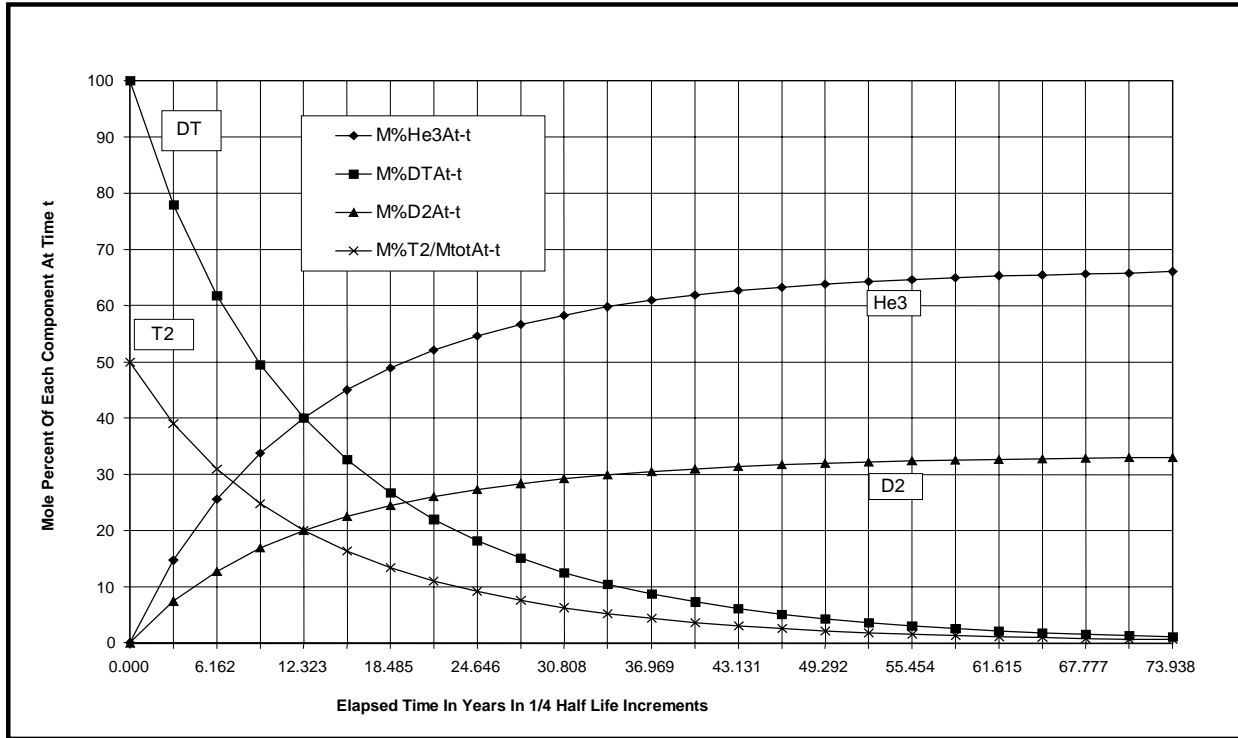

FIGURE C-4. Mole percent of T₂, D₂, DT, and ³He versus time

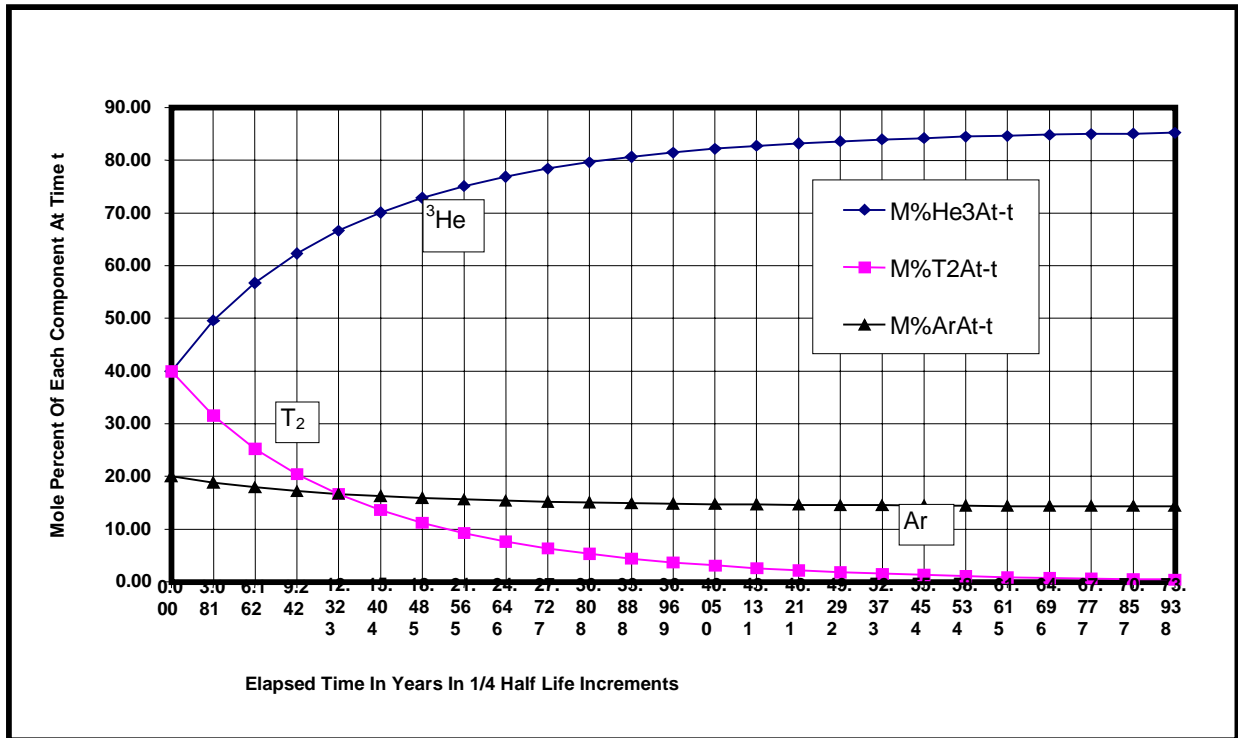

FIGURE C-5. 40% T₂, 40% ³He, and 20% Ar - Changes in mole percent of components versus time

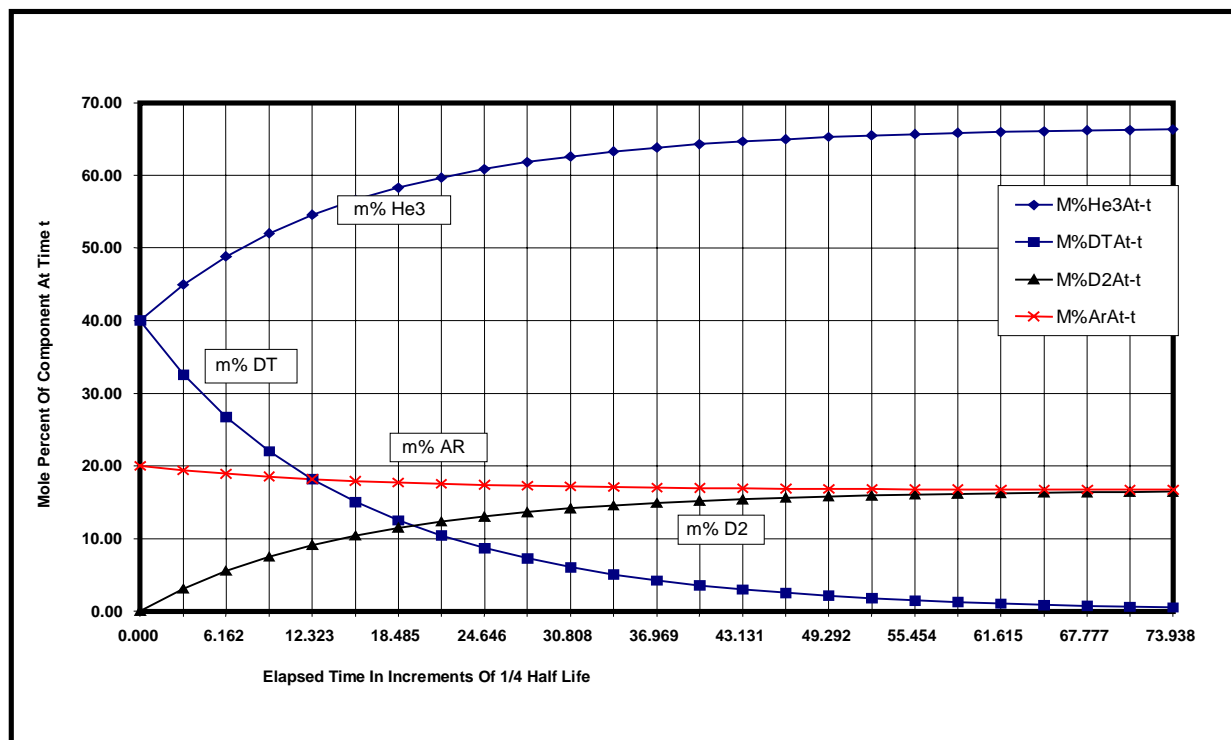

FIGURE C-6. 40% DT, 40% ^3He , and 20% Ar, Change in mole percent of each component versus time

C.3 Calorimetry Assay

Calorimetry is the quantitative measurement of heat. A calorimeter is an apparatus for measuring heat quantities generated in or emitted by materials in processes such as chemical reaction, changes of state, and formation of solutions. Heat is generally measured in calories or joules. A calorie is a unit of heat energy equal to the heat energy required to raise the temperature of a gram of water from 14.5 to 15.5°C, at a constant pressure of 1 atmosphere. A calorie is equal to 4.186 joules.

A calorimeter designed to be used in processes that continually generate heat (power sources) and measures power instead of heat is called a Constant Heat Flow (CHF) calorimeter. A CHF calorimeter measures the power (joules/second) of a source not the heat output (joules) of a source. The power is usually measured in Watts, which is a unit of power equal to 1 joule/second.

A radioactive material is a power source, which deposits the energy due to decay in the radioactive material itself and in the materials surrounding the radioactive material. The power generated by the decay of tritium has been measured and is equal to 0.3240 ± 0.0009 Watts/gram of tritium.

Mound Laboratory has been the leader in the design, fabrication, calibration, and operation of CHF calorimeters for many years. Mound has specialized in the development of CHF calorimeters to be used in the measurement of radioactive material quantities by measuring their power output. CHF calorimeters are generally designed to meet the specific needs of the items to be assayed and are limited in application by the following:

DOE-HDBK-1129-99

- Physical size of the calorimeter measurement chamber,
- Wattage range of the measurement system,
- Precision and accuracy of the measurement for the size and wattage range of the item to be measured,
- Throughput or number of samples to be measured per day.

CHF calorimeters have been designed in many different configurations, such as over/under, and twin. Most CHF systems in use today use digital control systems operated by a stored program and are easy to operate. The steps in making a CHF measurement are generally as follows:

- Install a dummy mass in the calorimeter container, pack steel or copper wool around the dummy mass, and install it in the measurement chamber.
- Make a zero baseline run at a wattage level (W_{zbl}), which is at a wattage level greater than the unknown wattage level of the sample to be measured.
- During the baseline run, the digital control system establishes a calorimeter bridge voltage value for a known (W_{zbl}) wattage input.
- Remove the calorimeter container from the measurement chamber, remove the dummy sample from the container, replace it with the sample to be measured, place it back in the measurement chamber, and make an unknown sample run.
- During the unknown sample run, the digital control system decreases the power in the calorimeter until the bridge voltage is the same as that measured in the zero baseline run.
- The power input to the calorimeter during this unknown sample run (W_{usr}) is measured.
- The power of the sample being measured (W_s) is calculated by subtracting the wattage value measured during the zero baseline run from the wattage measured during the unknown sample run to find the wattage of the sample. In equation form:

$$W_s = W_{zbl} - W_{usr}$$

The calorimeter factor for tritium used at most DOE sites for the purposes of reporting accountable quantities of tritium to DOE is 0.3240 +/- 0.0009 Watts/g of tritium.

CHF calorimetry can be used to measure tritium in solid form. CHF is the most accurate method available for the measurement of tritium quantities if the chamber size and wattage level of the item to be measured are well matched to the specifications of the CHF system being used. CHF systems, however

- Do not provide any information about the different gases present in a container (HT, DT H₂, D₂, ³He, etc.),
- Only measure the quantity of tritium in the container,
- Are not currently available for items larger than 11 inches in diameter and 16 inches long
- Take several hours to complete a single measurement.

This page is intentionally blank.

APPENDIX D: CONTAMINATION AND SURFACE ACTIVITY THRESHOLDS

D.1 Appendix D to Part 835 - Surface Radioactivity Values

The data presented in Appendix D are to be used in identifying contamination and high contamination areas as defined in Sec. 835.2(a), identifying the need for surface contamination monitoring and control in accordance with Sec. 835.404, identifying the need for radioactive material controls in accordance with Sec. 835.1101.

Surface Radioactivity Values {1}
[In dpm/100 cm²]

Radionuclide	Removable {2}, {4}	Total (fixed + removable) {2}, {3}
U-nat, U-235, U-238, and associated decay products	1,000	5,000
Transuranics, Ra-226, Ra-228, Th-230, Th-228, Pa-231, Ac-227, I-125, I-129	20	500
Th-nat, Th-232, Sr-90, Ra-223, Ra-224, U-232, I-126, I-131, I-133	200	1,000
Beta-gamma emitters (nuclides with decay modes other than alpha emission or spontaneous fission) except Sr-90 and others noted above {5}	1,000	5,000
Tritium and tritiated compounds {6}	10,000	N/A

{1} The values in this Appendix, with the exception noted in footnote 6, apply to radioactive contamination deposited on, but not incorporated into the interior of, the contaminated item. Where surface contamination by both alpha- and beta-gamma-emitting nuclides exists, the limits established for alpha- and beta-gamma-emitting nuclides apply independently.

{2} As used in this table, dpm (disintegrations per minute) means the rate of emission by radioactive material as determined by correcting the counts per minute observed by an appropriate detector for background, efficiency, and geometric factors associated with the instrumentation.

{3} The levels may be averaged over one square meter provided the maximum surface activity in any area of 100 cm² is less than three times the value specified. For purposes of averaging, any square meter of surface should be considered to be above the surface radioactivity value if (1) from measurements of a representative number of sections it is determined that the average contamination level exceeds the applicable value; or (2) it is determined that the sum of the activity of all isolated spots or particles in any 100 cm² area exceeds three times the applicable value.

{4} The amount of removable radioactive material per 100 cm² of surface area should be determined by swiping the area with dry filter or soft absorbent paper, applying moderate pressure, and then assessing the amount of radioactive material on the swipe with an appropriate instrument of known efficiency. (Note—The use of dry material may not be appropriate for tritium.) When removable contamination on objects of surface area less than 100 cm² is determined, the activity per unit area should be based on the actual area, and the entire surface should be wiped. It is not necessary to use swiping techniques to measure removable contamination levels if direct scan surveys indicate that the total residual surface contamination levels are within the limits for removable contamination.

{5} This category of radionuclides includes mixed fission products, including the Sr-90 which is present in them. It does not apply to Sr-90 which has been separated from the other fission products or mixtures where the Sr-90 has been enriched.

{6} Tritium contamination may diffuse into the volume or matrix of materials. Evaluation of surface contamination should consider the extent to which such contamination may migrate to the surface in order to ensure the surface radioactivity value provided in this Appendix is not exceeded. Once this contamination migrates to the surface, it may be removable, not fixed, therefore a "Total" value does not apply.

D.2 “Response to Questions and Clarification of Requirements and Processes: DOE 5400.5, Section II.5 and Chapter IV Implementation (Requirements Relating to Residual Radioactive Materials)”, dated November 17, 1995, DOE, Office of Assistant Secretary for Environmental, Safety and Health Office of Environment

TABLE 1 SURFACE ACTIVITY GUIDELINES
Allowable Total Residual Surface Activity (dpm/100 cm²)⁴

Radionuclides ⁵	Average ^{6/7}	Maximum ^{8/9}	Removable ⁹
Group 1 – Transuranics, I-125, I-129, Ac-227, Ra-226, Ra-228, Th-228, Th-230, Pa-231	100	300	20
Group 2 – Th-natural, Sr-90, I-126, I-131, I-133, Ra-223, Ra-224, U-232, Th-232	1,000	3,000	200
Group 3 – U-natural, U-235, U-238, and associated decay products, alpha emitters	5,000	15,000	1,000
Group 4 – Beta-gamma emitters (radionuclides with decay modes other than alpha emission or spontaneous ¹⁰ fission) except Sr-90 and others noted above ⁷	5,000	15,000	1,000
Tritium (applicable to surface and subsurface) ¹¹	N/A	N/A	10,000

- 4 As used in this table, dpm (disintegrations per minute) means the rate of emission by radioactive material as determined by counts per minute measured by an appropriate detector for background, efficiency, and geometric factors associated with the instrumentation.
- 5 Where surface contamination by both alpha- and beta-gamma-emitting radionuclides exists, the limits established for alpha- and beta-gamma-emitting radionuclides should apply independently.
- 6 Measurements of average contamination should not be averaged over an area of more than 1 m². For objects of smaller surface area, the average should be derived for each such object.
- 7 The average and maximum dose rates associated with surface contamination resulting from beta-gamma emitters should not exceed 0.2 mrad/h and 1.0 mrad/h, respectively, at 1 cm.
- 8 The maximum contamination level applies to an area of not more than 100 cm².
- 9 The amount of removable material per 100 cm² of surface area should be determined by wiping an area of that size with dry filter or soft absorbent paper, applying moderate pressure, and measuring the amount of radioactive material on the wiping with an appropriate instrument of known efficiency. When removable contamination on objects of surface area less than 100 cm² is determined, the activity per unit area should be based on the actual area, and the entire surface should be wiped. It is not necessary to use wiping techniques to measure removable contamination levels if direct scan surveys indicate that the total residual surface contamination levels are within the limits for removable contamination.
- 10 This category of radionuclides includes mixed fission products, including the Sr-90 that is present in them. It does not apply to Sr-90 that has been separated from the other fission products or mixtures where the Sr-90 has been enriched.
- 11 Property recently exposed or decontaminated should have measurements (smears) at regular time intervals to ensure that there is not a build-up of contamination over time. Because tritium typically penetrates material it contacts, the surface guidelines in Group 4 are not applicable to tritium. The Department has reviewed the analysis conducted by the DOE Tritium Surface Contamination Limits Committee (“Recommended Tritium Surface Contamination Release Guides,” February 1991), and has assessed potential doses associated with the release of property containing residual tritium. The Department recommends the use of the stated guideline as an interim value for removable tritium. Measurements demonstrating compliance of the removable fraction of tritium on surfaces with this guideline are acceptable to ensure that non-removable fractions and residual tritium in mass will not cause exposures that exceed DOE dose limits and constraints.

APPENDIX E: RESOURCES USED IN WRITING THIS HANDBOOK

1. U.S. Environmental Protection Agency's Federal Guidance Report No. 11, Table 1 "Limiting Values of Radionuclide Intake and Air Concentration and Dose Conversion Factors for Inhalation, Submersion, and Ingestion," September 1988.
2. Villagran, J.E., Whillians, D.W., "Radiation Dose to Lung Cell Populations Resulting from the Inhalation of Titanium Tritide Particles," presented at the Health Physics Society Meeting in New Orleans, 1984.
3. McConville, G.T., Wood, C.M., Calculation of Tritium Dose from Insoluble Particulates, Fusion Technology, Vol. 28, pp. 905-909, October 1995.
4. De Ras, E.M.M., Vaane, J.P., Van Suetendael, W., Investigation of the Nature of Contamination Caused by Tritium Targets Used for Neutron Production, CEC-JRC, Central Bureau for Nuclear Measurements, Geel, Belgium, published in 5th International Congress of the International Radiation Protection Association (IRPA) Volume 1, held in Jerusalem, Israel, March 1980.
5. International Commission of Radiological Protection, Publication 71, Age-dependent Doses to Members of the Public from Intake of Radionuclides: Part 4 – Inhalation Dose Coefficients, Oxford, Pergamon Press; 1995.
6. Heung, L.K., Titanium for Long Term Tritium Storage, WSRC-TR-94-0596, December 1994.
7. Drolet, T.S., Wong, K.Y., and Dinner, P.J., Canadian Experience with Tritium – The Basis of a New Fusion Project, Nuclear Technology/Fusion, Vol. 5, January 1984.
8. Kherani, N.P., and Shmayda, W.T., Bulk Getters for Tritium Storage, Ontario Hydro Research Division.
9. Shmayda, W.T. and Kherani, N.P., On the Unloading of Titanium Getter Beds, Ontario Hydro Research Division, Report No. 85-118-K, October 2, 1985.
10. Kherani, N.P., and Shmayda, W.T., Titanium Sponge for Immobilization Tritium Containers, Ontario Hydro Research Division, Report No. M85-120-K, December 19, 1985.
11. Noga, J.O., Investigations of Titanium and Zirconium Hydrides to Determine Suitability of Recoverable Tritium Immobilization for the Pickering Tritium Removal System, Ontario Hydro Research Division, Report No. 81-368-K, November 12, 1981.
12. Guidelines for Canadian Drinking Water Quality, 6th Edition, 1996, Health Canada Report, 96-EHD-196.
13. Preamble of the First Third Land Disposal Restrictions Final Rule, 53 FR 31149, August 17, 1988.
14. Memorandum, Environmental Protection Agency, Marcia E. Williams and Christina Kaneen to Robert L. Duprey, "Applicability of Bevill Amendment to the American Natural Gas Coal Gasification Facility," September 1987.

DOE-HDBK-1129-99

15. Letter, Marcia E. Williams, EPA, to G. N. Weinreich, ANG Coal Gasification Co., June 16, 1986.
16. Memorandum, Environmental Protection Agency, John H. Skinner to Harry Seraydarian, "Clarification of Mining Waste Exclusion," May 16, 1985.
17. RCRA Superfund Hotline Report, February 1985.
18. DOE-STD-1027-92 Change Notice 1, "Hazard Categorization and Accident Analysis Techniques for Compliance with DOE Order 5480.23, 'Nuclear Safety Analysis Reports,'" September 1997.
19. DOE Limited Standard, DOE-EM-STD-5502-94, "Hazard Baseline Documentation," August 1994.
20. "Implementation Guidance for Authorization Basis," DOE Office of Defense Programs, Revision 1, August 21, 1995.
21. William R. Wall, LLNL, "Estimating the Maximum Dose Due to a Tritium Release," White Paper, November 1997.
22. Memorandum, Department of Energy, Ohio Field Office, Nat Brown to Elizabeth L. Osheim, "Mound Commercial Business Employees – 'Public' Versus 'Co-Located,'" April 7, 1997.
23. P. D. Gildea, H. G. Birnbaum, and W. R. Wall, "Modification and Testing of the Sandia Laboratories, Livermore Tritium Decontamination Systems," Proceedings of the 15th DOE Nuclear Air Cleaning Conference, CONF-788019 Vol. I, August 1978.
24. "Tritium Facility Decommissioning, Pioneering Success at the Savannah River Plant," DOE/SR-5000-510, October 1997
25. John Gill, Babcock & Wilcox of Ohio, Personal Communication to Bill Weaver, July 1998
26. "Fire Risk Implications in Safety Analysis Reports," White Paper by D. A. Coutts, M. E. Bowman, C. E. Shogren, and M.J. Hitchler, WSMS, to be issued in February 1999
27. DOE Memorandum, from S. Blush, NS-1, to R. Claytor, DP-1 and P. Ziemer, EH-1, RTF Assessment of Fire Barriers, October 28, 1991
28. DOE Memorandum from Tom Rollow, Acting Director, Office of Nuclear Safety, to Neal Goldenberg, NE 70, "NS Response to Request for Deviation for Replacement Tritium Facility (RTF)," May 7, 1993
29. K.J. Hofstetter, et al., "Field Deployable Tritium Analysis System for Ground and Surface Water Measurements," accepted for publication in the Journal of Radioanalytical and Nuclear Chemistry.
30. N.P. Kherani, W.T. Shmayda, "Ionization Surface Activity Monitor for Tritium," Fusion Technology 28(3) (1995) 893.
31. W.T. Shmayda, N.P. Kherani, D. Stodilka, "Evaluation of the Tritium Surface Activity Monitor," Proceedings of the Symposium on Fusion Technology, Lisbon, 1996.

DOE-HDBK-1129-99

32. N.P. Kherani, W.T. Shmayda, "Monitor for Measuring the Radioactivity of a Surface," US and European patents pending.
33. SRS H1616 Hydride Transport Vessel Qualification Report (U), WSRC-RP-92-1161, Revision 2, 1995.
34. "Response to Questions and Clarification of Requirements and Processes: DOE 5400.5, Section II.5 and Chapter IV Implementation (Requirements Relating to Residual Radioactive Material)," DOE Office of the Assistant Secretary for Environmental Safety and Health, Office of Environment, November 17, 1995.
35. Robert H. Drake, "Recovery of Tritium from Tritiated Waste Water Cost Effectiveness Analysis," LA-UR-97-3767, Los Alamos National Laboratory, June 1996.
36. Scott Willms, "Deploying the Palladium Membrane Reactor for Concentrated Tritiated Water Processing," Technology Development Initiative, Los Alamos National Laboratory, May 5, 1997.
37. W. Kelly, DOE Defense Programs, Personal Communication to Bill Weaver, 1997.
38. Jack Metzler, DOE Defense Programs Personal Communication to Bill Weaver, 1997.
39. Robert Machacek, Ontario Hydro, Personal Communication to Bill Weaver, 1997.

This page is intentionally blank.

APPENDIX F: CHARTER OF THE TRITIUM FOCUS GROUP

GOALS – The goals of the TFG are to promote continuous, cost-effective improvement in safety and operations, and enhance the proactive management of the spectrum of Department of Energy (DOE) facilities handling tritium.

OBJECTIVES – The objectives of the TFG are to:

1. Provide a forum which fosters exchange of information and ideas, especially conduct of operations, lessons-learned, and root cause determinations;
2. Serve as a DOE-wide resource for tritium operations management with authority to conduct special studies, develop and propose guidelines and best practices for operations, and facilitate peer review of relevant documentation;
3. Develop consistency in implementation of as-low-as-reasonably-achievable (ALARA) programs and the assessment and reporting of risks and hazards;
4. Promote implementation of a staged and graded program of upgrades to facilities and procedures;
5. Promote sharing and application of state-of-the-art design and engineering technology and operating techniques in DOE; and
6. Develop consistency in terminology utilized in DOE tritium operations.

ORGANIZATION – A Tritium Operations Management Focus Group (TOMFG), consisting of the TFG Chairperson, Co-Chairperson, and Headquarters Program Managers and Facilities Management Division Directors, will review and approve TFG activities, including submittal of the initial Charter, and any revisions thereto, to the Program Secretarial Officers for final approval. The TOMFG shall serve as the principal Headquarters liaison and management element to facilitate successful operation of the TFG. The TFG membership will consist of the TOMFG, plus a DOE and contractor member and an alternate for each, to be designated by the respective management at each site responsible for the processing and handling of tritium. The members will be from organizational levels having cognizance over tritium operational aspects at their respective facilities, including processing, hazards, and improvement programs. The TFG will be chaired by a DOE Field Office representative and co-chaired by a contractor representative from the same site, as designated by the TOMFG in coordination with the appropriate Field Office Manager. The chairperson and co-chairperson will serve a 2-year term.

ADMINISTRATION – The TFG activities will receive sufficient management priority in terms of resource commitment to achieve the stated goals and objectives. Priorities will be established jointly between the respective DOE Program Managers and Facility Management Division Directors at Headquarters, and the DOE Field Office managers. The TFG shall look to the TOMFG to resolve any conflicts in site priorities and to achieve consensus guidelines and best practices proposed for approval by the DOE line organization.

MEETINGS – The TFG will meet on a periodic basis of at least two times per year. Meeting topics and agenda will be jointly developed by group members, and approved and issued by the Chairperson. Meeting locations will be rotated among the respective sites. DOE oversight organizations will be invited, as appropriate. As a minimum, the minutes of each meeting will be written and distributed to members within 10 days. The TOMFG will meet, as necessary, to assure timely action on proposals and continuity of the TFG efforts.

TRITIUM FOCUS SUBGROUPS (TFS) – The TFG will initiate formation of TFSs, as necessary, to recommend solutions to problems or concerns that may arise within the tritium complex. This may include the hosting of workshops to address issues such as implementation of specific XXX orders. Conclusions of the TFSs will be documented and distributed to TFG members. Proposals from the TFG will be provided through the TOMFG to appropriate DOE line management for approval.

TECHNICAL EXCHANGE – The TFG will encourage exchange of related technical information via meetings, conferences, and symposia.

DELIVERABLES – Initial deliverables will be timely communication and sharing of operational experiences among the facilities, meeting minutes, and proposals. Other deliverables will be developed in accordance with associate milestone schedules and IFS activity.

CHARTER REVIEW – The Charter will be reviewed annually and revised, as necessary.

Approved by:

Assistant Secretary for Defense Programs, DP-1

Date

(signed by) William H. Young _____
Assistant Secretary for Nuclear Energy, NE-1

12/24/91

Date

(signed by) Jill E. Lytle (EM-30) for _____
Assistant Secretary for Environmental
Restoration and Waste Management, EM-1

12/27/91

Date

(signed by) William Happer _____
Director of Energy Research

12/26/91

(signed by) Melvin H. Chiggioji (NP-3) for _____
Director of New Production Reactors, NP-1

12/26/91

This page is intentionally blank.

CONCLUDING MATERIAL

Review Activity:

DOE

DP

EE

EH

EM

ER

FE

GC

IG

NE

NN

PO

RW

Field Offices

AL

CH

GFO

ID

KC

NV

OH

OAK

OR

PG

RF

RL

SR

Preparing Activity:

EH-34

Project Number:

SAFT-0054

National Laboratories

ANL

BNL

FNAL

INEEL

LANL

LBNL

LLNL

NBL

ORNL

PNNL

PPPL

SNLA

Area Offices

AAO

CAO

FAO

KAO

LAAO

MAO

WVAO

Other Organizations

AMES

B&W OH

BN

BPA

BPO

DNFSB

EML

FDH

FDF

FETC

GJPO

LMES

M&H

ORAU

OSTI

SLAC

TJNAF

WAPA

WSLV

WSRC

